



MULTIMEDIA RECEIVER

Wireless Apple CarPlay & Android Auto™

USER MANUAL

AM7X

androidauto

Android Auto, Google Play, Android, are registered trademarks of Google, Inc. Bluetooth is a registered trademark of Bluetooth SIG, Inc.



Apple, Apple Car Play, Apple iPhone, Apple Music and Siri are registered trademarks of Apple, Inc.

Android Auto and Apple CarPlay is not owned or controlled by any car manufacturer and are not responsible for the privacy practices of third parties or the terms and conditions under which they offer such products. We strongly encourage you to read the Android Auto or Apple CarPlay privacy policies and terms and conditions to make sure they are acceptable to you.

INCLUSIONS: Head Unit, GPS Antenna, Microphone, Wiring Harness, Audio-Video Lead, Plastic Trim & Screws





DISCLAIMER: We recommend using an Authorised Dealer that offers an installation service to install this product. Never cut or modify a harness as this could damage the head unit and vehicle, as well as void the warranty of the product.

FEATURES

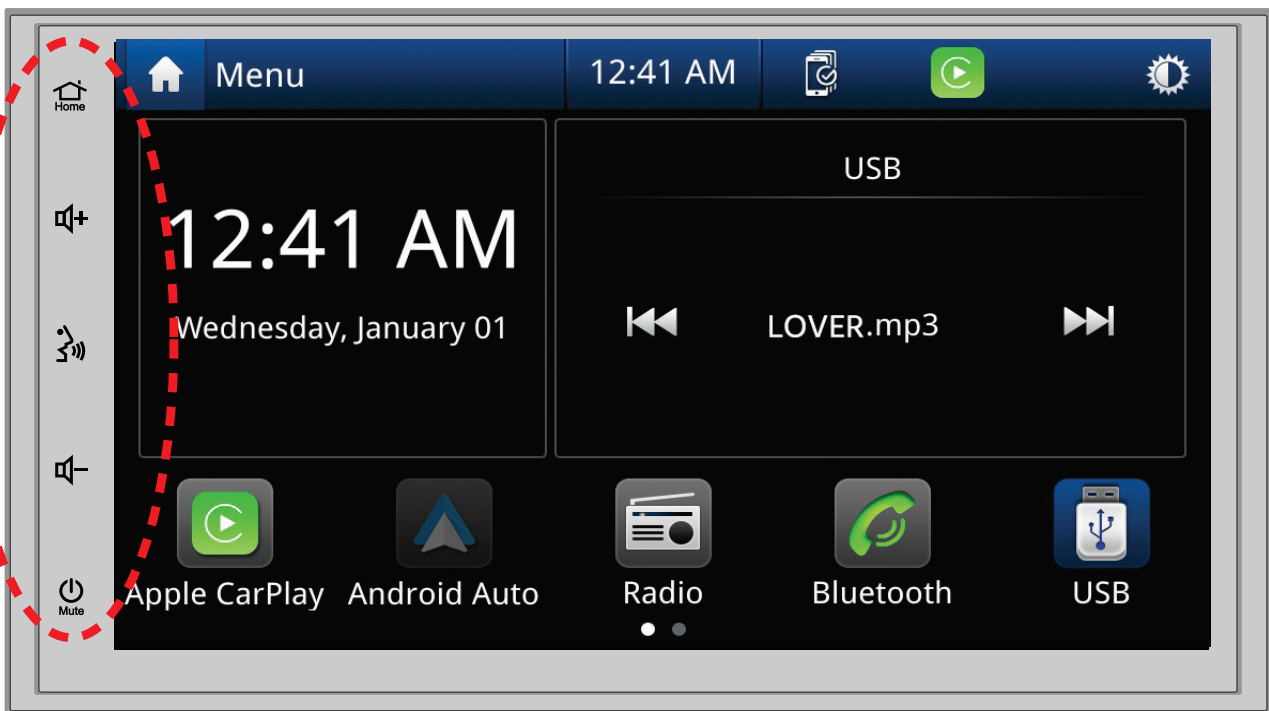
- Large 7" touchscreen LCD (1024 x 600)
- Works with Apple CarPlay (wireless or wired)
- Supports Android Auto (wireless or wired)
- Built-in Bluetooth (A2DP, AVRCP, HFP, PBAP)
- AM / FM Tuner with RDS & presets (18FM/12AM)
- Reverse camera input (AHD 720P compatible)
- Second camera input (AHD 720P compatible)
- Rear A/V input
- 4V / 5CH RCA Preout
- MP3 / AAC / FLAC / MPEG 1,2,4 Media formats
- Subwoofer level control
- Time alignment capabilities
- Dual Rear USB: USB1: CP/AA/USB Media
USB2: USB Media
- 8 Band graphic EQ
- 8 EQ Presets
- 45W x 4 Max built-in amplifier
- Shallow 2-DIN chassis mounting design
- Steering wheel control ready
- External microphone included

INTERFACE ICONS



-  Home
-  Volume Increase
-  Siri / GOOGLE Voice
-  Volume Decrease
-  ON / OFF (Hold)
MUTE (Tap)

MAIN MENU

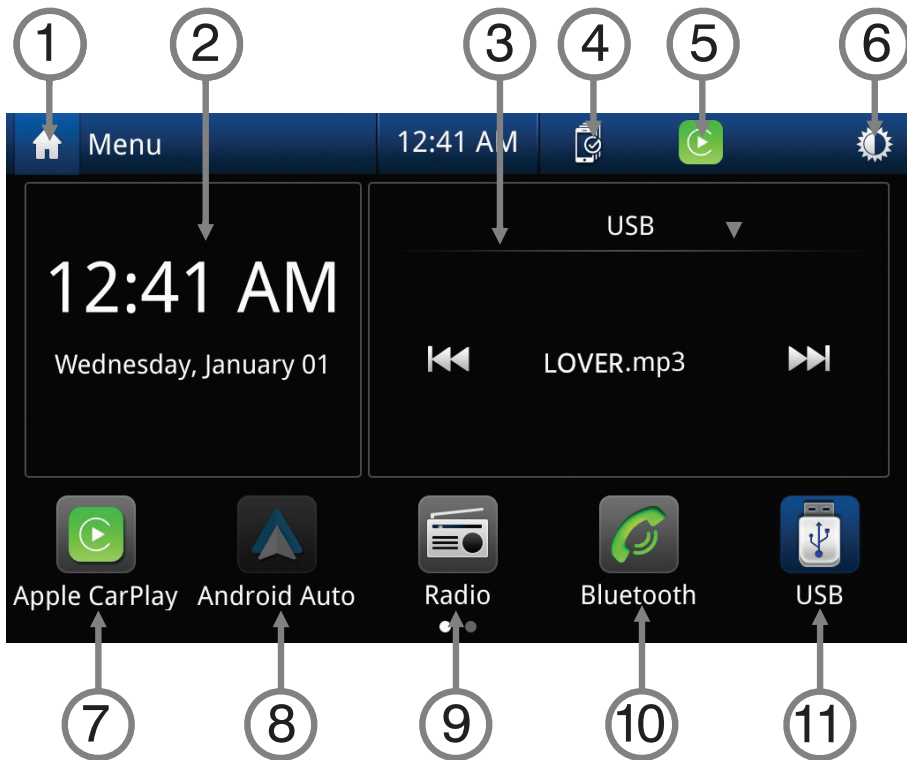

- ① Home screen/back button
- ② Date/Time
- ③ Current Source Music Info
- ④ Connected device (Page 4)
- ⑤ CarPlay/Android Auto mode*
- ⑥ Display On/Off
- ⑦ CarPlay Icon*
- ⑧ Android Auto Icon*
- ⑨ Radio Mode (Page 4)
- ⑩ Bluetooth Mode (Page 6)
- ⑪ USB Mode (Page 5)
- ⑫ AV In
- ⑬ Reverse Camera
- ⑭ Camera 2
- ⑮ Setup (Page 8)

** Icons will only be visible if a compatible mobile device is connected. For more information refer to page 13-14.*



NOTE: The headunit screen will automatically return to its previous source after a period of time, when in the main menu or settings.

CAM R (Reverse camera)

Pressing this icon will trigger and show the reverse camera on the screen if connected.

CAM 2 (Second camera)

Pressing this icon will trigger and show the second camera on the screen if connected.

NOTE: Pressing these icons will send 12v through the Reverse or Cam 2 power wires (p.20) to power the camera. It is not required to have these connected directly to the camera as these icons will still function as long as the cameras are powered.

RADIO MODE

To enter Radio Mode, touch “Radio” icon on the Main Menu



- ① Seek down
- ② Radio frequency
- ③ Seek up
- ④ AF and TA settings
- ⑤ FM Band button
- ⑥ AM Band button
- ⑦ Auto Store button
- ⑧ EQ Mode button
- ⑨ Keypad button
- ⑩ Preset station list

Auto Tuning

Press the seek icon (◀◀ or ▶▶) on the TFT Monitor screen to increase / decrease the tuning frequency one step at 0.05MHz increments for FM and 9KHz increments for AM. Press and hold the seek icon (◀◀ or ▶▶) on the TFT Monitor screen to seek the available channel by increasing or decreasing the tuning frequency.

FM & AM

Touch the “FM1” or “AM1” on the screen to change among the following bands: FM1, FM2, FM3 or AM1 and AM2.

Preset Stations

Six(6) stored stations for the current band appear on the screen, touch the preset directly for use or press the number buttons located on the head unit.

Storing and recalling a Station

1. Select a station. (Example: FM1 103.6MHz)
2. Touch and Hold the desired preset number for 3 seconds to store the Radio station.
3. To recall a station select a Band (If needed).
4. Touch the preset button on which the corresponding radio station is stored or press the number button on the Radio panel.

Setup Button

- **AF** (Alternating Frequency), enables the radio to automatically switch to an alternate frequency broadcasting the same station when the initial signal weakens
- **TA** (Traffic Alert mode), is a feature that interrupts regular broadcast to provide traffic updates and alerts.
- **TP** (Traffic Programme) shows the current radio station supports Traffic Alert Mode.

MEDIA PLAYING MODE

This operation allows you to play various compatible formats.

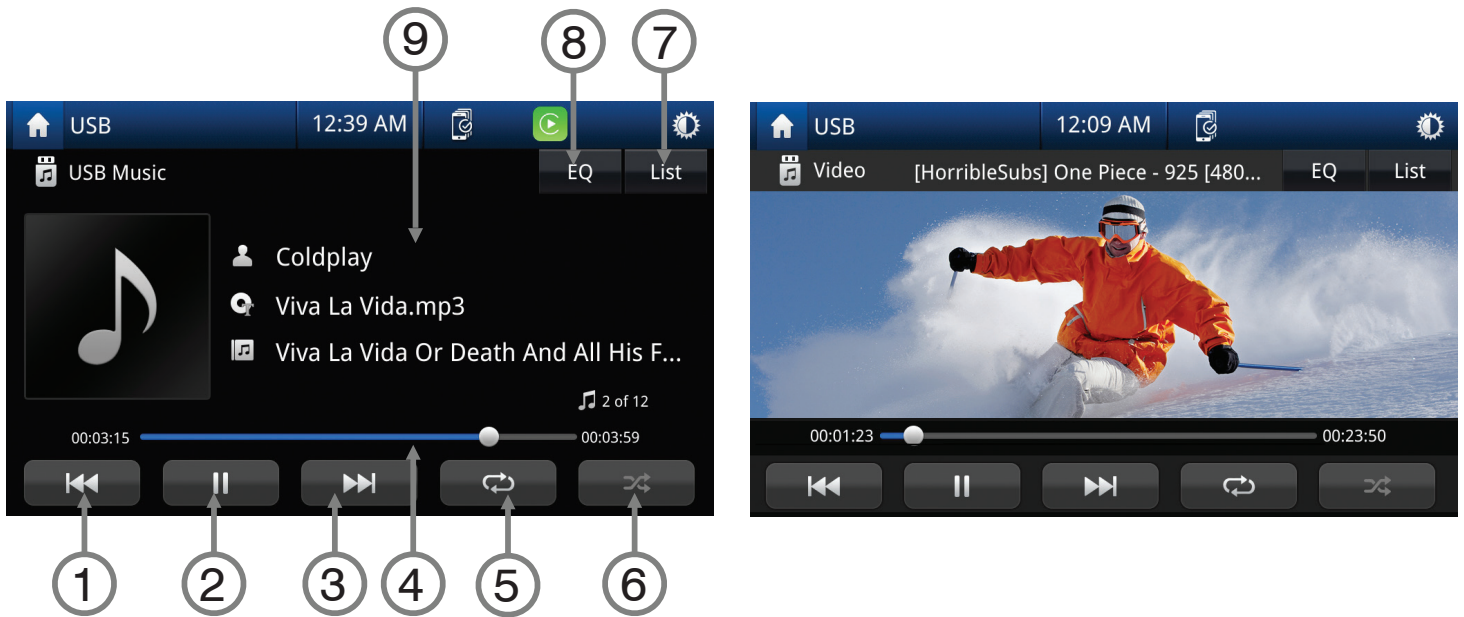

- ① Touch the ◀◀ icon to return to previous track or press and hold the icon to fast rewind
- ② Touch the ▶/|| icon to play or pause the track
- ③ Touch the ▶▶ icon to go to next track or press and hold the icon to fast forward
- ④ Touch the end of the progress bar line and drag it left or right to the desired track time
- ⑤ Touch the icon to repeat a folder or track
- ⑥ Touch the icon to activate / deactivate the track in random mode
- ⑦ Touch the icon to show the track list
- ⑧ Touch the icon to display the equalizer settings
- ⑨ Playing track ID3 info (needs media file support)
- ⑩ Touch to go back to previous folder
- ⑪ Touch for music list
- ⑫ Touch for video list
- ⑬ Touch for keypad for quick search
- ⑭ File List



BLUETOOTH MODE

NOTE: Bluetooth mode can only be accessed when not connected to Android Auto or Apple Carplay. Press  icon to go to connected devices screen.

- When the phone connects to the unit successfully, all of the phone's Bluetooth enabled options will be active.
- This unit can be paired with 5 mobile phones, but only one can be active at a time.
- The unit Bluetooth name is AM7X.

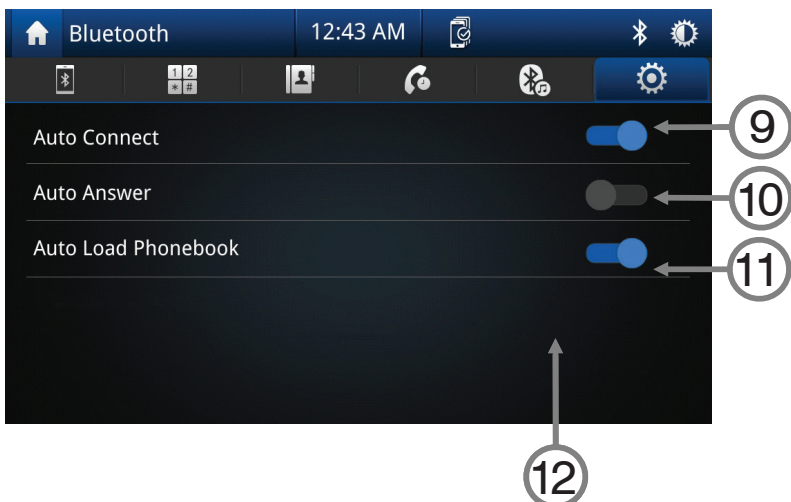
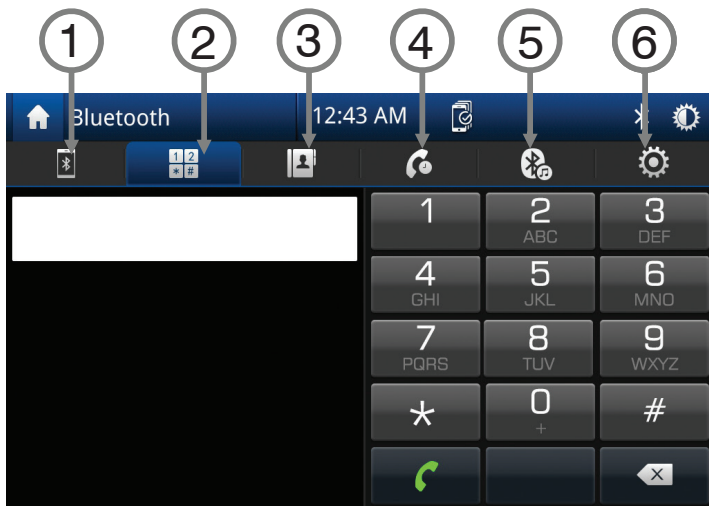

- ① Touch the icon to enter pairing mode
- ② Touch the icon to keypad
- ③ Touch to open the phone book
- ④ Touch to open the phone interface
- ⑤ Touch the icon to enter Bluetooth music
- ⑥ Touch the icon to enter Bluetooth settings
- ⑦ Touch to go to connected device screen
- ⑧ Touch "Refresh" to search for bluetooth devices
- ⑨ Auto connect to your previously paired bluetooth device
- ⑩ Auto answer for incoming calls
- ⑪ Sync Call logs and Contacts
- ⑫ Microphone gain volume control



> Some mobile phones may not support the download function.

> Depending on the music player you are using, streaming may not be supported.

CONNECTED DEVICES SCREEN

Touch the  icon to access the connected devices screen

This screen displays paired devices and allows the user to turn Android Auto/Apple Carplay or other bluetooth features on or off. (If applicable to the device)

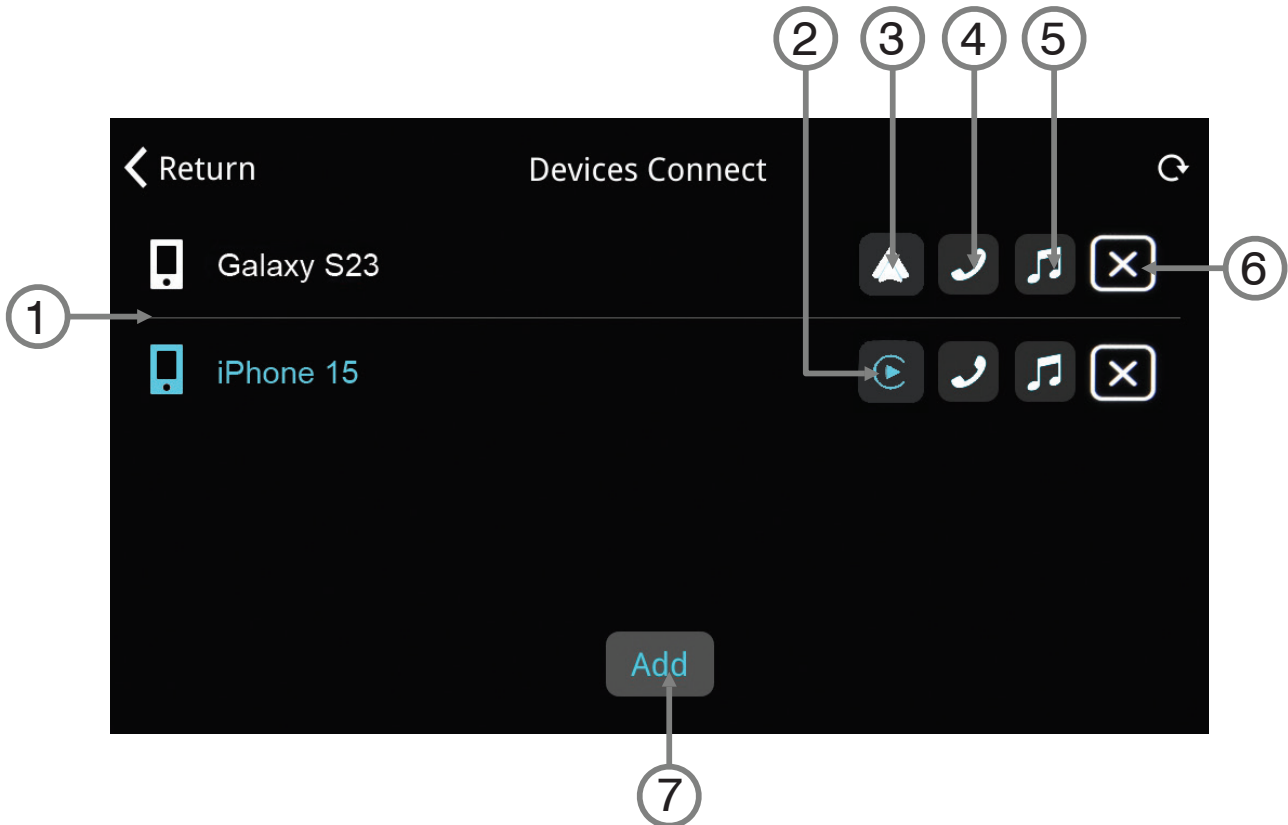

- ① Paired devices
- ② Apple Carplay activate/deactivate
- ③ Android Auto activate/deactivate
- ④ Bluetooth calling activate/deactivate
- ⑤ Bluetooth music activate/deactivate
- ⑥ Remove paired device
- ⑦ Add a new compatible device

NOTE: Only one device can be active at any given time

Bluetooth Calling and Bluetooth Music is deactivated on this screen when using Apple Car Play however Bluetooth Calling and Music work through Apple Car Play as intended.

Android Auto requires Bluetooth Calling and Bluetooth Music to be connected and activated for Android Auto to function correctly.

SETUP MENU

Setup menu allows you to change the settings within unit, General, Display, Audio and Others

General

- Touch “**General**” on the Setup Menu display for general settings

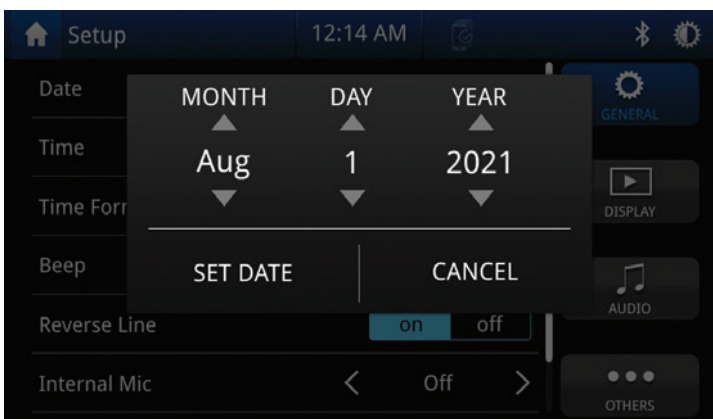
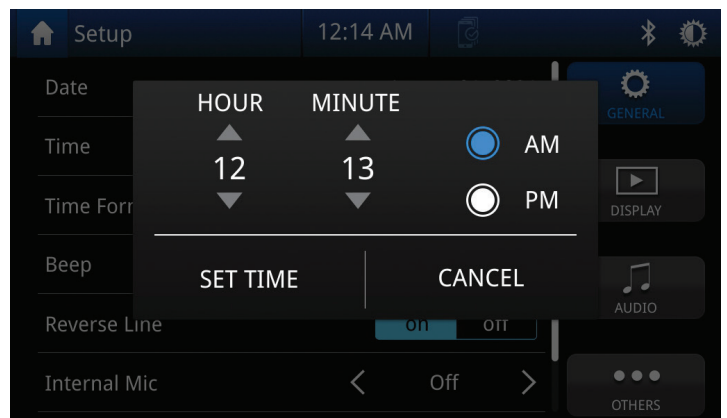
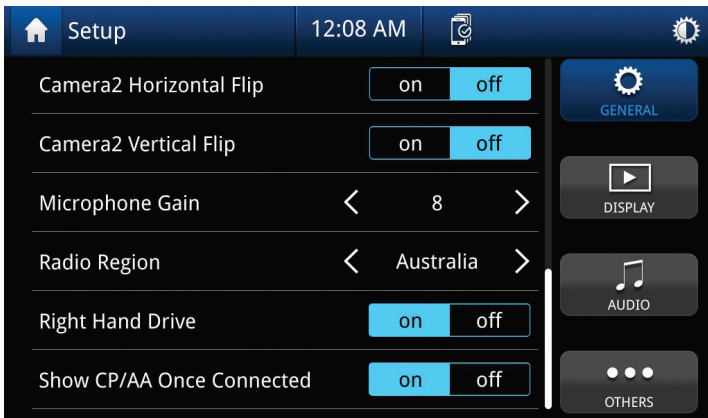
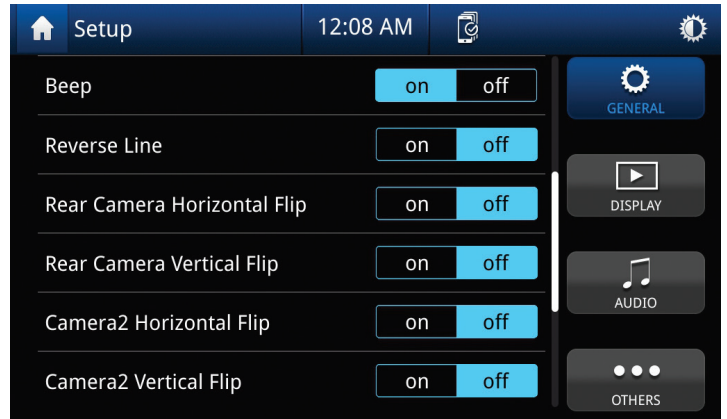
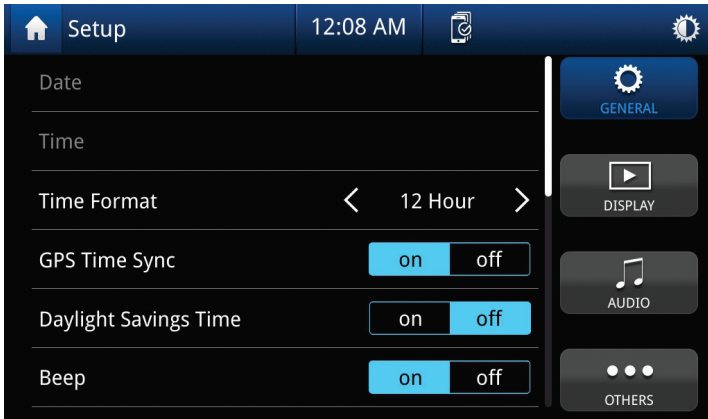

SETUP MENU

Setting	Options	Functions
Date	Day / Month / Year	Select to adjust calendar date
Time	Hour / Minutes	Select to adjust time
Time Format	12 Hour / 24 Hour	Choose clock mode 12H/24H
GPS Time Sync	On / Off	Uses provided GPS module for time and date
Daylight Savings Time	On / Off	Adds +1 hour to clock for daylight savings timezones
Beep	On / Off	Activation / Deactivation of touch screen beep
Reverse Line	On / Off	Adds reversing lines to the reverse camera
Rear Cam Horz Flip	On / Off	Flips rear camera horizontally
Rear Cam Vert Flip	On / Off	Flips rear camera vertically
Camera2 Horz Flip	On / Off	Flips Second camera horizontally
Camera2 Vert Flip	On / Off	Flips Second camera vertically
Microphone Gain	0 to 12	Adjust microphone sensitivity
Radio Region	12 Hour / 24 Hour	Select your radio region
Right hand Drive	On / Off	Changes indicator bar to left or right of display
Show CP/AA Once Connected	On / Off	Will automatically display Android Auto/Apple CarPlay screen when connected

SETUP MENU

Audio

Touch “**Audio**” on the Setup Menu display for audio adjustment settings

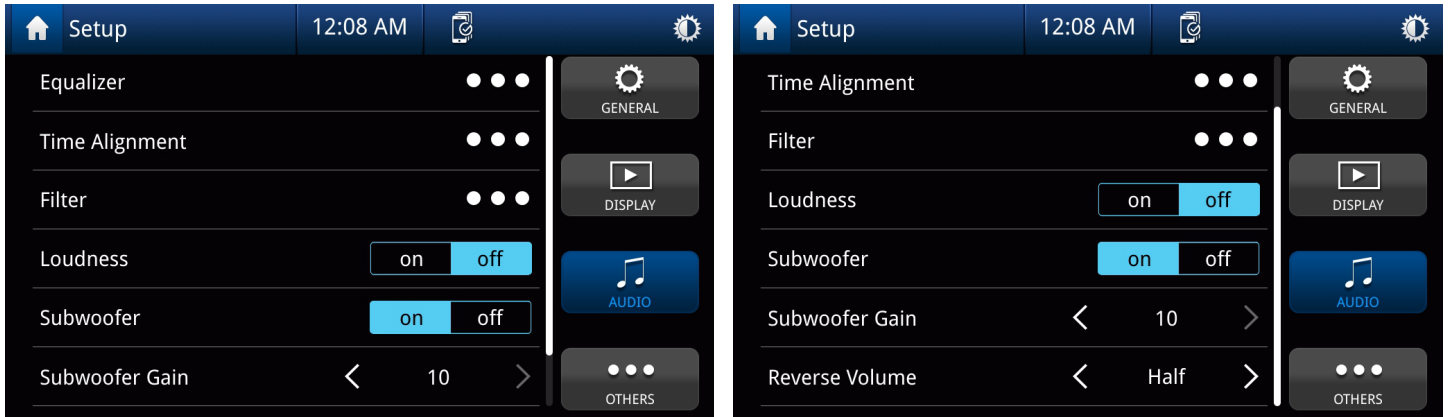

Setting	Options	Functions
Equalizer	-	Balance and EQ setting
Time Alignment	Default / Presets / Reset	Speaker delay
Filter	-	Crossover settings
Loudness	On / Off	Sound boost
Subwoofer	On / Off	Bass switch
Subwoofer Gain	0 to 10	Increase and decrease sub volume
Reverse Volume	On / Off / Half	Controls music volume when reversing

SETUP MENU

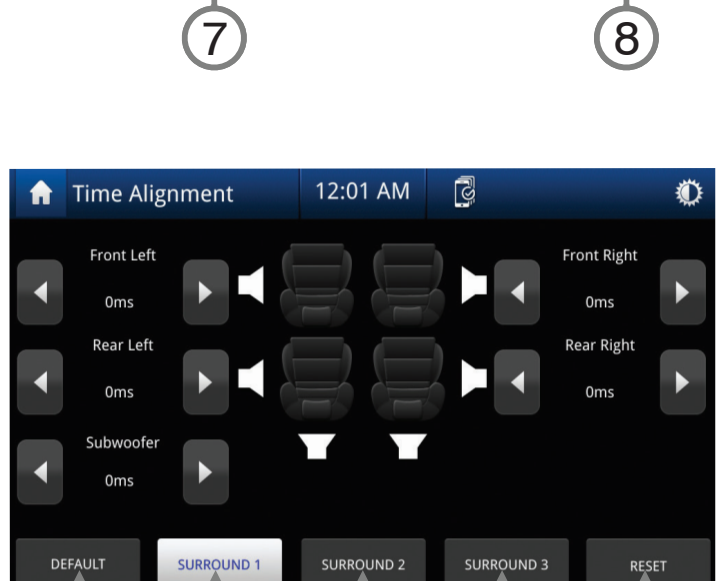
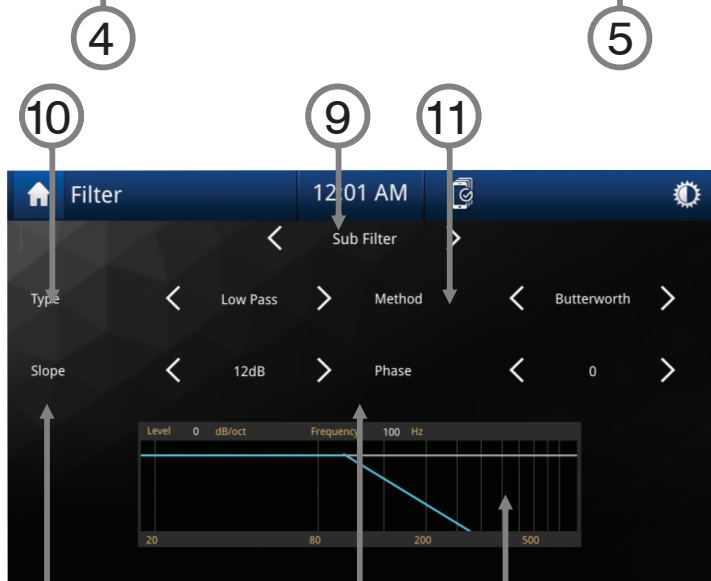
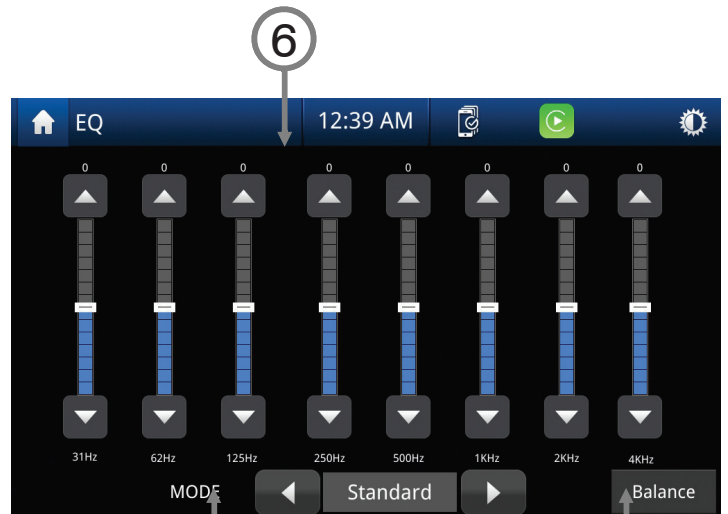
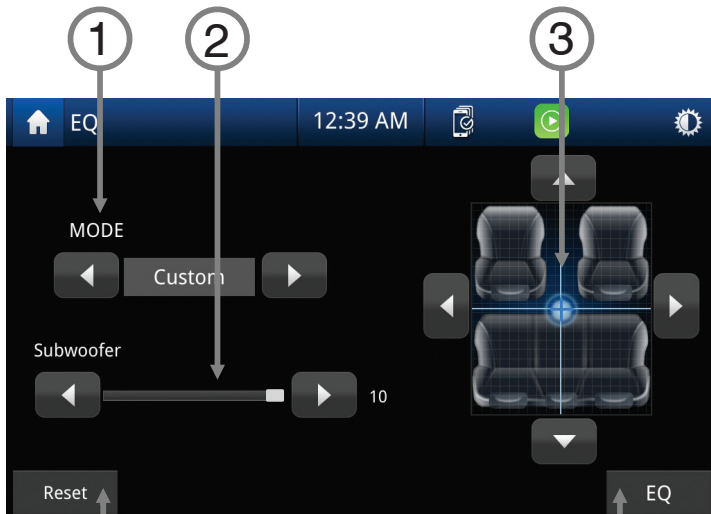

- ① Balance fade presets
- ② Subwoofer volume
- ③ Audio position
- ④ Reset fade parameters
- ⑤ EQ adjustment settings
- ⑥ EQ controls
- ⑦ EQ presets
- ⑧ Balance fade settings
- ⑨ Speaker selection filter (Sub/Front Speakers/Rear speakers)
- ⑩ Crossover type (Low pass/High pass/Through)
- ⑪ Crossover method
- ⑫ Crossover slope
- ⑬ Speaker phase
- ⑭ Crossover frequency adjustment (Tap & Drag to adjust)
- ⑮ Default / No Time alignment
- ⑯ Custom Time alignment
- ⑰ Reset Time alignment settings

SETUP MENU

Display

- Touch “**Display**” on the Setup Menu display, then select a feature you want to adjust.

** Requires an illumination wire to be present in the vehicle (Usually orange wire in ISO harness needs to have a connection)*

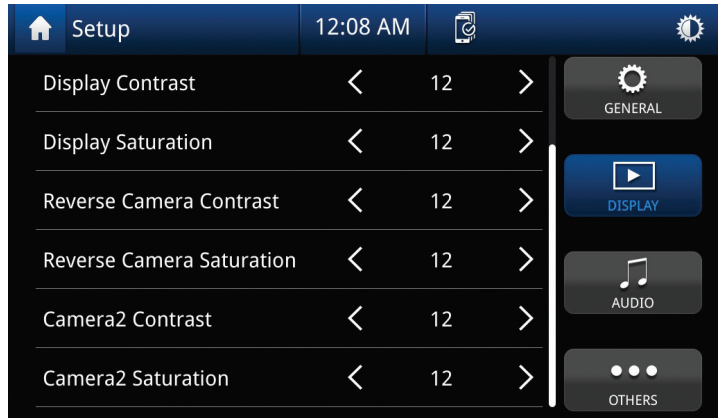
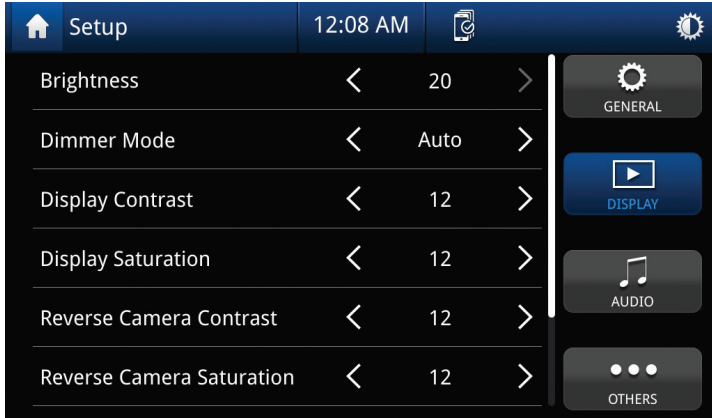

Setting	Options	Functions
Brightness	0 to 20	Touch the desired screen brightness
Dimmer Mode	Auto / Day / Night	Touch the desired screen preset (Auto changes brightness when headlights on*)
Display Contrast	0 to 24	Touch to adjust desired screen contrast
Display Saturation	0 to 24	Touch to adjust desired screen saturation
Reverse Camera Contrast	0 to 24	Touch to adjust desired camera contrast
Reverse Camera Saturation	0 to 24	Touch to adjust desired camera saturation
Camera2 Contrast	0 to 24	Touch to adjust desired camera contrast
Camera2 Saturation	0 to 24	Touch to adjust desired camera saturation

SETUP MENU

Others

- Touch “**Others**” on the Setup Menu display, then select for information and factory reset.

** The Steering Wheel Controls are pre-programmed to suit Aerpro AM7X kits, and is not required to be manually adjusted unless the user wants to customize these functions.*

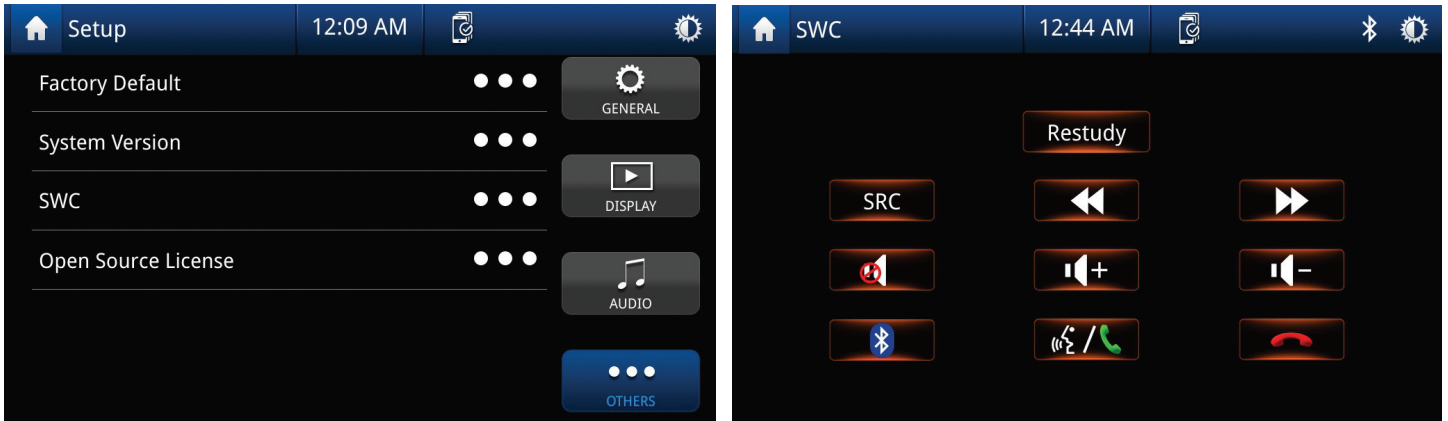

Setting	Options	Functions
Factory Default	No / Yes	Touch to return to the factory setting
System Version	-	Software version of the radio
Steering Wheel Controls	-	Touch to manually adjust SWC functions
Open Source License	-	Displays license information

Steering wheel controls

Connect to the vehicles steering wheel control harness using the steering wheel control cable. Contact your Aerpro dealer for details.

The Steering Wheel Control screen will allow you manually assign your steering wheel controls to control your headunit.

This will only be required if your steering wheel controls are not working correctly.

1. Press Reset to begin the manually setting your Steering Wheel Controls.
2. When the icon is flashing, press the corresponding Steering Wheel Button, matching the icon on the head unit to the steering wheel control. You will know a button is pressed by a string of numbers/letters appearing underneath the button.
3. It will automatically move onto the next icon and wait for the next steering wheel button to be pressed.
4. Repeat this process until you have programmed all your steering wheel controls.
5. If you don't have a corresponding button on your steering wheel, then simply tap the next icon you want to program on the head unit.

NOTE: Not all buttons can be manually set in some vehicles.

SETUP MENU

Others

- When the vehicle is put into reverse, you can tap the screen to display the camera switching icon. Tapping on this icon will switch the view to the second camera.

NOTE: The reverse trigger wire must be connected in order to display the reverse camera when the vehicle is in reverse.

The second camera must be connected in order to use the camera switching function (refer to page 20).



Wired & Wireless CarPlay Operation

NOTE: We recommended that the wired connection method be used for new devices. The park brake needs to be connected for Apple CarPlay to function.

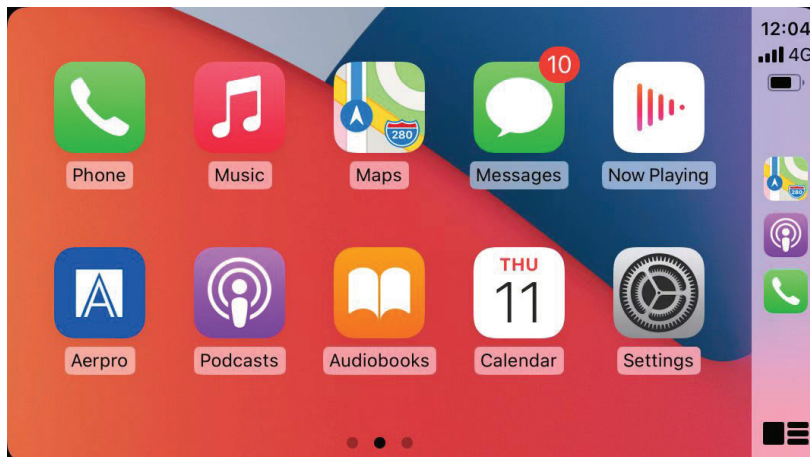

Wired connection

1. Turn on Bluetooth and WiFi on your compatible device
2. Connect an Apple CarPlay compatible device to this unit via USB1 (CP/AA/USB Media)
3. A pair message and a pairing request code may appear on your compatible device and head unit. Click allow to accept
4. An 'Allow CarPlay with Aepro while phone is locked' message may appear on your device. Click allow to accept
5. Click to enable wireless CarPlay or use USB only option
6. Once connection is enabled for wireless carplay, connection via the USB connection is no longer required and wireless connection will be automatic
7. The Apple CarPlay automatically displays on screen, if not press the home button, press  icon and press the Apple CarPlay icon

Wireless connection

1. Before using Apple CarPlay wirelessly, turn on the Bluetooth and WiFi function on the compatible device
2. Navigate to the Bluetooth settings on your compatible device and select AM7X for pairing
3. A pair message and a pairing request code may appear on your compatible device and head unit. Click allow to accept
4. Apple CarPlay automatically displays on screen, if not press the home button, press  icon and press the Apple CarPlay icon

Wired & Wireless Android Auto™ Operation

NOTE: We recommended that the wired connection method be used for new devices. The park brake needs to be connected for Android Auto to function.

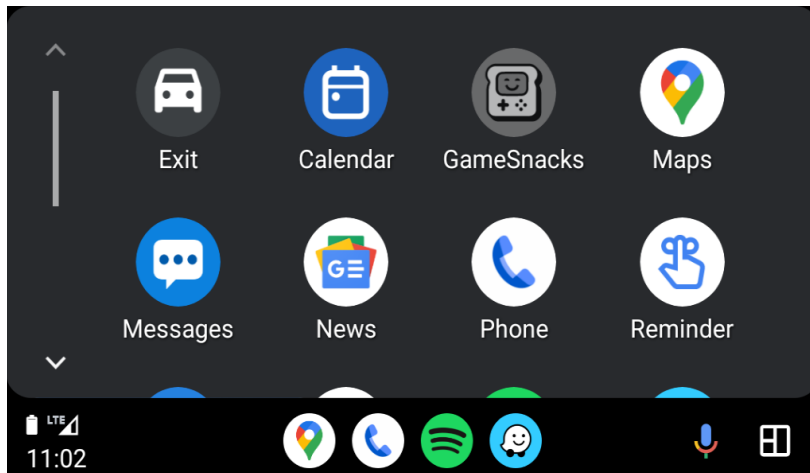

Wired connection

1. Connect an Android Auto™ compatible device to this unit via USB1 (CP/AA/USB Media)
2. Follow on-screen instructions that may appear on your device and head unit
3. Press the Android Auto icon to initiate a connection. The Android Auto home screen appears
4. Once an initial wired connection has been made, connection via the USB connection is no longer required and wireless connection will be automatic.

Wireless connection

1. Before using Android Auto wirelessly, turn on the Bluetooth and WiFi function on the compatible device.
2. Navigate to the Bluetooth settings on your compatible device and select AM7X for pairing
3. A pair message and a pairing request code may appear on your compatible device and head unit. Click allow to accept
4. Android Auto automatically displays on screen, if not press the home button, press  icon and press the Android Auto icon
5. Follow on-screen instructions that may appear on your device and head unit

HOW TO USE CARPLAY®

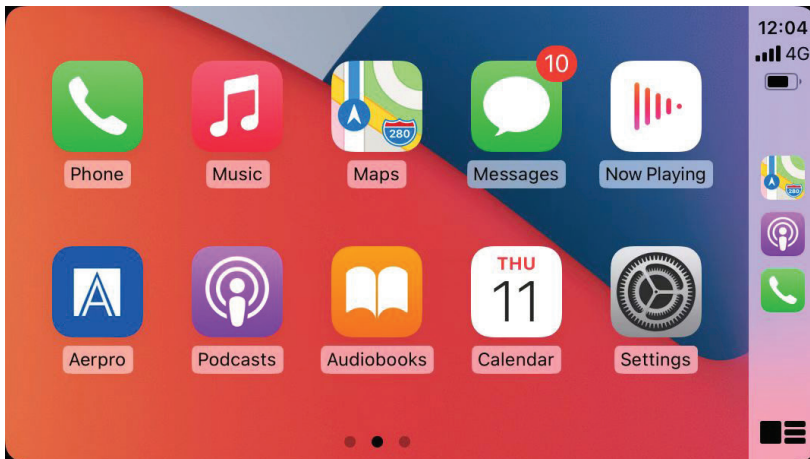

Requirements

- Lightning Data Cable
- iPhone 5 or later
- iPhone with iOS 7.1 or later
- Data Plan for in app content
- Siri activated

Phone Setup (Before you begin):

1. Apple CarPlay® features may operate differently than on your Apple iPhone®
2. Message and data charges may apply when using Apple CarPlay. Please check with your carrier
3. Apple CarPlay® relies on the performance of your phone. If you experience performance issues:
 - Close all apps and then restart them again
 - Disconnect and then reconnect your phone using the Apple Lightning cable that was provided with your phone is recommended.
4. When Apple CarPlay® is active, your voice recognition system is disabled and you will be using Siri® to make your requests
5. On your phone, go to **Settings** > **General** > **Siri** and ensure Siri is turned ON

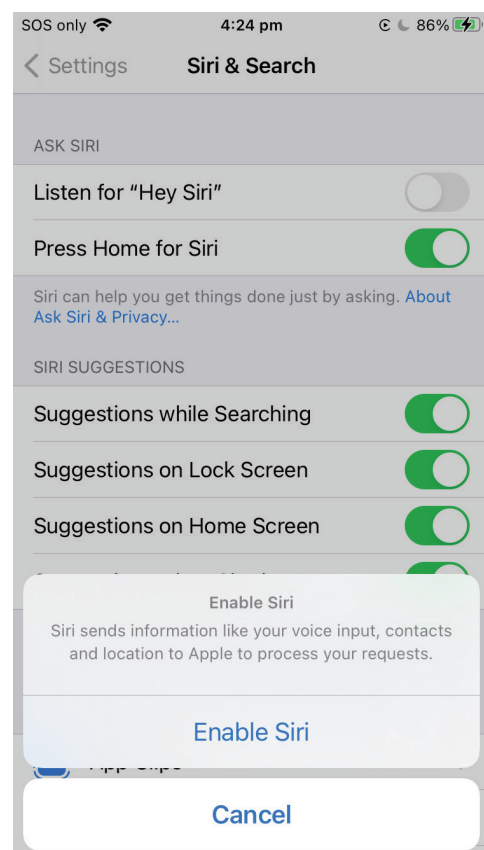
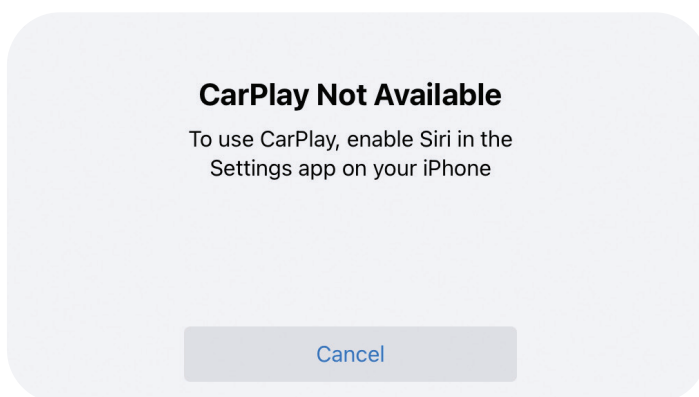

NOTE: For details about Apple CarPlay, refer to the manual supplied with your iPhone, or visit the website of Apple CarPlay.

USING SIRI ®



Voice button

NOTE:

Ensure Siri feature is set to ON in your phone (**Go to Settings > General > Siri**).

Apple CarPlay uses Siri to perform many actions like sending messages, placing calls, and looking up/setting POI/Destinations. A Siri session can be initiated on any screen by:

- Touching and holding the Home icon on the CarPlay screen or
- Pressing the Voice button on the panel or the Steering Wheel, then say any of the following commands:
 - **“Text <Name> Call you later”** to send a text message.
 - **“Read text messages”** to read available text message.
 - **“Call <Name>”** to make a phone call.
 - **“Find <POI/Destination>”** to locate a POI/Destination.

USING GOOGLE VOICE ®

Android Auto uses Google voice actions for many functions. A Google voice action session can be initiated on any screen by:

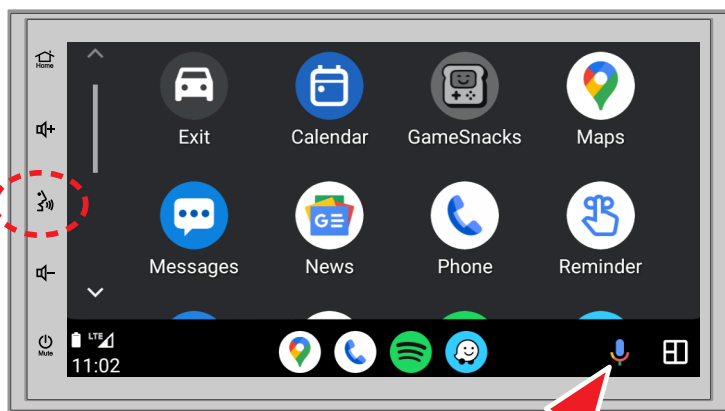

Making a Call

Touch the Phone icon to access recent call list. Or you can initiate a voice action and then say **“Call <Name>”** or **“Dial <number>”** to make phone calls from any screen.



Voice button

- Touching the **Microphone** icon on any screen.
- Pressing the **Voice Recognition** Button on panel or Steering Wheel.

HOW TO USE ANDROID AUTO ®

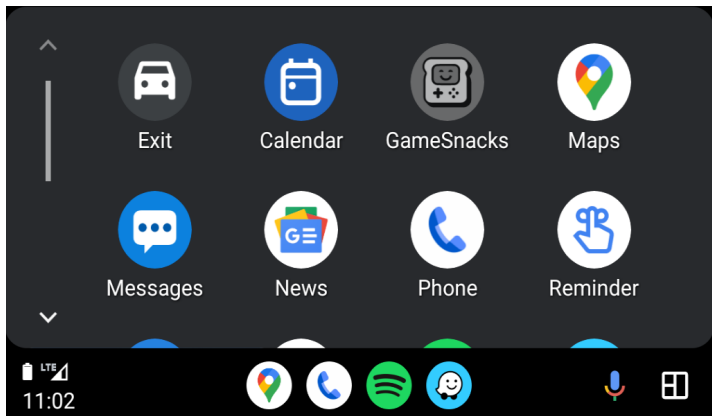

Requirements

- A high-quality USB cable
- Compatible Android® phone with OS Android 8.0 or higher
- Data Plan for in app content
- Wireless Android Auto requires 5GHz(802.11/ac) Wi-Fi support (refer to page 18 of this manual)
- Android Auto App download from the Google Play® store if not on your device
- Android Auto must be available in your country or region

Phone Setup (Before you begin):

1. Android Auto ® features may operate differently than on your Android ® phone.
2. Message and data charges may apply when using Android Auto. Please check with your carrier
3. Android Auto relies on the performance of your phone. If you experience performance issues:

Close all apps and then restart them again

Disconnect and then reconnect your phone using the USB cable that was provided with your phone is recommended

When Android Auto is active, your in-vehicle voice recognition system is disabled and you will be using Google® voice actions to make your requests

Overview

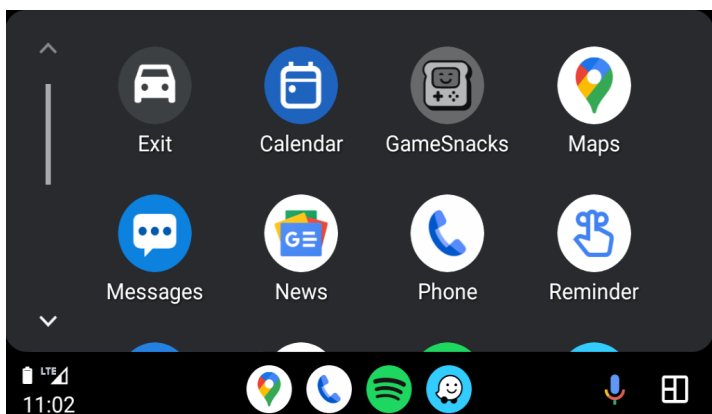

- Android Auto organizes recent actions and information into simple icons on the Android Auto Home screen. Touching an actionable icon will take you to the app.

NOTE: For details about Android Auto, refer to the manual supplied with your Android phone, or visit the website of Android Auto.

GENERAL WIRING DIAGRAM

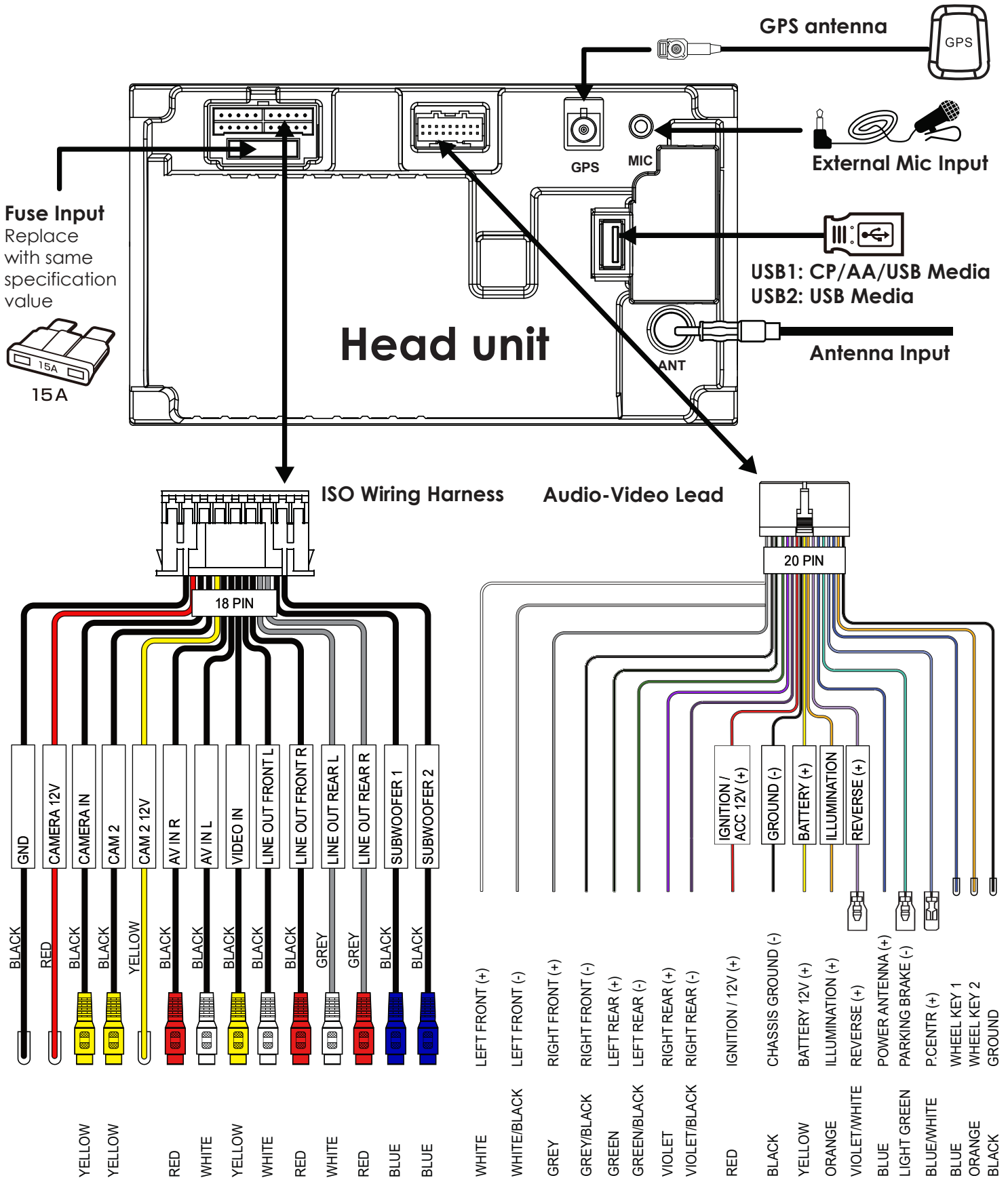

NOTE: This diagram shows a basic wiring configuration. For your safety be sure to connect the park brake wire. Some vehicles will not have a park brake output from the vehicle.

SPECIFICATIONS

Display LCD	Size	7" (7X)
	Resolution	1024*600
Touch Screen	Capacitive	G+G
System Specification	OS System/CPU	Linux 3.4.5 / SPHE8368U
	RAM / Flash Memory	128MB / 256MB
DIN Size	2.0 DIN	2DIN short body
Power Output	Rated Power	4CH x 25W
	MAX Power (4 Ohm @ 14.4 V, 1 kHz, THD 10 %)	4CH x 45W
Media Playback	MP3 / MP4 / AAC / FLAC / Xvid	Yes
Device Ports (Rear)	USB1: 5V / 1.5A	CP/AA/USB Media
	USB2: 5V / 1.5A	USB Media
	USB MAX Capability	FAT32_32GB
Aux Inputs / Outputs	Rear A/V Input (RCA Type - 3pcs)	Yes
	Reverse Camera Inputs	Yes (720P AHD Compatible)
	Second Camera Inputs	Yes (720P AHD Compatible)
Mirror Link	CarPlay & Android Auto	Wireless and Wired
Bluetooth	Bluetooth Built-In	Yes(A2DP, AVRCP, HFP, PBAP)
	Bluetooth Version	V4.2+EDR
	Microphone	External Microphone
	ID3 Tag/Information (Artist, Album, Song)	Yes
	HFP Profile (1.2, 1.4 or HD Voice 1.6)	HFP 1.6
Tuners	AM/FM (# of Presets)	AM 12 (6X2) / FM 18 (6X3)
	FM Frequency Span (MHz)	87.5-108.0MHz (0.05MHz Step)
	AM Frequency Span (KHz)	531-1629KHz (9KHz Step)
	RDS	Yes
	FM Antenna Connector Impedance	50 Ohm
	FM Tuner Connector	Motorola
RCA Preamp Outputs	2-Pair RCA Preamp Output	Yes
	Subwoofer RCA Output/Level Control	Yes
	Preamp Voltage (1.2,2,4,5,6)	4V p-p
Tone Control	8 Band	(50/200/400/800/1K/3K/7K/15K)
	Loudness	Yes
	LPF - Frequencies (Sub)	Yes
	8 Preset EQs	Yes
Other Features	Steering Wheel Control	Yes, with with 3 wires
Accessories	Power Harness	Yes with ISO
	AV-In Cable (RCA with Audio L/R, Video In)	Yes
	Reverse Camera Input	Yes
	4.2CH Audio Out Cable	Yes
	External Microphone	Included

My Android phone will not connect wirelessly to the head unit

- Your mobile phone must be a compatible Android phone with an active data plan, 5 GHz Wi-Fi support (802.11/ac), and the latest version of the Android Auto app.
- Compatible Android phones include:
 - Any phone with Android 11.0 or above
 - A Google or Samsung phone with Android 10.0 or above
 - A Samsung Galaxy S8, Galaxy S8+, or Note 8, with Android 9.0 or above
- If your phone does not meet the compatible Android phone list but has 5 GHz Wi-Fi support, you can follow these steps. (Note: We cannot guarantee this will provide a reliable Wireless Android Auto experience and is used as a work around for older phones)
 - Go to the settings of the Android Auto app
 - Scroll down to the bottom where it states version number
 - Tap this several times until a pop up message appears asking to enable Developer options. Accept this message
 - Tap on the 3 dots in the top right corner and choose Developer Settings
 - Scroll down until you can find 'Add wireless projection to settings' and enable this. (Make sure that it is also ticked in the settings of Android Auto under 'Wireless projection' section.)
 - Try the connection process again

If you are still having issues connecting your Android phone wirelessly to the head unit, try the steps below

- Navigate to your Android Settings
- Scroll and tap on the 'Apps' Settings
- Tap on 'Android Auto'
- Scroll to 'Storage' & tap on it
- Clear Cache first on the right side
- Then 'Clear Data'
- Press 'Delete' on the pop-up message
- Turn off Wi-Fi
- Navigate to your Bluetooth Settings
- Tap the Cog on the previously paired Aerpro head units Bluetooth. If you have not previously paired with the head unit, you can skip to re-pairing your phone with the Aerpro head unit.
- Tap Unpair.
- Now you can begin pairing with your Aerpro Headunit and follow the steps from the pairing procedure in the manual.

If you are still having issues, try restarting your phone and going through this process again.

You can watch a visual process of these steps by visiting the product page on the Aerpro website, or click on the URL link below:

<https://youtu.be/DU7cfw4hfNI>

My Mobile phone will not connect to the head unit

- If you are having trouble connecting your phone to the head unit, try restarting your phone and try again.
- It is also recommended to do a factory reset on the head unit as this will solve most of the connection issues between your phone and your head unit.
- If you are having issues with connecting Android Auto or Apple CarPlay over a USB connection, try using another high quality/shorter length cable. Using low quality cables and longer lengths may cause issues such as drop outs and or connection issues.
- Make sure your phone is up to date with the latest software updates.

Do I have to connect the GPS module for Android Auto/Apple CarPlay to work?

- It is highly recommended to connect the GPS module to the head unit and place it where it has a clear line of sight to the sky as it will assist the GPS tracking for maps when using Android Auto or Apple CarPlay.
- If you do not use the GPS module then the GPS tracking will rely purely on your phone's tracking performance which may be spotty depending on the location of the phone in the vehicle.

Red Blinking Power Light on the Head Unit

- This can mean the head unit doesn't have enough power to power on the unit or there is a wiring issue. Please refer to the aerpro website for specific instructions related to your vehicle.

Android Auto/Apple CarPlay won't work unless Park Brake is active but the kit didn't have a Park Brake connection.

- If the harness that came with your kit didn't have a park brake connector then you must manually make a connection between your hand brake and the harness on the headunit for these functions to work.

Issue with microphone on handsfree calls

- Try increase or decreasing the gain in the settings menu (see p.8)
- Ensure that the microphone is connected to the back of the headunit.
- Make sure to use the external microphone provided with this product as other external microphones may be incompatible.

SAFETY INFORMATION & WARNINGS

Do not try opening the shell or try to repair the product by yourself.

If the product or it's accessories have any problems and is still under warranty, then take it back to the place of purchase with the original purchase receipt.

If out of warranty then contact the authorised repair agent, Aerpro Support.

Do not use a chemical substance, cleaning solvent or cleaner to clean the product, please use a moist soft cloth if you would like to clean the product.

Do not use the product under conditions where dust is present.

Please pay attention to cleaning the display surface, use a moist soft cloth to clean the display.

TECHNICAL ASSISTANCE

Please retain this user guide for future reference.

If you would like to download a digital copy of this manual, or other Aerpro manuals/software, please visit the Aerpro.com website and search for information on your model.

This quick start guide is considered correct at time of printing but is subject to change.

For latest quick start guide, manuals, videos and updates refer to the website.

Copyright © 2024 by TDJ Australia

All rights reserved. No part of this publication may be reproduced, distributed, or transmitted in any form or by any means, including photocopying, recording, copying or other electronic or mechanical methods, without the prior written permission of the author.

TEL: 03 – 8587 8898 FAX: 03 – 8587 8866

Mon-Fri 9am – 5pm AEST

aerpro.com

