



10" ADVANCED INFOTAINMENT SYSTEM

INTEGRATED HEAD UNIT UPGRADE

to suit **TOYOTA LANDCRUISER 200 SERIES VX/SAHARA 2016-2021**



AMUTO53

INSTALLATION MANUAL

to suit **TOYOTA LANDCRUISER**
200 SERIES VX/SAHARA
2016-2021

Factory Features Unable To Be Retained

- **VFD Clock (Fig. 1)** - Clock relocated to aftermarket head unit home screen.
- **Climate Shortcut Button (Fig. 3)** - Factory button was not retained so a Climate button on the aftermarket head unit was added.
- **DVD Player & Associated Buttons/Dials (Fig. 2 & 4)** - Has no function and will not be able to play DVDs or adjust volume with the dials.
- **Audio Control from Head Unit to Rear Entertainment Screens** - Rear entertainment system can still be used standalone using the rear HDMI/AV ports (Refer to Manual FAQ for more information).
- **Auxiliary jack next to USB port** - Is not retained.
- **Audio source control from MFD** - Cannot change audio source of headunit using the MFD.
- **Vehicle maintenance setting** - Previously accessed from factory screen.



Attention: Vehicles without 360 camera (Reverse Camera Models).

Your factory reverse camera is required to be upgraded using the supplied AHD 720p reverse camera. Please refer to the manual for more information.

This kit has not been configured to retain the original reverse camera as it is low resolution. Upgrading the camera is necessary to retain the reverse camera function.

In order to retain the factory amplifier, please ensure that you connect the **MOST** connector (Refer to Manual) and insert the white RCA plug labelled **(Stereo)** into the back of the head unit next to the blue connector. Please ensure that only the 59 pin plug is connected to the back of the original climate control system, if not, you may be presented with no audio. Please visit the manual for more information.



There is an adhesive label on the back of the headunit stating to refer to the manual for more information. For the Australian region, the 360 camera plug is white or black and not blue. If your vehicle has a 360 camera connector like **Fig. 1** you can plug the white connector straight into the back of the head unit. If your 360 camera vehicle connector, like **Fig. 2**, then you will need to use the included 360 camera adaptor to convert the 360 plug, and then connect it to the back of the head unit. Do not pair Blue with Blue. If the head unit is not displaying the 360 camera then ensure that the correct vehicle connector is plugged into the blue port of the head unit and that the **'R Camera In'** RCA from the main harness is also plugged into the **'R Camera'** of the AV Harness on the head unit **Fig. 3**.

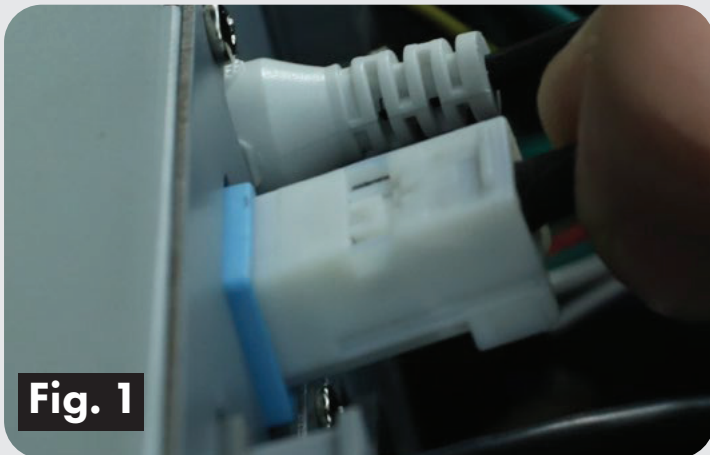

CONTENTS

Tools required.....	2
Product overview.....	2
Inclusions.....	2
Pre-installation checks.....	2
Connection wiring diagram.....	3
Wiring diagram.....	4
Dash disassembly.....	5
Head unit assembly.....	17
Wiring.....	19
Dash reassembly.....	29
Testing the new unit.....	35
Technical assistance.....	36
Brand information.....	36

Tools required

Use the following tools to make dismantling the dash and the installation of the new kit easier.
NOTE: Do not use power tools, only use the tools recommended below, and do not over tighten screws as they may damage other components. Also take care in removing trim panels as over time they may have become brittle.

1. Plastic panel remover (pry tool)



2. Phillips Head Screwdriver

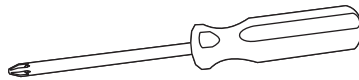

3. 10mm socket, extension, and ratchet

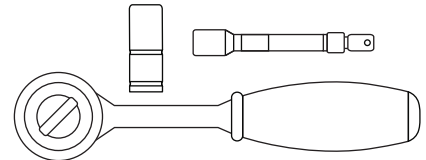

Product overview

The Aerpro AMUTO53 is a head unit replacement kit to suit the Toyota Landcruiser 200 Series Sahara & VX* (*VX only from 2016-2021) models. These kits are Australian designed and engineered to replace the original Toyota head unit and retain the vehicles original functions* while adding features such as Apple CarPlay, Android Auto, larger 10.1" High Definition display, Dual USB input, and an additional High Definition camera input.

Inclusions

- Infotainment unit
- Infotainment monitor with physical buttons
- Mounting brackets and screws
- Power harness
- LVDS cable
- MOST / GPS / DAB / USB / 360 retention harnesses
- Audio visual lead
- 720p AHD Surface Mount Camera

Pre-installation checks

Prior to disassembling the dash and removing the original head unit perform the following checks to determine their functionality:

- | | |
|---|--|
| <input type="checkbox"/> Steering wheel controls | <input type="checkbox"/> Factory vehicle settings |
| <input type="checkbox"/> 360 degree camera | <input type="checkbox"/> Bluetooth microphone |
| <input type="checkbox"/> Parking sensors front / rear | <input type="checkbox"/> Audio output and adjustment |
| <input type="checkbox"/> Climate controls | <input type="checkbox"/> AM / FM / DAB |
| <input type="checkbox"/> Hazard light switch | <input type="checkbox"/> USB port |

Connection wiring diagram

- 1 LVDS Monitor
- 2 Segment Display & Buttons
- 3 MOST Connector
- 4 Factory 360 Camera
- 5 MOST Stereo Connector
- 6 Multiplex Connector
- 7 AM/FM Antenna Plug
- 8 GPS Antenna Plug
- 9 USB 1: CP/AA
- 10 USB 2: Media
- 11 AV Harness
- 12 DAB Antenna Plug
- 13 Multiplex Harness
- 14 Hazard Connector
- 15 360 Camera RCA
- 16 AM/FM Antenna Adaptor
- 17 Microphone
- 18 360 Camera Adaptor (*To be connected to No.4 pictured below depending on vehicle. See P. 25*)

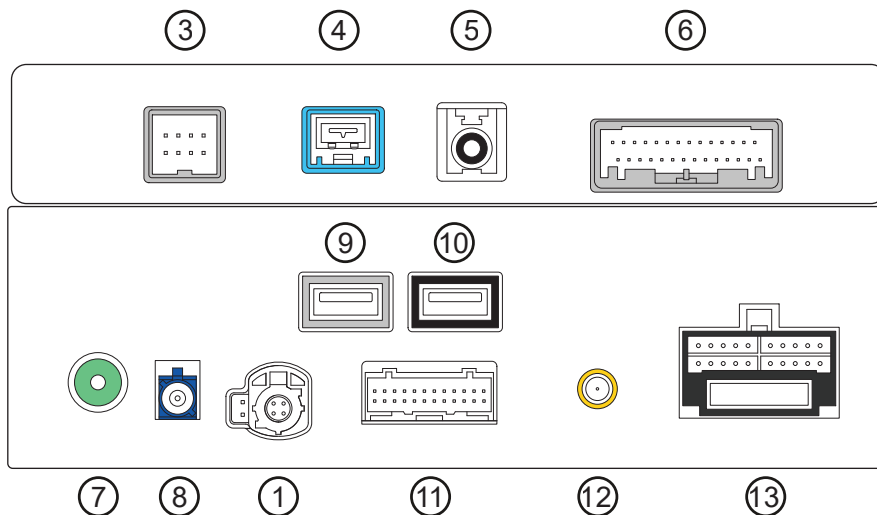
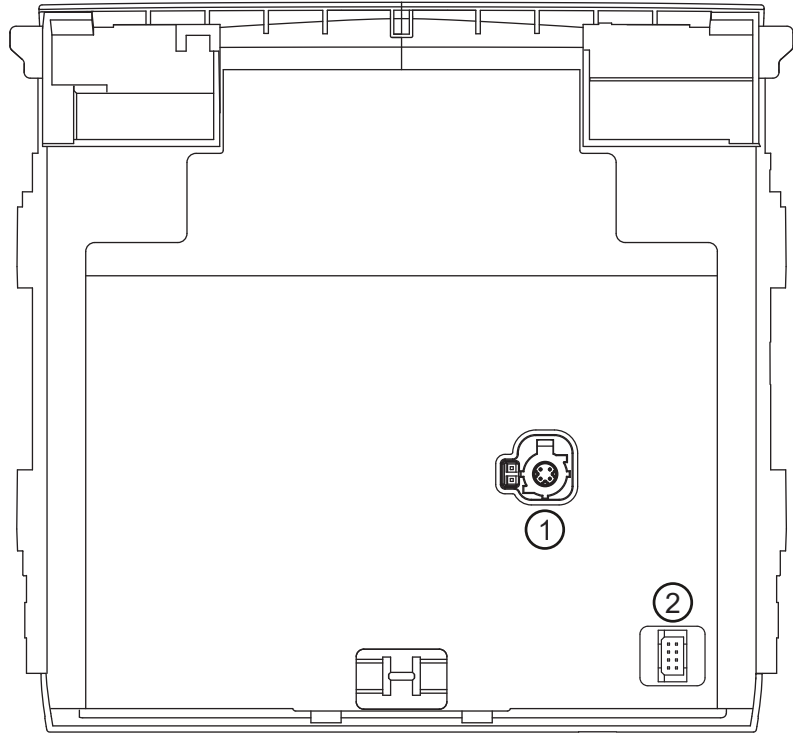

NOTE: Numbered Plugs are mandatory for head unit to function correctly

Wiring diagram

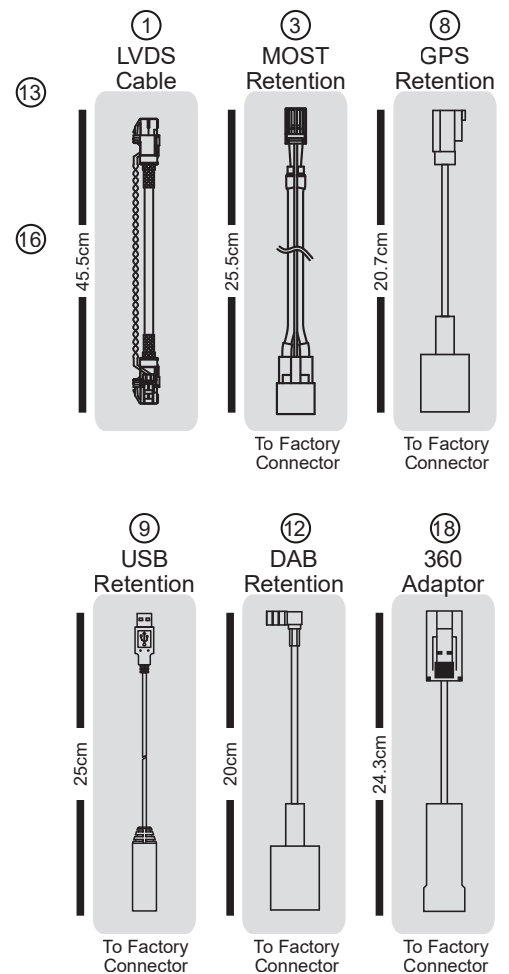
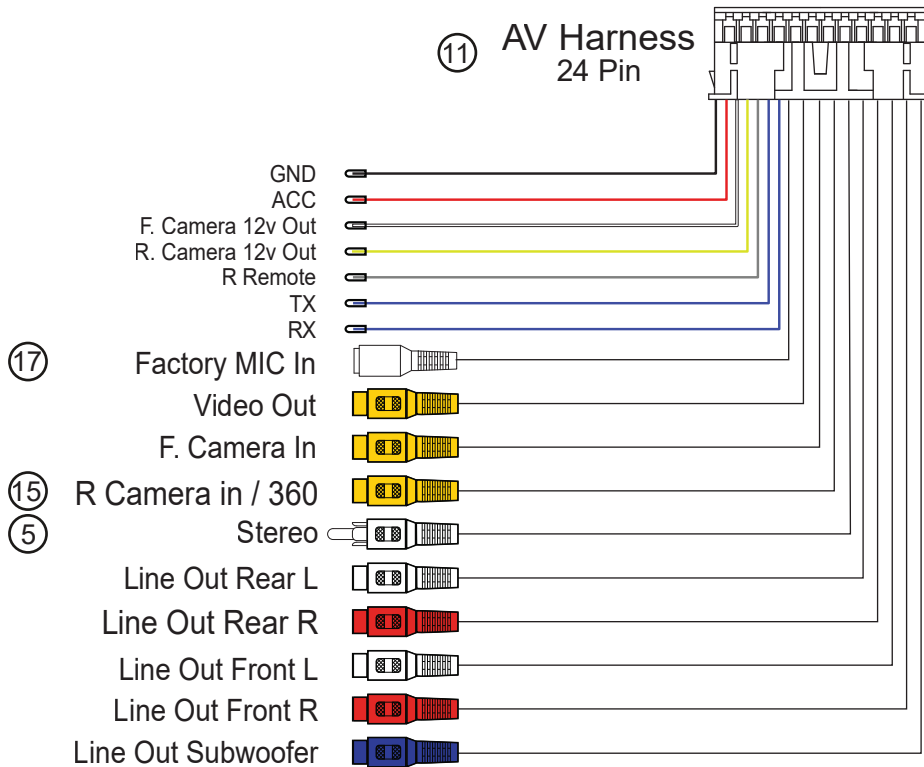
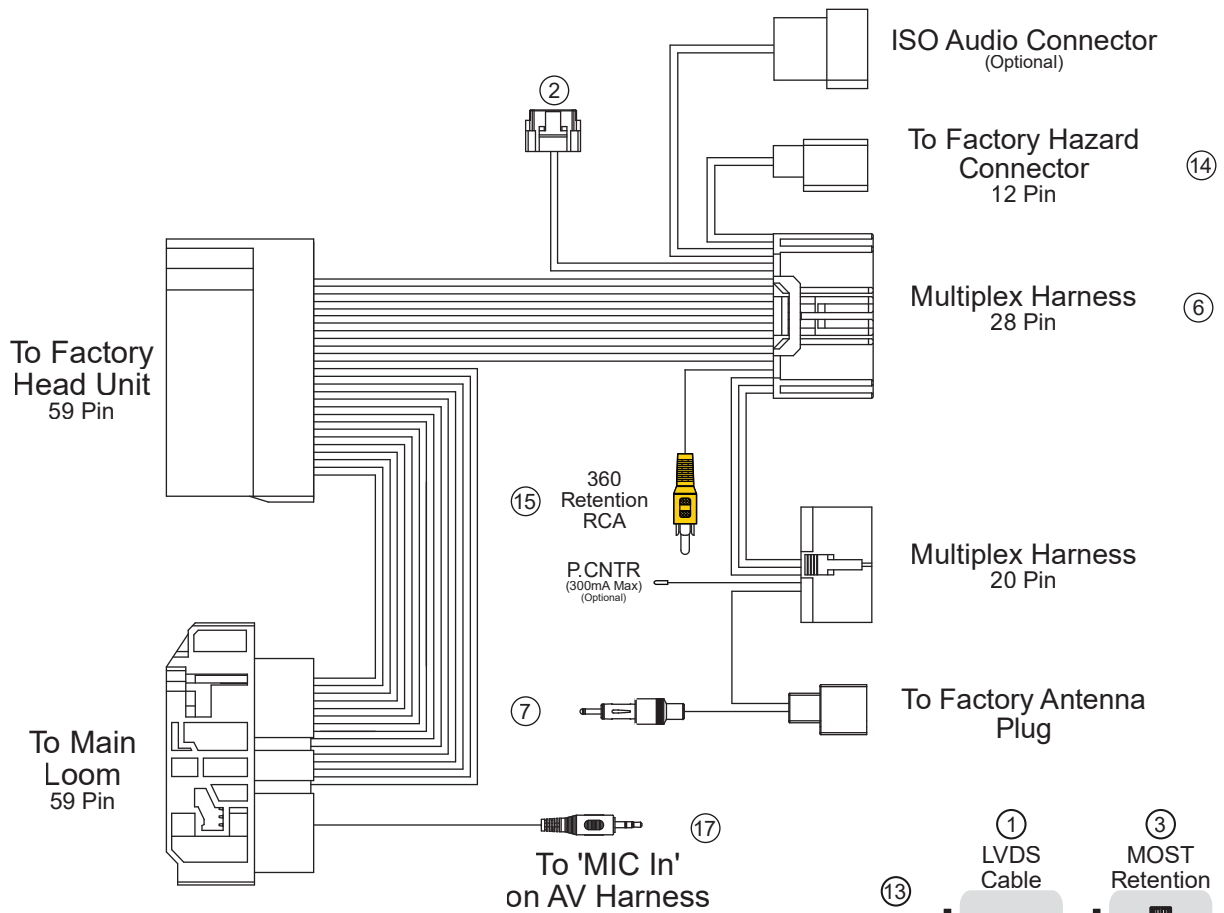

Dash disassembly

Remove the panel which is located by the left knee of the driver by pulling it firmly toward yourself. Place this panel aside.



Remove the 10mm bolt indicated in figure 1.



Dash disassembly cont.....

Remove the panel with the engine start / stop button by pulling it firmly on an angle toward yourself as indicated in figure 2.



Disconnect the harness leading to the engine start / stop button. Place this panel aside.



Dash disassembly cont.....

Repeat the process on the opposite side, remove the panel located by the right knee of the passenger by pulling it firmly toward yourself. Place this panel aside.



Remove the 10mm bolt as per previous side.



Dash disassembly cont.....

Remove the panel indicated in figure 3 as per the previous side. Place this panel aside.



Using either the physical key of the vehicle or a flat head screw driver, remove the cover over the transmission levers shift lock.



Dash disassembly cont.....

Once the shift lock cover has been removed, using either the physical key or a flat head screw driver, press the shift lock button down to allow you to move the transmission lever down to the Drive position, out of the way.



Remove the storage compartment panel below the stereo controls by pulling firmly toward the rear of the vehicle (You may require the connected harnesses to be disconnected to have this panel completely removed). Place this panel aside.



Dash disassembly cont.....

Remove the air vents from both sides by gently using a plastic pry tool around the edges to detach them from the dash. Place them both aside.



Dash disassembly cont.....

Remove the grille at the top of the dash by gently using a plastic pry tool along the front edge and both sides to release the clips. Once lifted out of its place, disconnect the light sensor harness attached to it. Place this panel aside.



Dash disassembly cont.....

Remove the 2x 10mm bolts from under the grille at the top of the dash indicated in figure 4 and place them aside.



Remove the 2x 10mm bolts from behind the air vents either side of the stereo indicated in figure 5/6 and place them aside.



Dash disassembly cont.....

Remove the original screen by pulling it firmly toward the rear of the vehicle. Once the clips have been released it can be flipped up to allow the 4x harnesses to be disconnected. This panel will no longer be required.

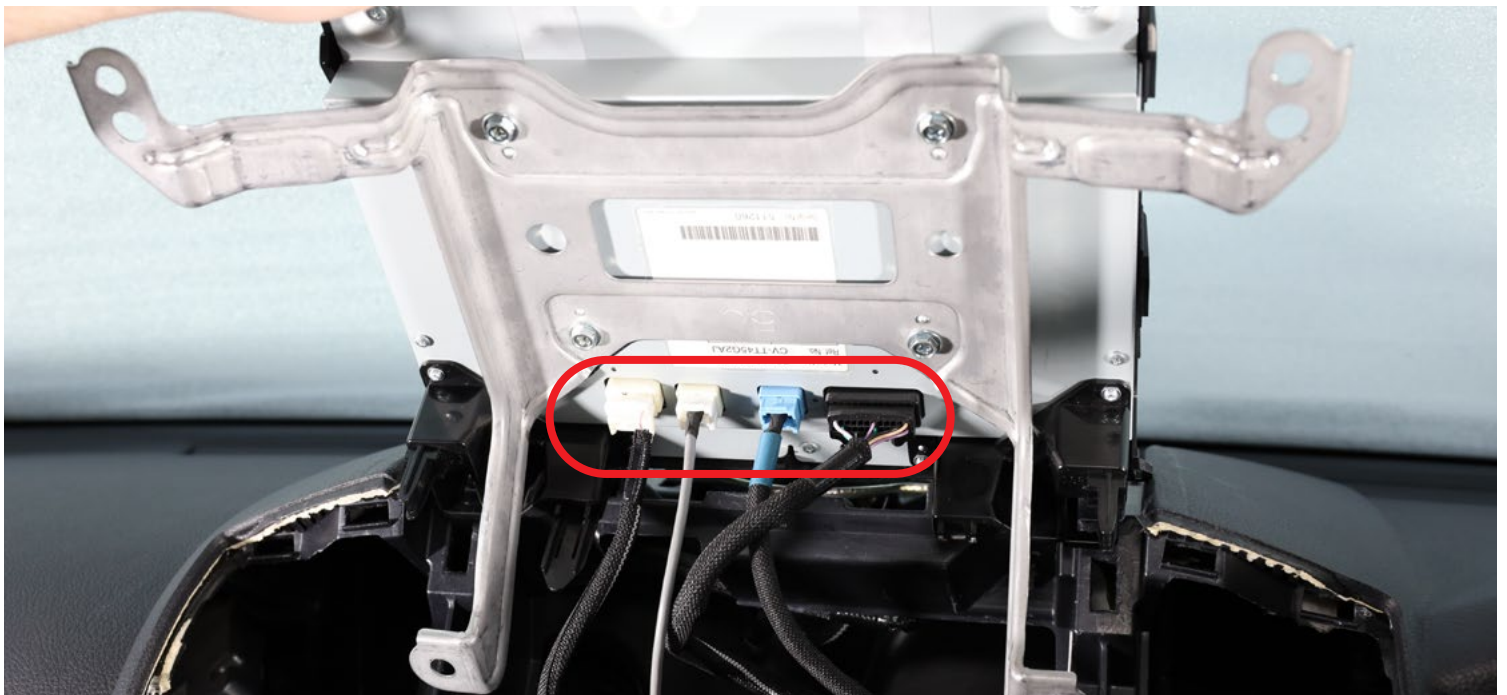

Dash disassembly cont.....

Remove the 2x 10mm bolts from behind the original screen indicated in figure 7 and place them aside.

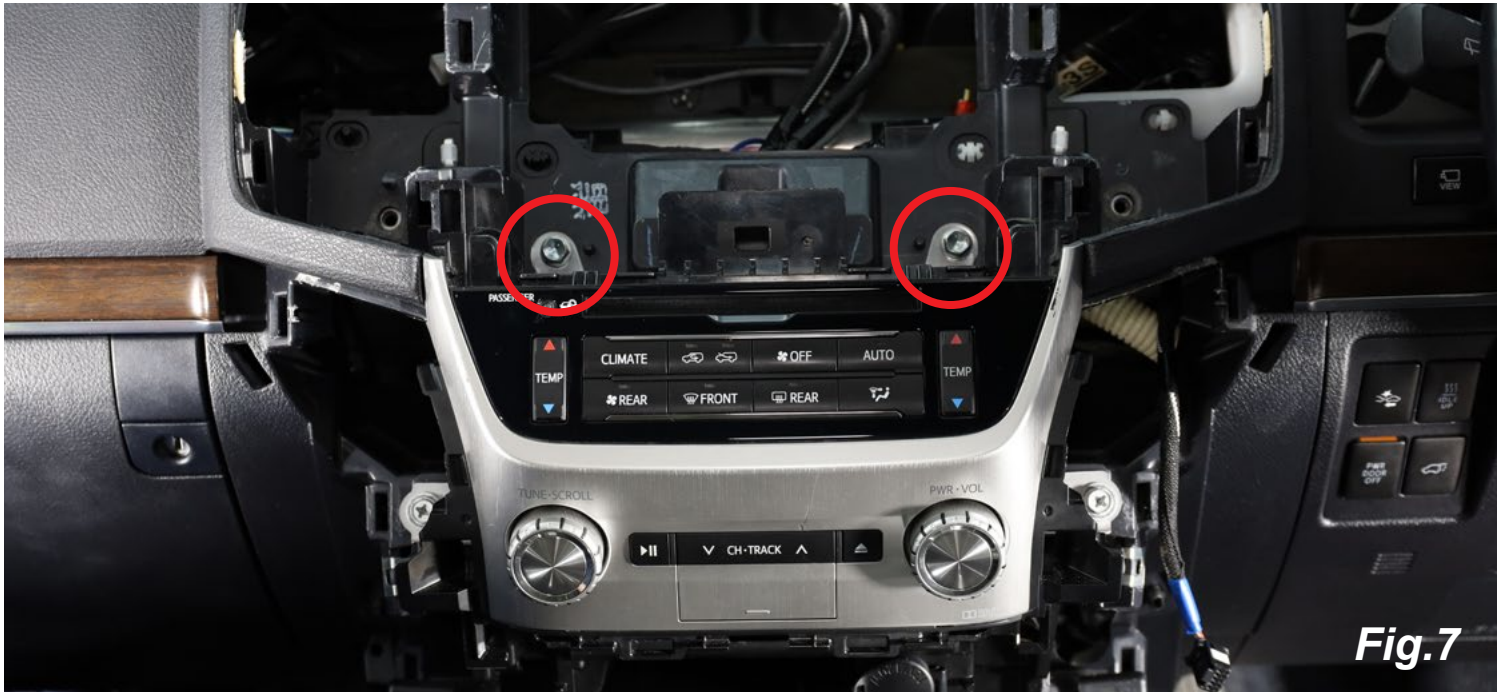

Fig.7

Remove the 2x 10mm bolts from beside the 2x original dials indicated in figure 8 and place them aside.

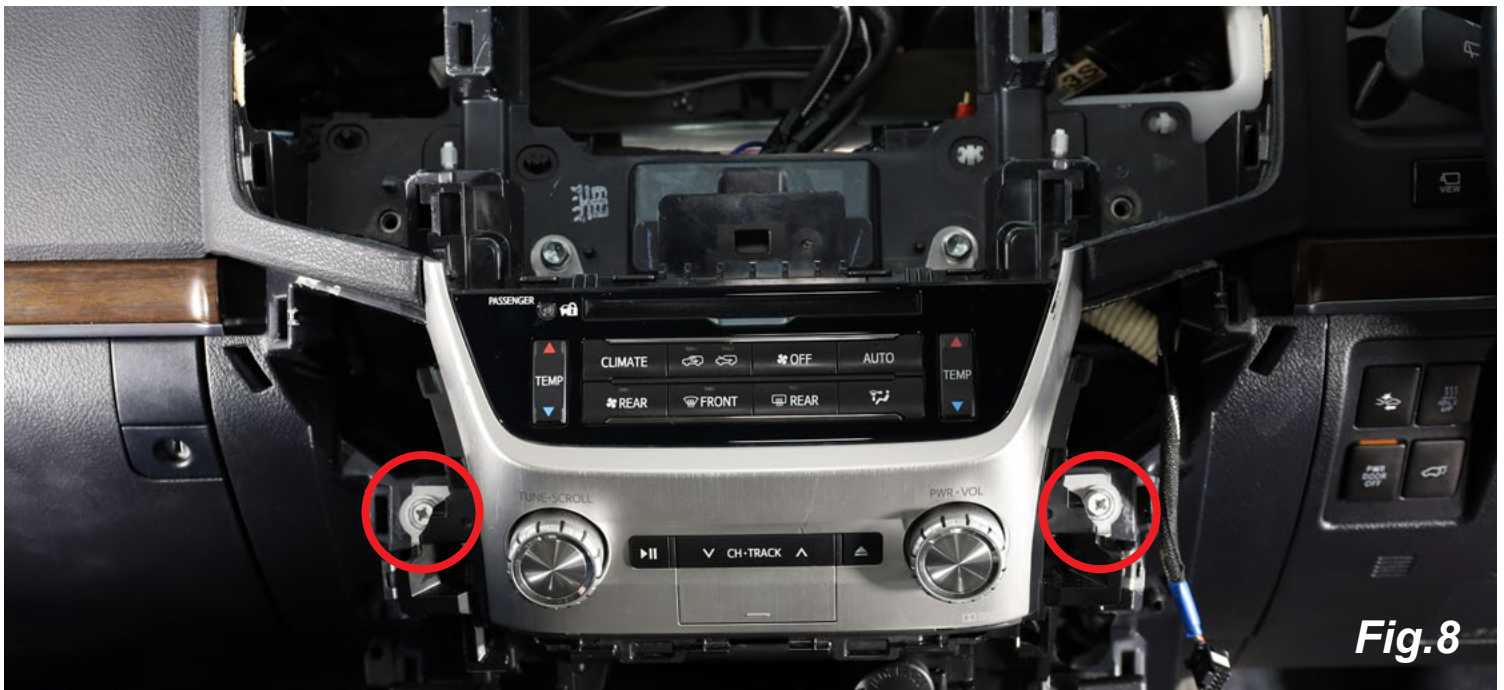

Fig.8

Dash disassembly cont.....

Remove the original climate controls and stereo dials by pulling them firmly toward the rear of the vehicle. Once the clips have been released you can access and disconnect the 9x harnesses. Place this unit aside.



Dash disassembly cont.....

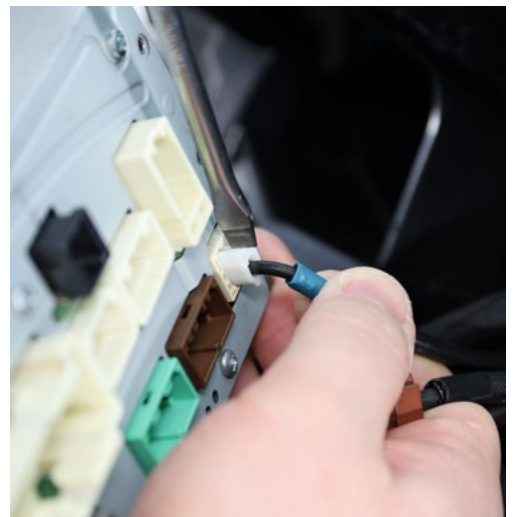
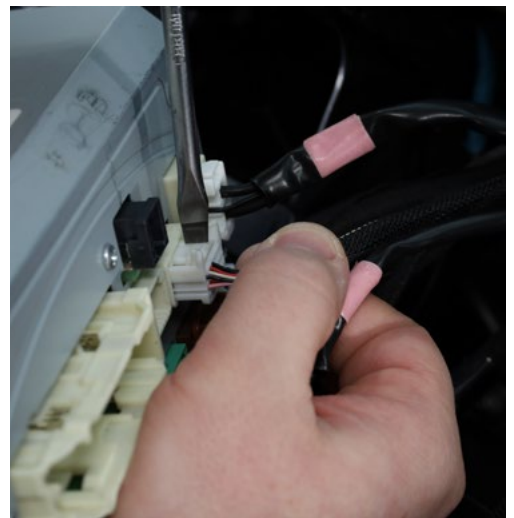
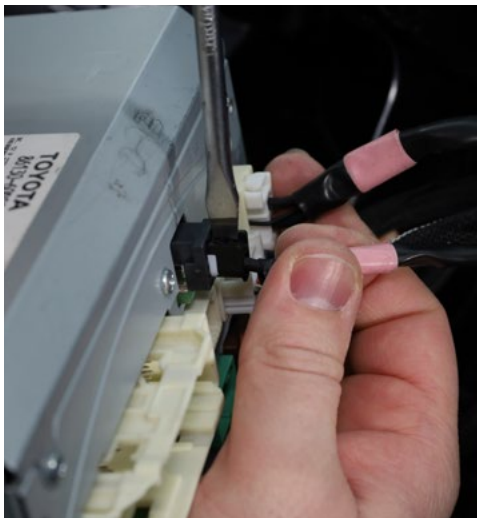
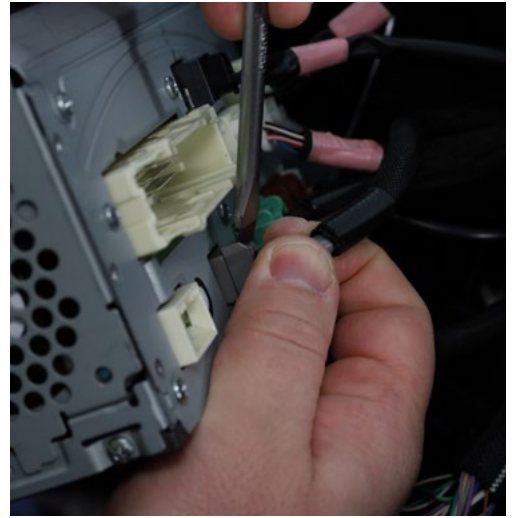
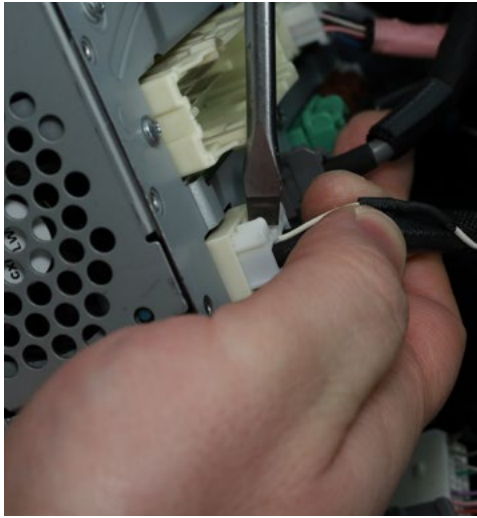

Head unit assembly

On a workbench attach the mounting brackets to the new head unit using the 8 x supplied Phillips head screws. The brackets and new head unit chassis are marked "L" and "R" to designate which sides they are to be mounted to.



Head unit assembly cont.....

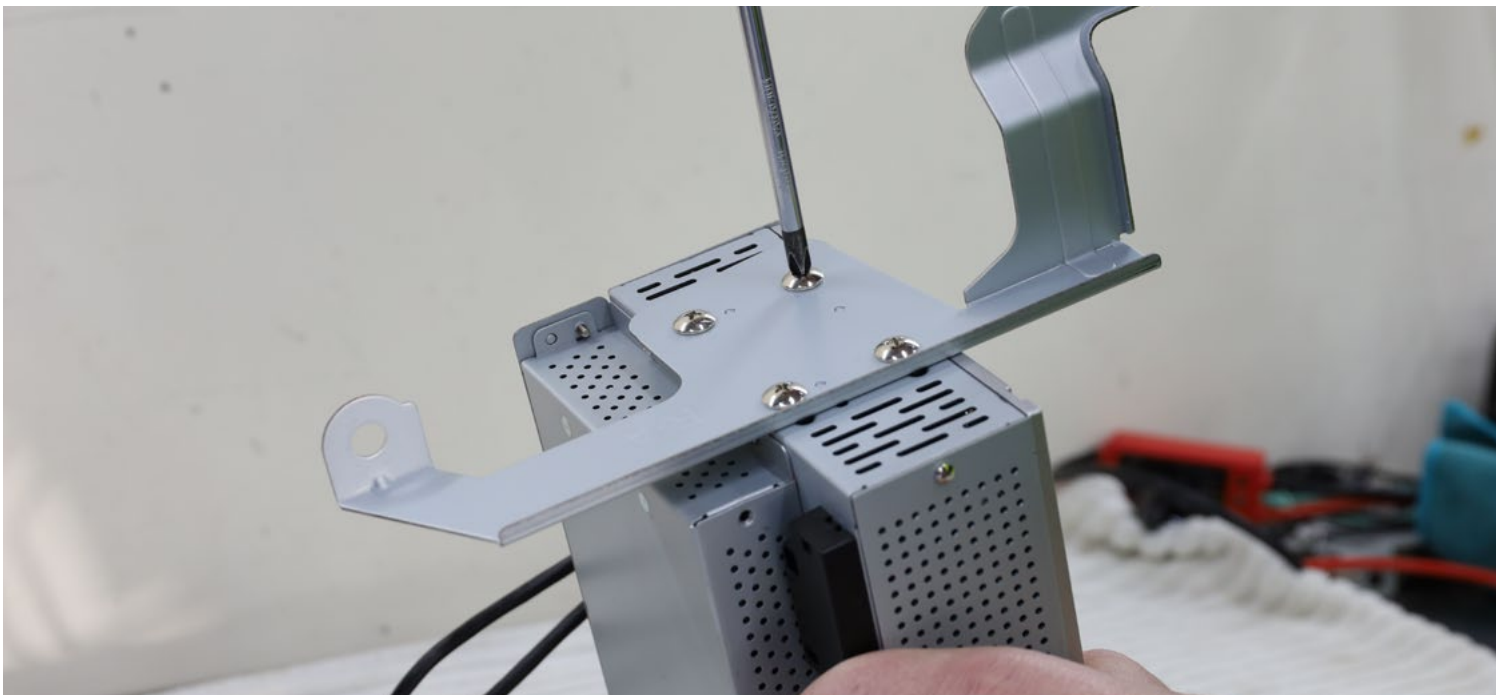
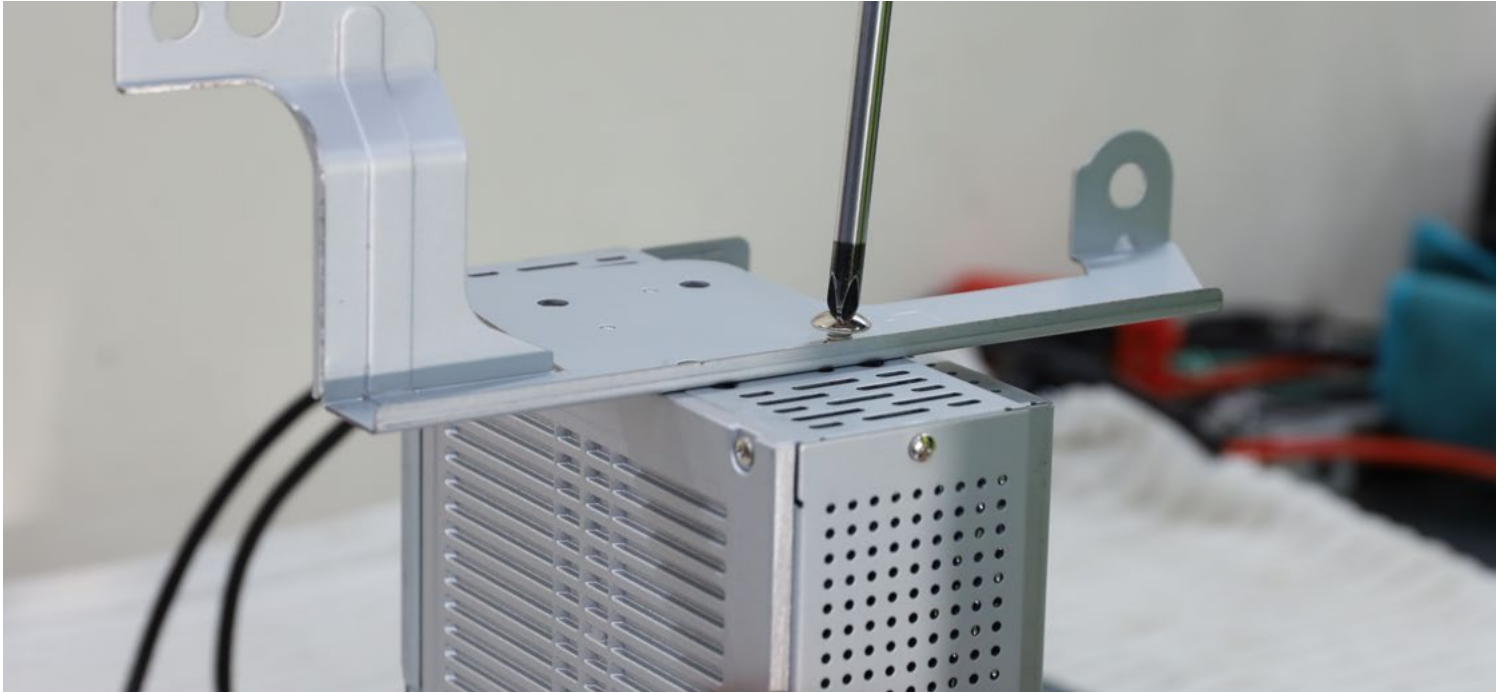

Wiring

Connect the wiring harnesses supplied with the new kit to the new head unit as indicated in the wiring diagram on pages 3-4 and then to the vehicles original harnesses

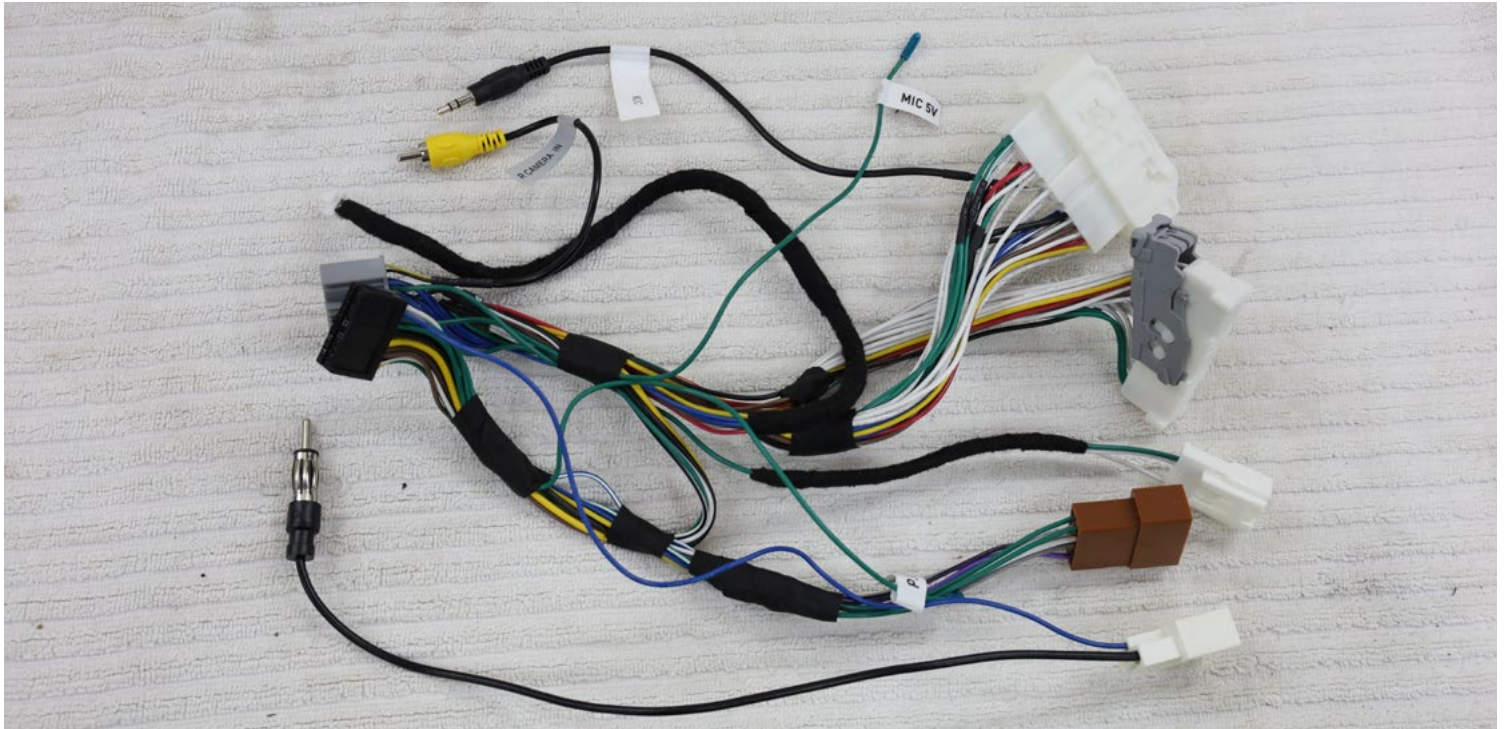

NOTE: The following connections need to be made to the head unit while on the workbench. Main power harness (black 20-pin plug) (13)

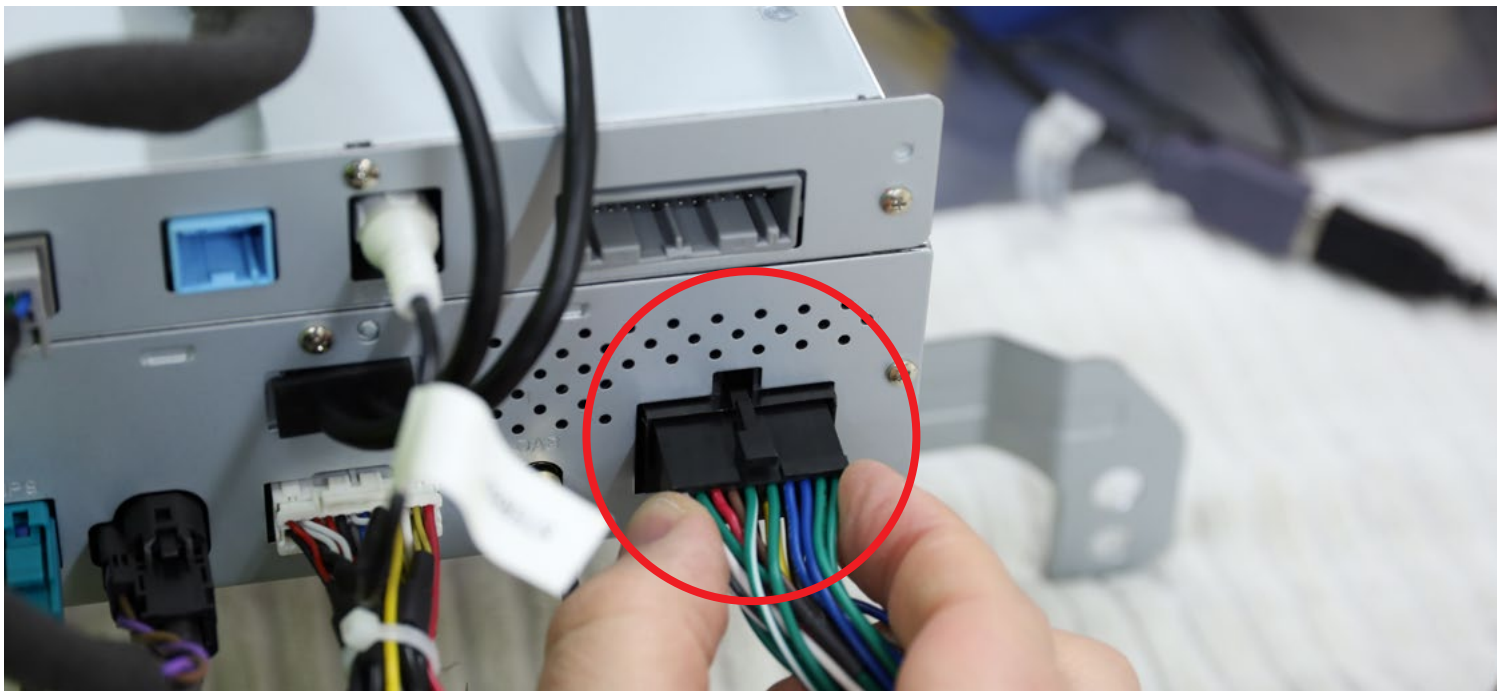

Wiring cont.....

Multiplex harness (grey 28-pin plug) (6)

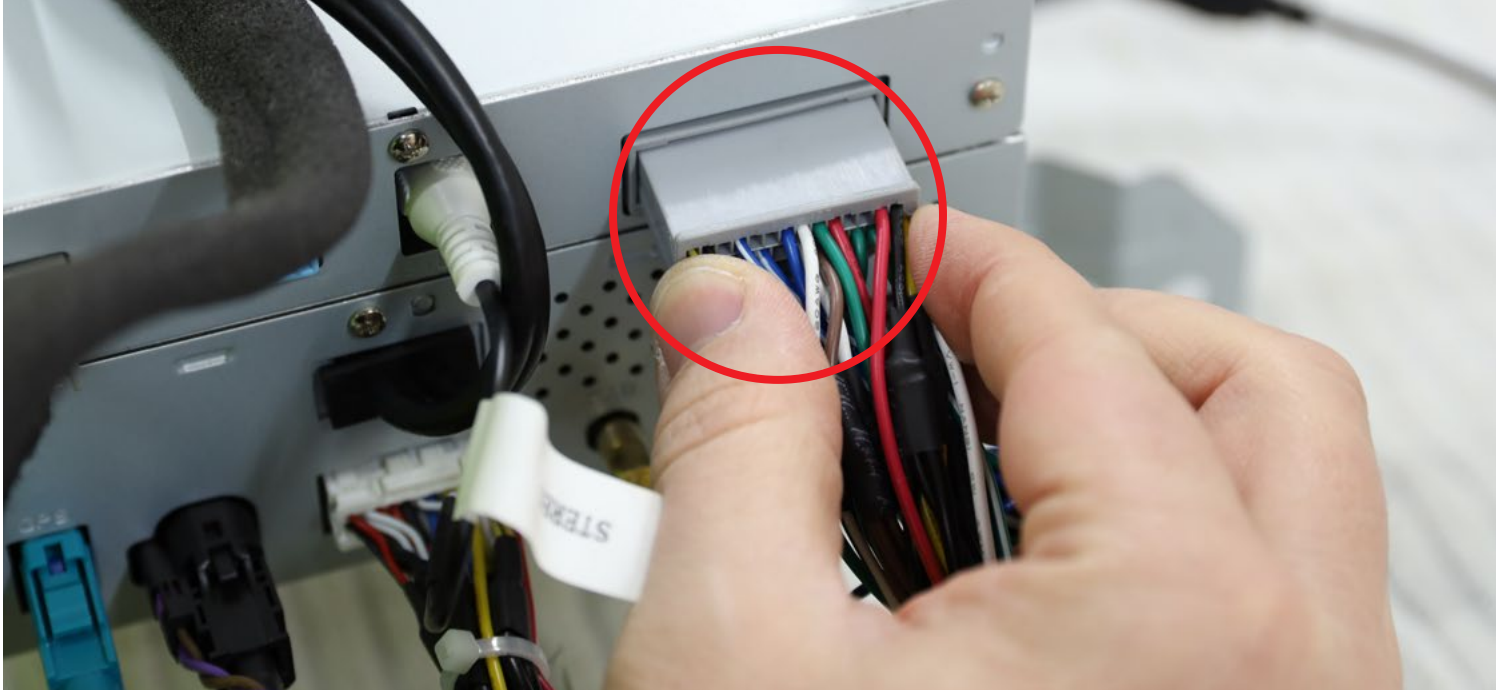

AV harness (white 24-pin plug) (11)



Wiring cont.....

AM/FM antenna adaptor plug (7)



GPS antenna adaptor plug (8)

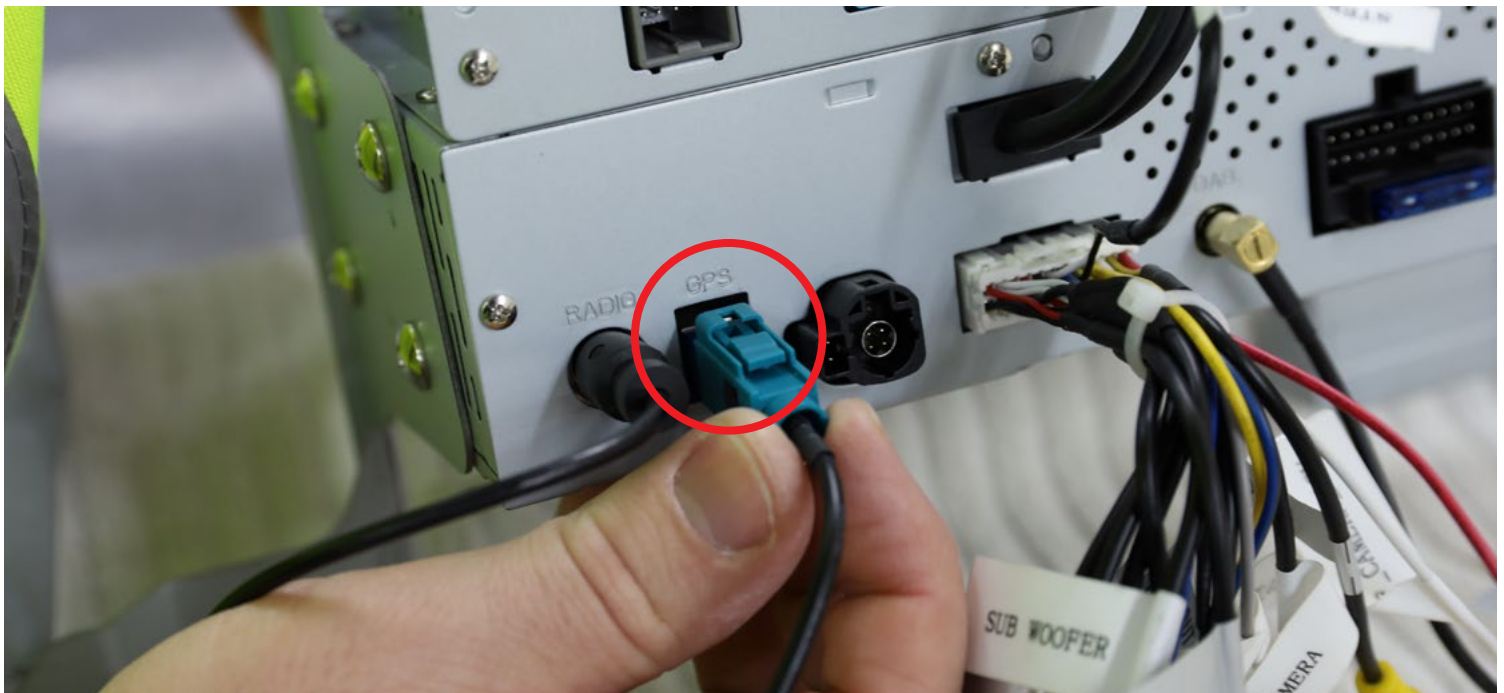

Wiring cont.....

LVDS lead plug (1)



DAB antenna adaptor plug (12)



Wiring cont.....

Stereo RCA (white RCA plug from AV harness labelled "Stereo" connects to RCA socket labelled "Stereo") (5)



MOST harness (grey 8-pin plug) (3)



Wiring cont.....

Attention: Vehicles without 360 camera (Reverse Camera Models).

Your factory reverse camera is required to be upgraded using the supplied AHD 720p reverse camera. This kit has not been configured to retain the original reverse camera as it is low resolution. Upgrading the camera is necessary to retain the reverse camera function.

Supplied is an AHD 720p camera designed for replacing the reverse camera of your non-360 camera vehicle. However if you have a vehicle with 360 camera support, this can instead be used as a secondary camera.

You can wire it up using the reverse lights of the vehicle or connect it to the head units AV harness's camera power outputs (R. Camera 12v Out / F. Camera 12v Out)

NOTE: Putting the vehicle in reverse will send 12v out from the 'R. Camera 12v Out' cable. Pressing the second camera icon on the homescreen will send 12v out from the F. Camera 12v Out cable.

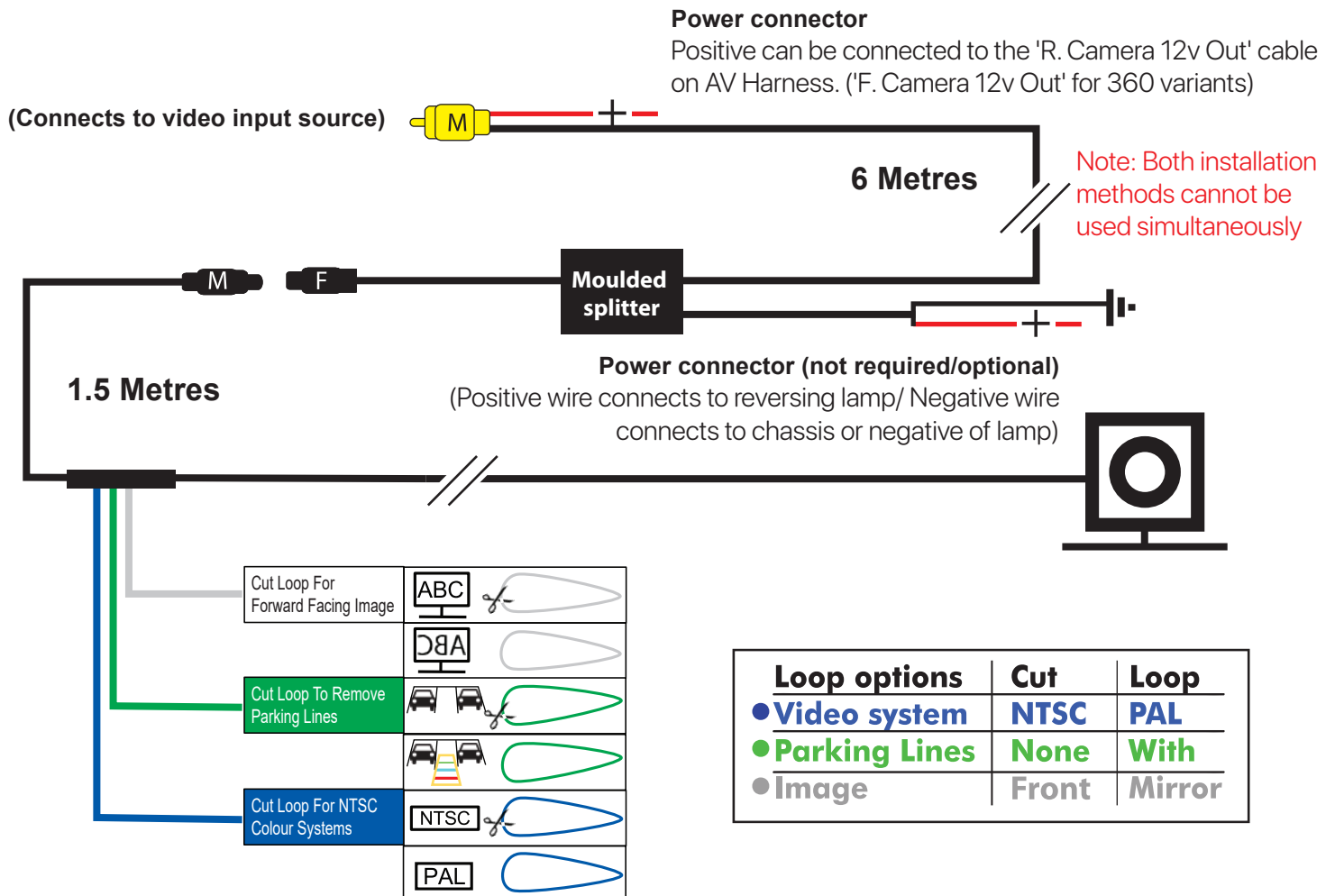

Wiring cont.....

NOTE: The following connections need to be made to the head unit in the vehicle.

The following leads pictured below are required to retain the Hazard switch and 360 degree camera. The white 12-pin Hazard switch plug in the vehicle will connect to the white 12-pin Hazard switch socket of the new harness (14). The square 360 degree camera plug connects to the 360 degree camera socket on the back of the new unit (4).

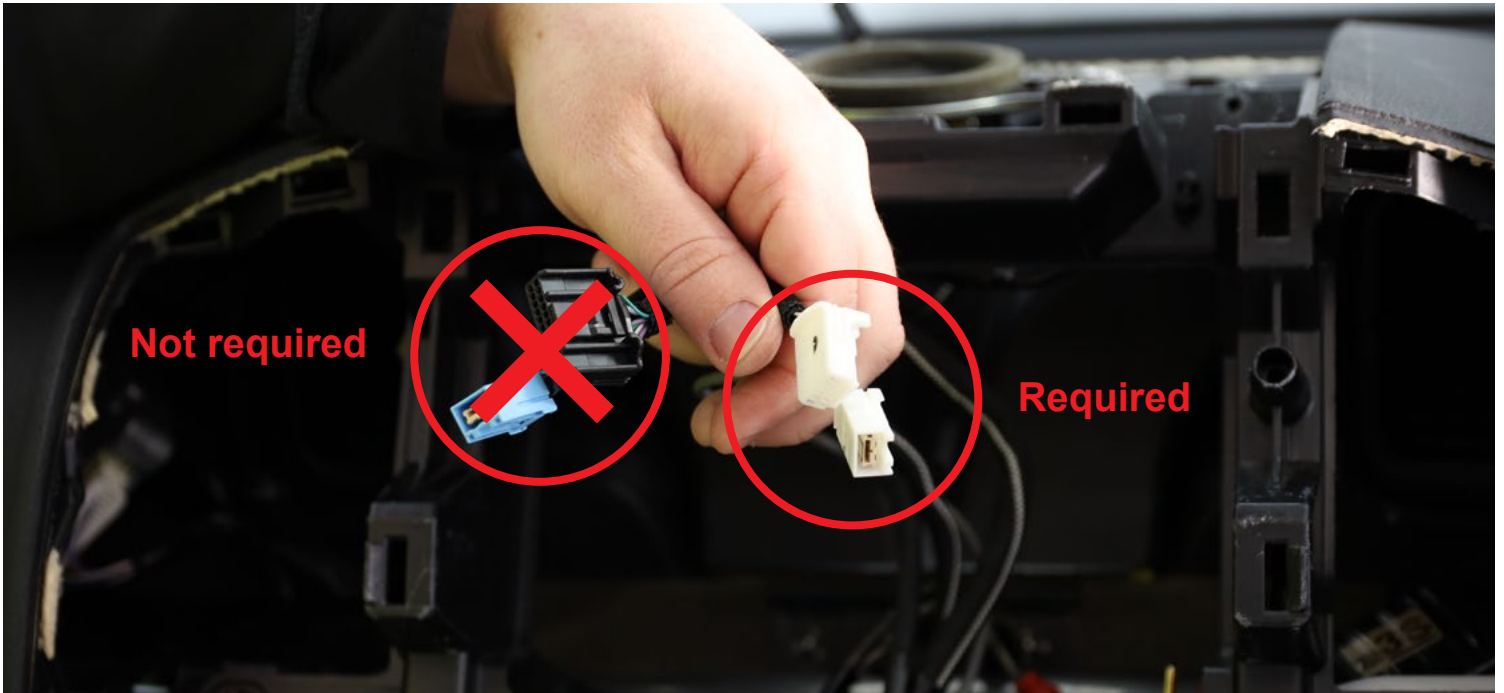

Connect the 360 degree camera harness (4). For the Australian region, **the 360 camera plug is white or black and not blue.** If your vehicle has a 360 camera connector like Figure 9 you can plug the white connector straight into the back of the head unit. If your 360 camera vehicle connector is like Figure 10, then you will need to use the included 360 camera adaptor to convert the 360 plug, and then connect it to the back of the head unit.

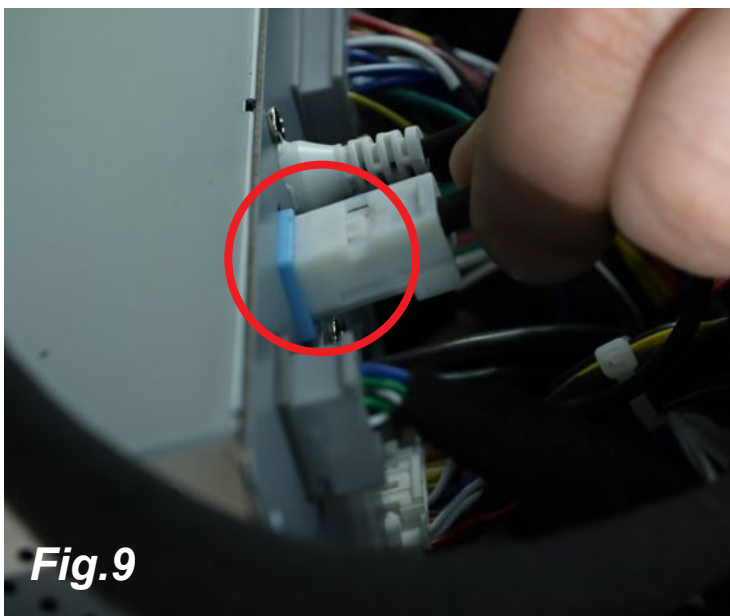

Wiring cont.....

The following leads are to be routed beside or underneath the new head unit but above the plastic dash support (these will connect to the new display): LVDS lead (1)



Hazard switch and climate display harness (white 8-pin plug) (2)

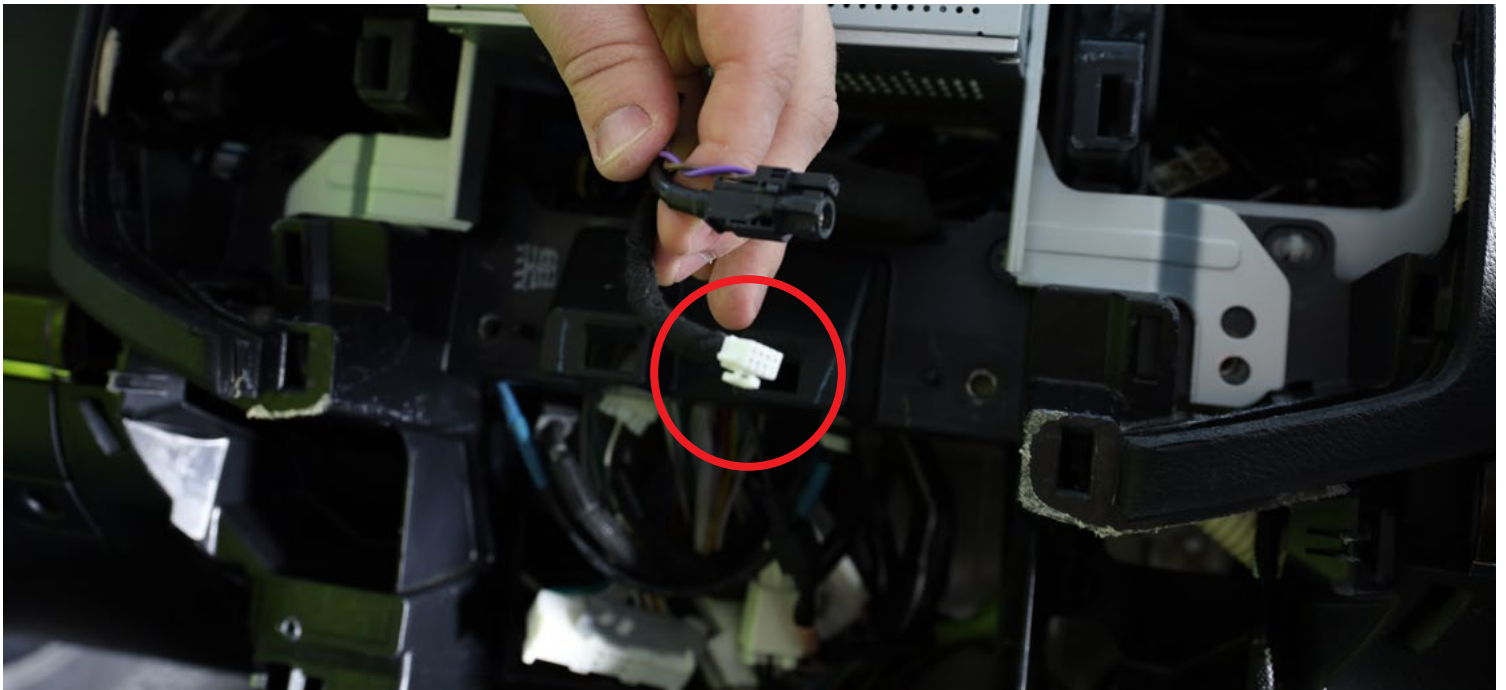

Wiring cont.....

The following leads are to be routed down behind the plastic dash support and connected to their corresponding original harnesses.

AM/FM antenna adaptor (7)

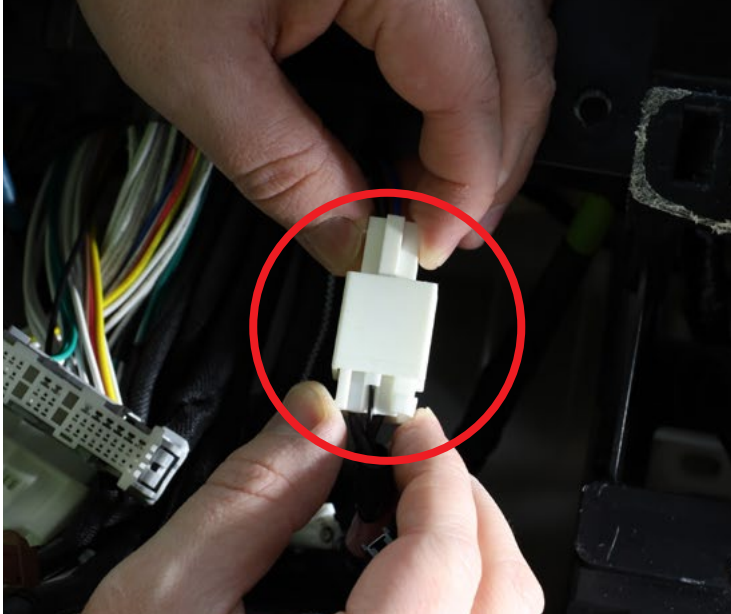

GPS antenna adaptor (8)

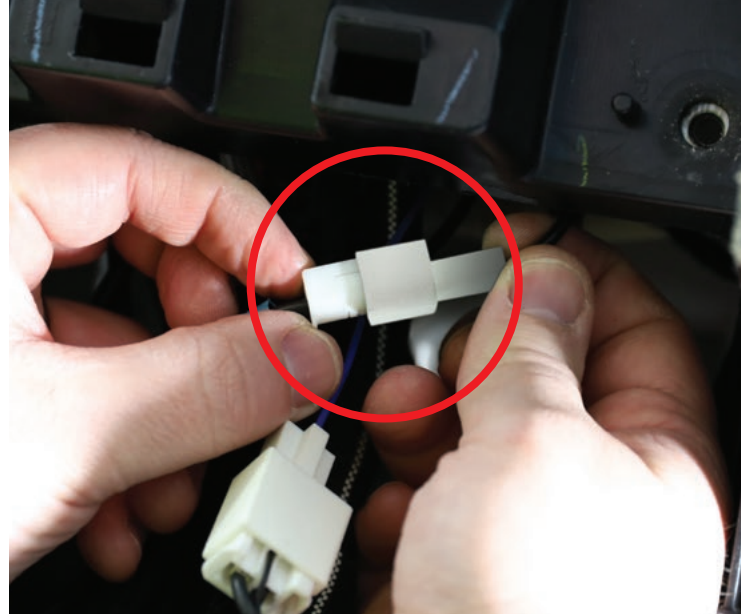

DAB antenna adaptor (12)

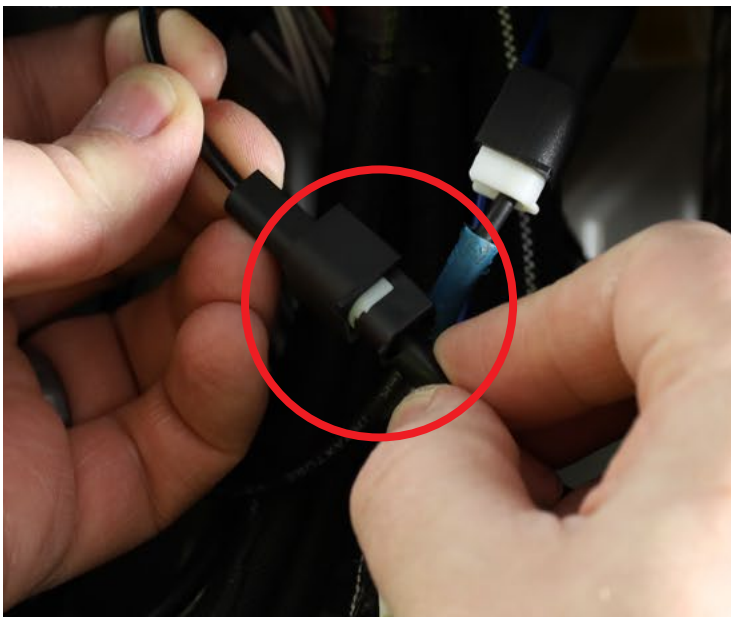

Wiring cont.....

The following leads are to be routed down behind the plastic dash support and connected to the original climate control system. Locking multiplex harness (white 59-pin plug and socket)
The new 59-pin plug is to be connected to the socket of the original head unit.

NOTE: Make sure that the connection is done slowly, ensuring that all the pins make contact and aren't bent or loose on installation.

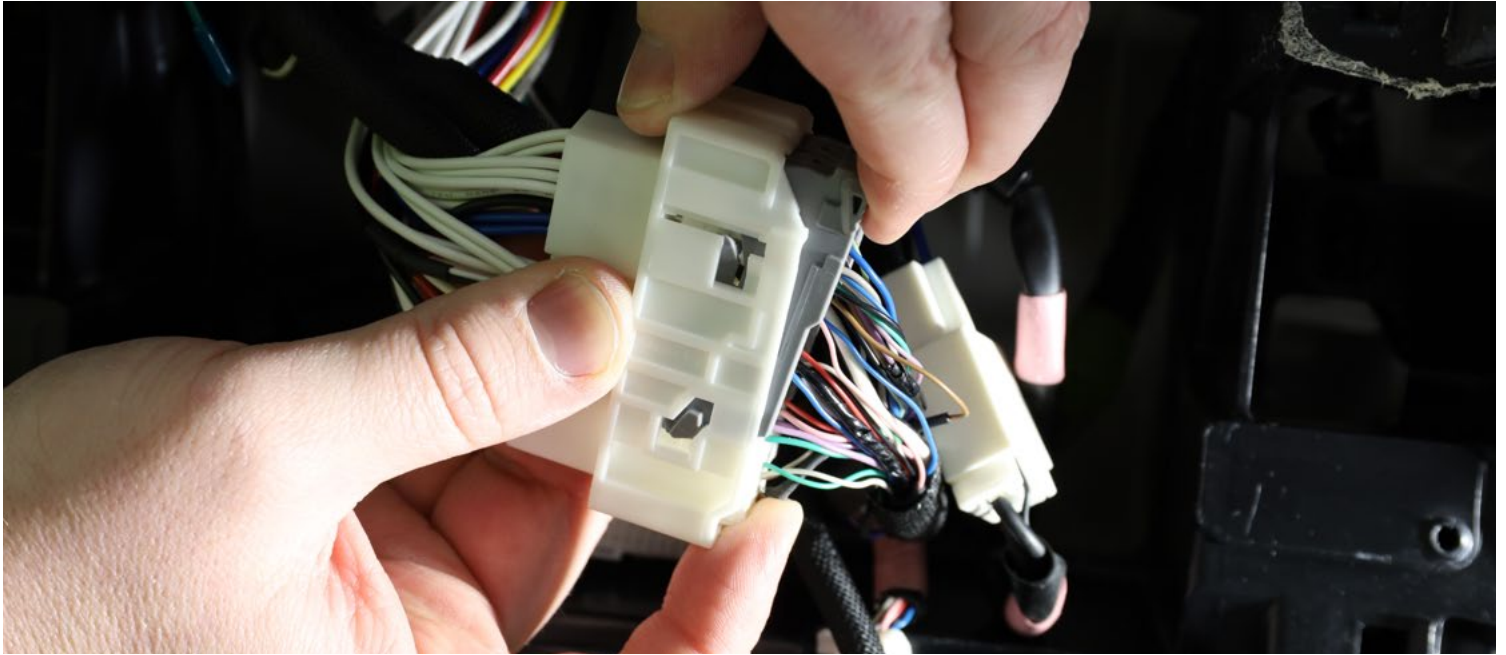

The new 59-pin socket is to receive the original 59-pin plug which was disconnected from the original climate control system.

Do not connect anything other than the 59-pin plug to the back of the climate control system. Connecting other factory plugs may interfere with the functionality of the new head unit.



Dash reassembly

The new head unit can be secured into the dash using 4x of the 10mm bolts which have been placed aside.

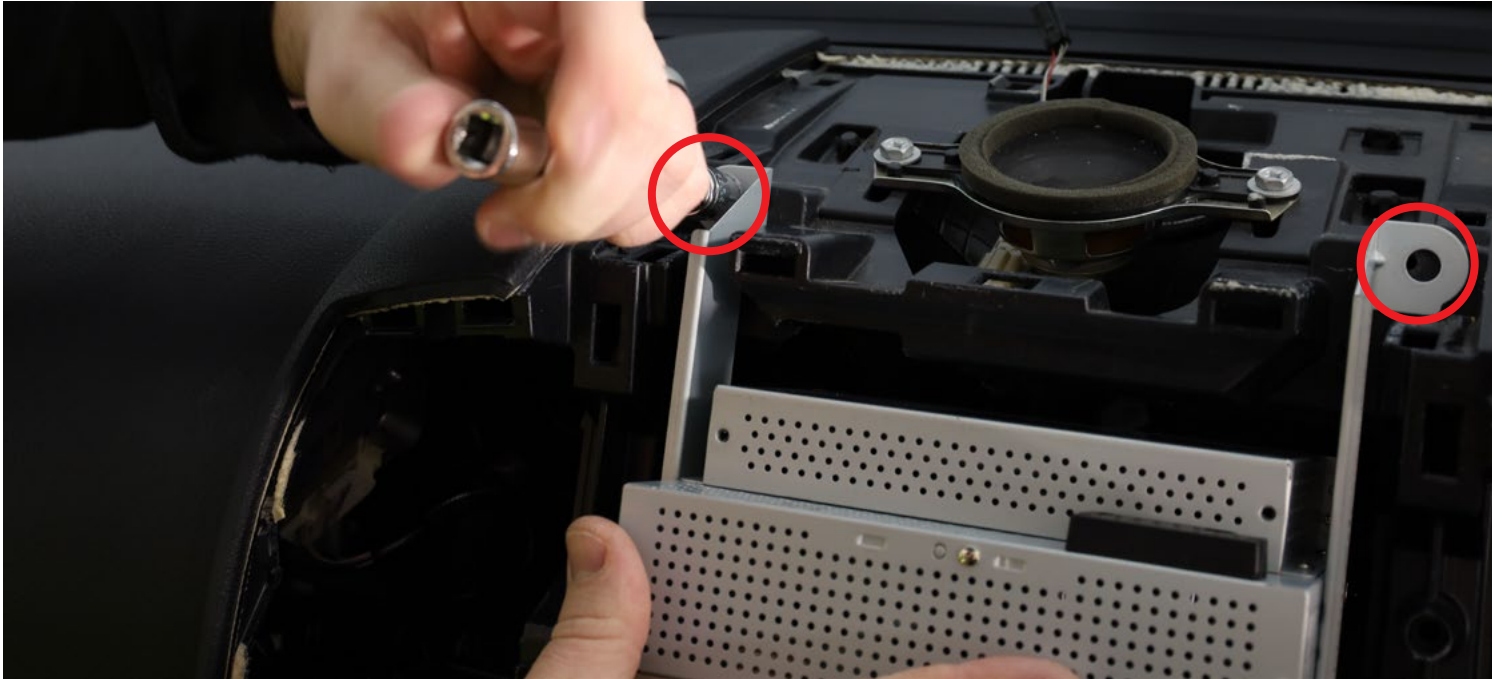

Dash reassembly cont.....

The original head unit including the original climate controls can be secured into the dash using 4x of the 10mm bolts which have been placed aside.

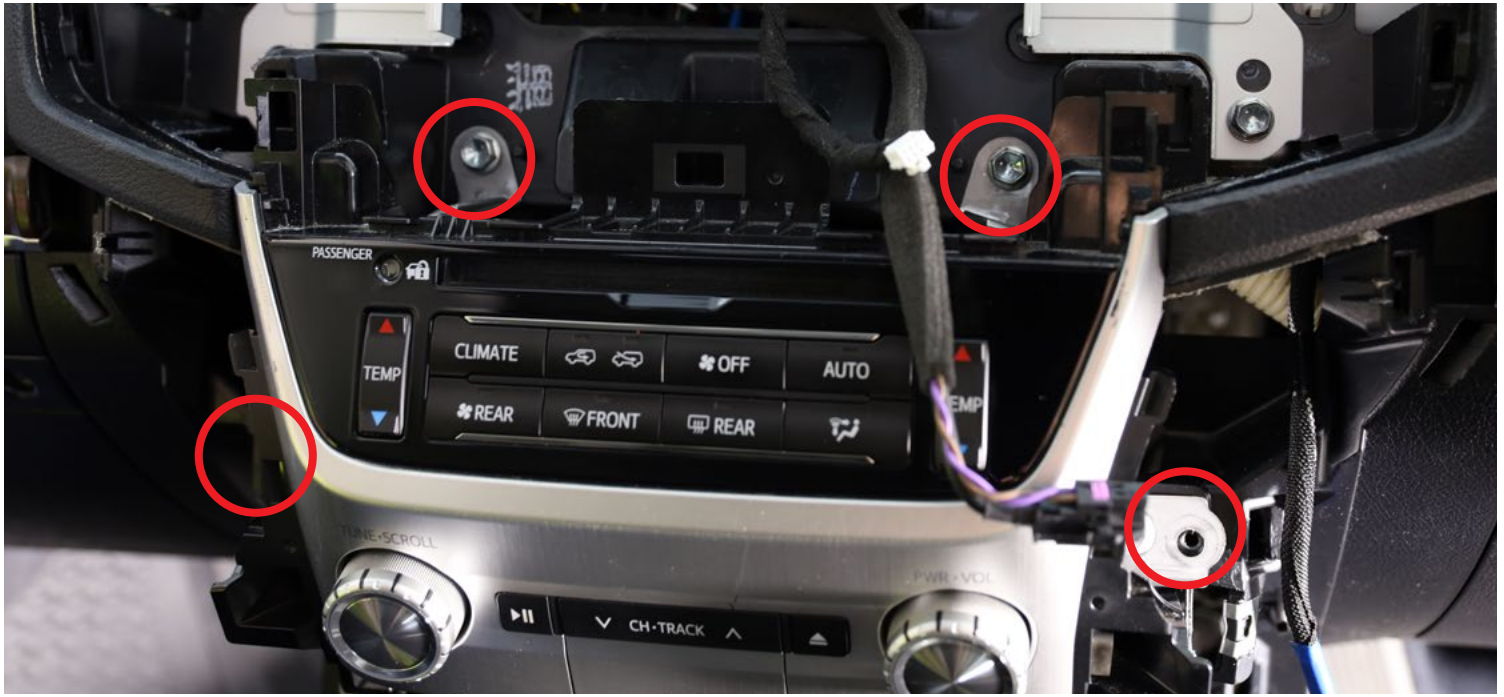

The new display can be connected using the LVDS plug (1) and the hazard switch plug (white 8-pin plug) (2)

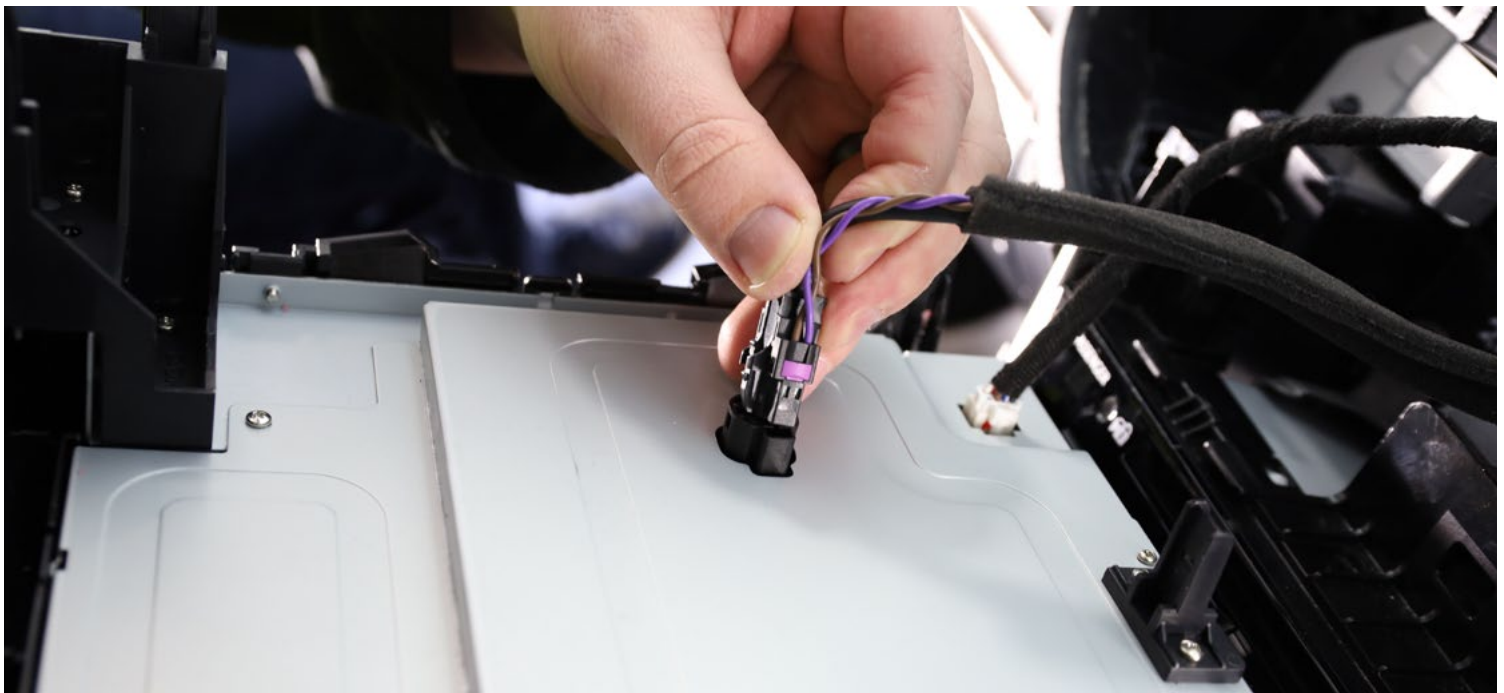

Dash reassembly cont.....

The new display can be clipped into its place by firmly pushing it in with even pressure by hand.



The dash top panel can be replaced by first connecting the original light sensor harness and then clipping it into place by firmly pushing it down with even pressure by hand.



Dash reassembly cont.....

The air vents can be replaced by firmly pushing them into place with even pressure by hand



The pocket below the original stereo can be replaced by firmly pushing it into place with even pressure by hand. (You may require the harnesses to be reconnected before replacing this panel).



Dash reassembly cont.....

The transmission lever can now be returned to the Park position and the shift lock cover replaced



The start / stop button can be reconnected.

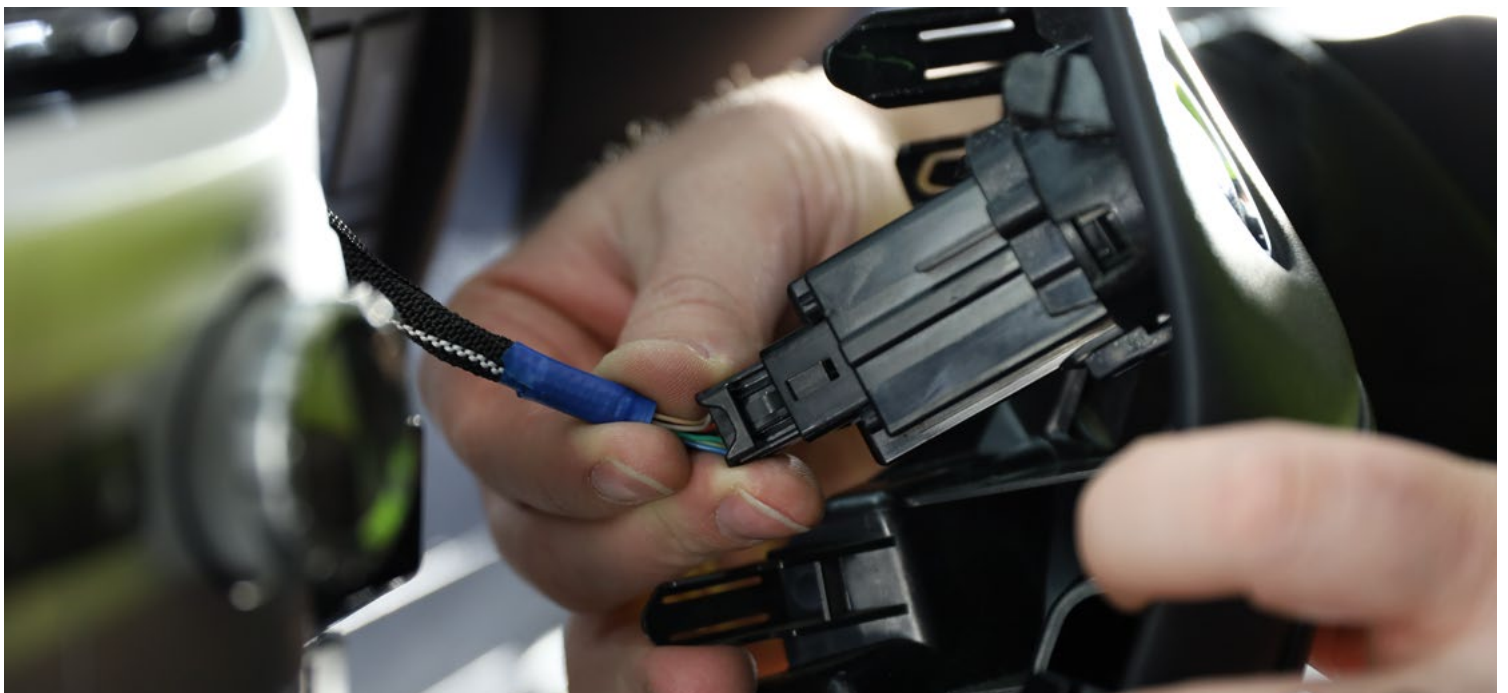

Dash reassembly cont.....

The panel and its equivalent on the passenger side can be clipped back into place and secured with the 2x remaining 10mm bolts



The panels by the drivers left knee and the passengers right knee can both be clipped back into place

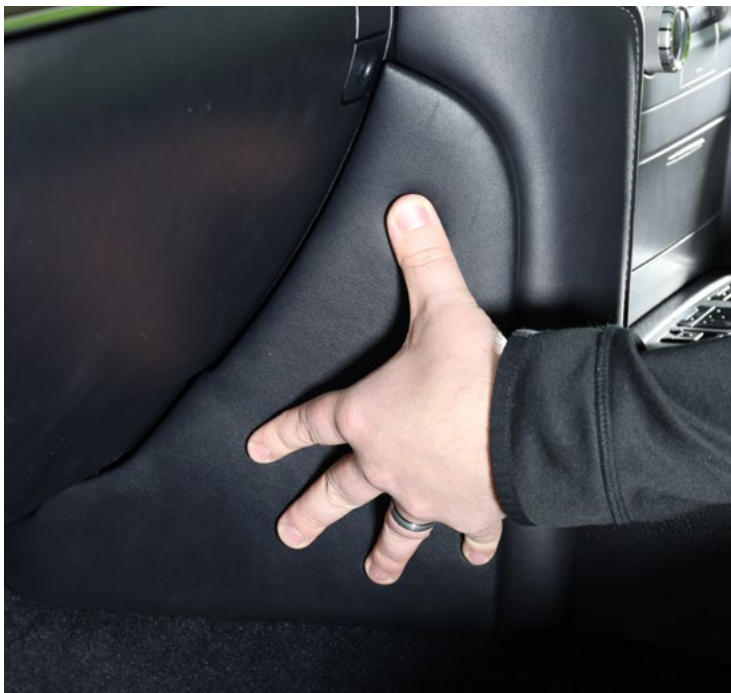

Testing the new unit

Perform the following checks to determine their functionality:

- AM / FM / DAB
- Apple CarPlay
- Android Auto
- Audio output and adjustment
- Bluetooth microphone
- Steering wheel controls
 - Volume up / down
 - Track change next/ previous
 - Mode
 - Voice control
 - Phone buttons answer / hang up
- USB ports
- 360 degree camera
 - View change button
- Parking sensors front / rear
- Climate controls
 - AC function
 - Temperature up / down
 - Vent location
 - Air re-circulation
 - Fan speed
 - 4-zone setting
 - Demisters front / rear
 - Outside temperature
- Hazard light switch
- Factory vehicle settings
 - Sound settings
 - Rear system* (*Sahara only)
 - Door lock settings
 - Climate settings
 - Light settings
 - Toyota park assist settings
- Inclinator (after calibration, refer user manual)
- Second camera (if fitted)



10" ADVANCED INFOTAINMENT SYSTEM

INTEGRATED HEAD UNIT UPGRADE

to suit **TOYOTA LANDCRUISER 200 SERIES VX/SAHARA 2016-2021**



AMUTO53

USER MANUAL

CONTENTS

The Basics.....	2
The Home Screen.....	5
Climate - Front.....	7
Climate - Rear.....	8
FM Radio.....	9
AM Radio.....	10
DAB+ Radio.....	11
Inclinometer.....	15
Trip Information.....	17
USB Playback.....	18
Devices Connect.....	20
Settings - General.....	21
Settings - Audio.....	22
Settings - Audio - Volume Control.....	23
Settings - Audio - Equaliser.....	24
Settings - Audio - Balance.....	25
Settings - Audio - Time Alignment.....	26
Settings - Audio - Filter.....	27
Settings - Display.....	28
Settings - Car Settings.....	29
Settings - Car Settings - Car Colour.....	30
Settings - Car Settings - Sound Settings.....	31
Settings - Car Settings - Rear System.....	32
Settings - Car Settings - Door Lock Settings.....	33
Settings - Car Settings - Climate Settings.....	34
Settings - Car Settings - Light Settings.....	35
Settings - Car Settings - Park Assist Settings.....	36
Settings - Other.....	37
Park Assist Screen.....	38
Wired & Wireless CarPlay Operation.....	39
Wired & Wireless Android Auto™ Operation.....	40
How To Use CarPlay®.....	41
How To Use Android Auto®.....	42
Specifications.....	43
FAQ.....	45
Technical Assistance.....	49

The Basics



Home Button
Jump to the Home Menu or switch between last source

Volume Down

Volume Up

Hazard Button

Fan Speed Down

Fan Speed Up

Climate Button
Quickly switch to the climate screen

The Basics cont.....

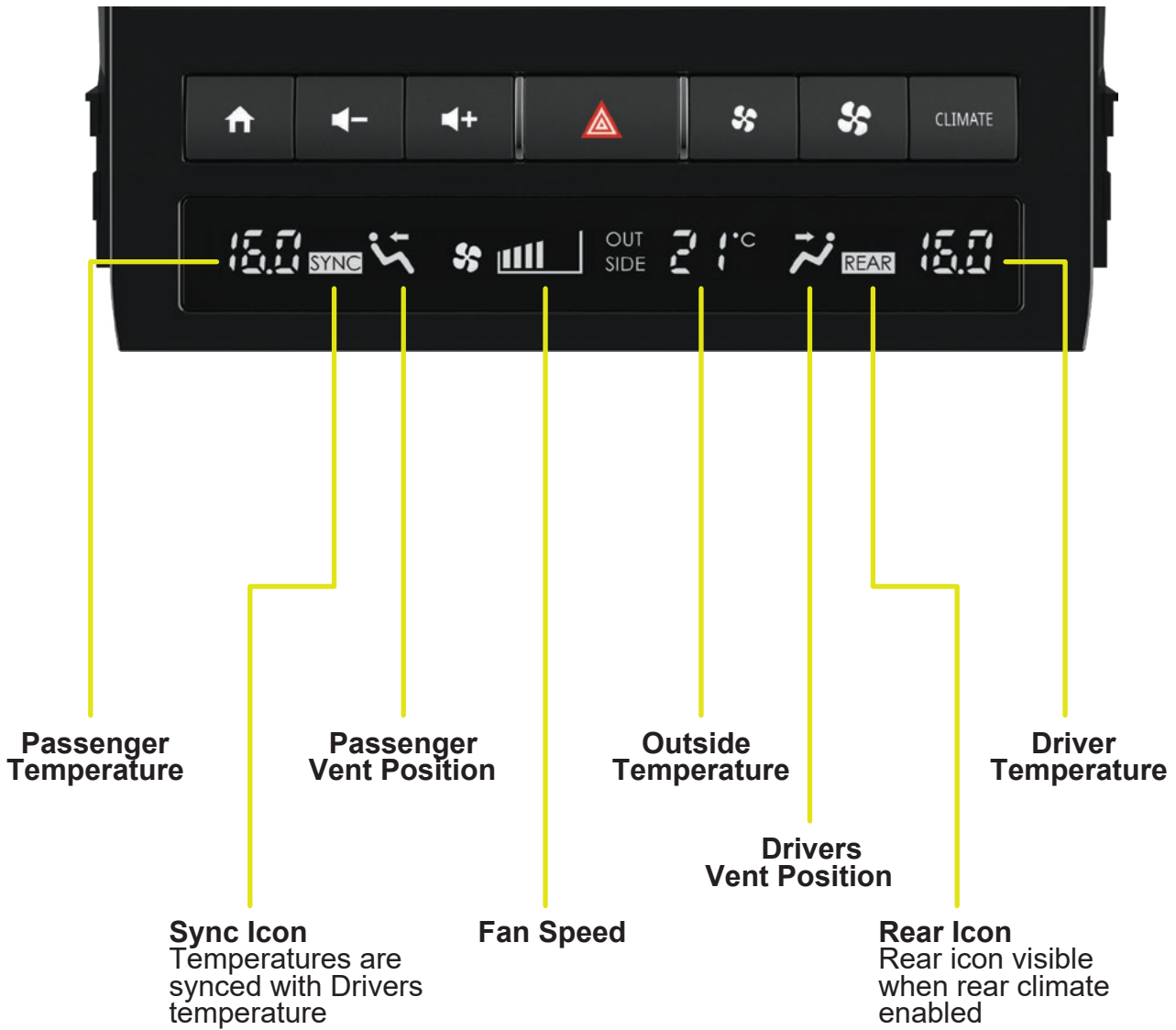

The Basics cont.....

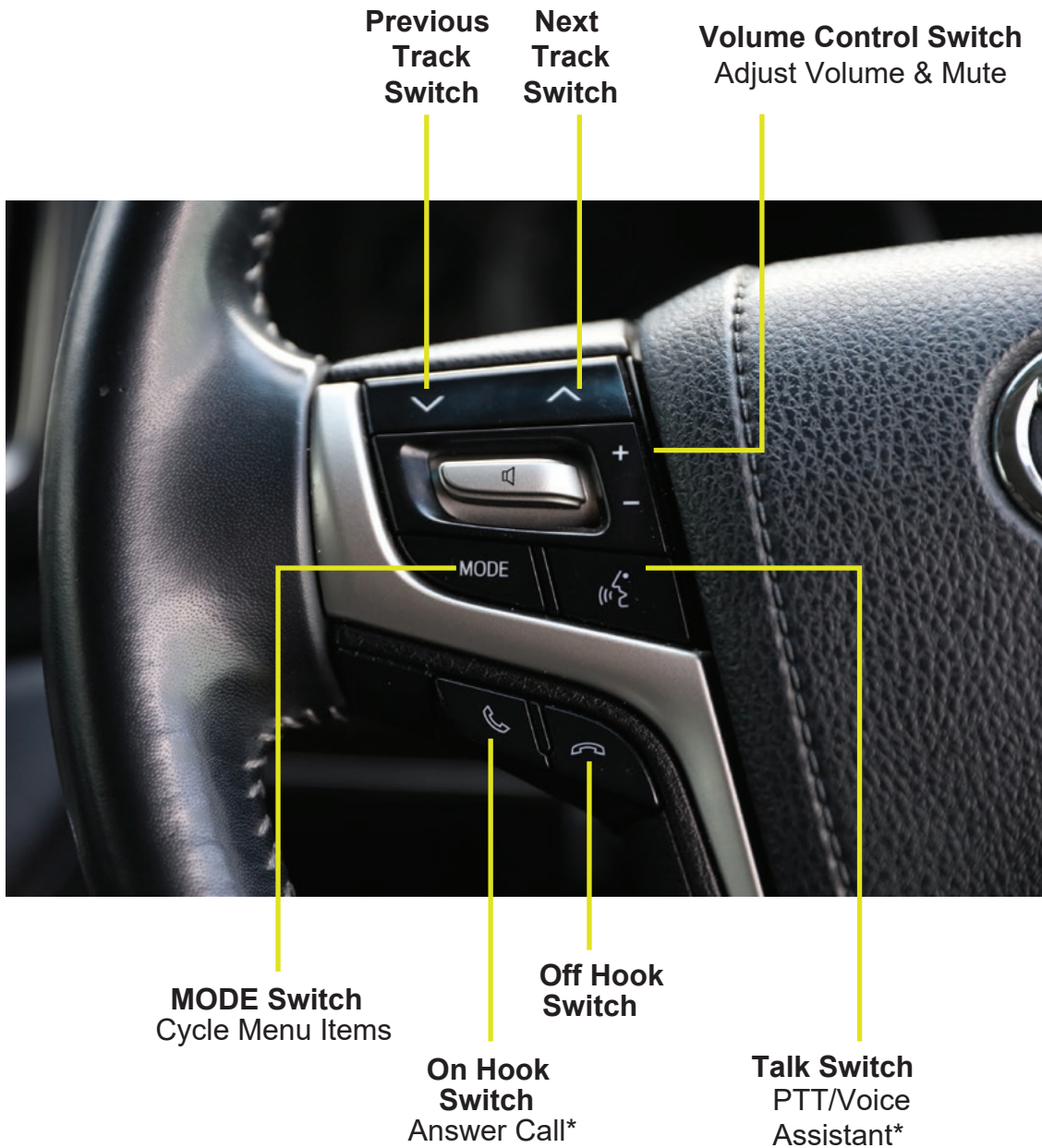

Holding down the Volume Down button on the steering wheel for 1 second will mute the audio. If you want to un-mute the audio, simply increase the volume.

* To use these buttons you will require a connection via Bluetooth or Android Auto/Apple CarPlay to the AMUTO53.

The Home Screen

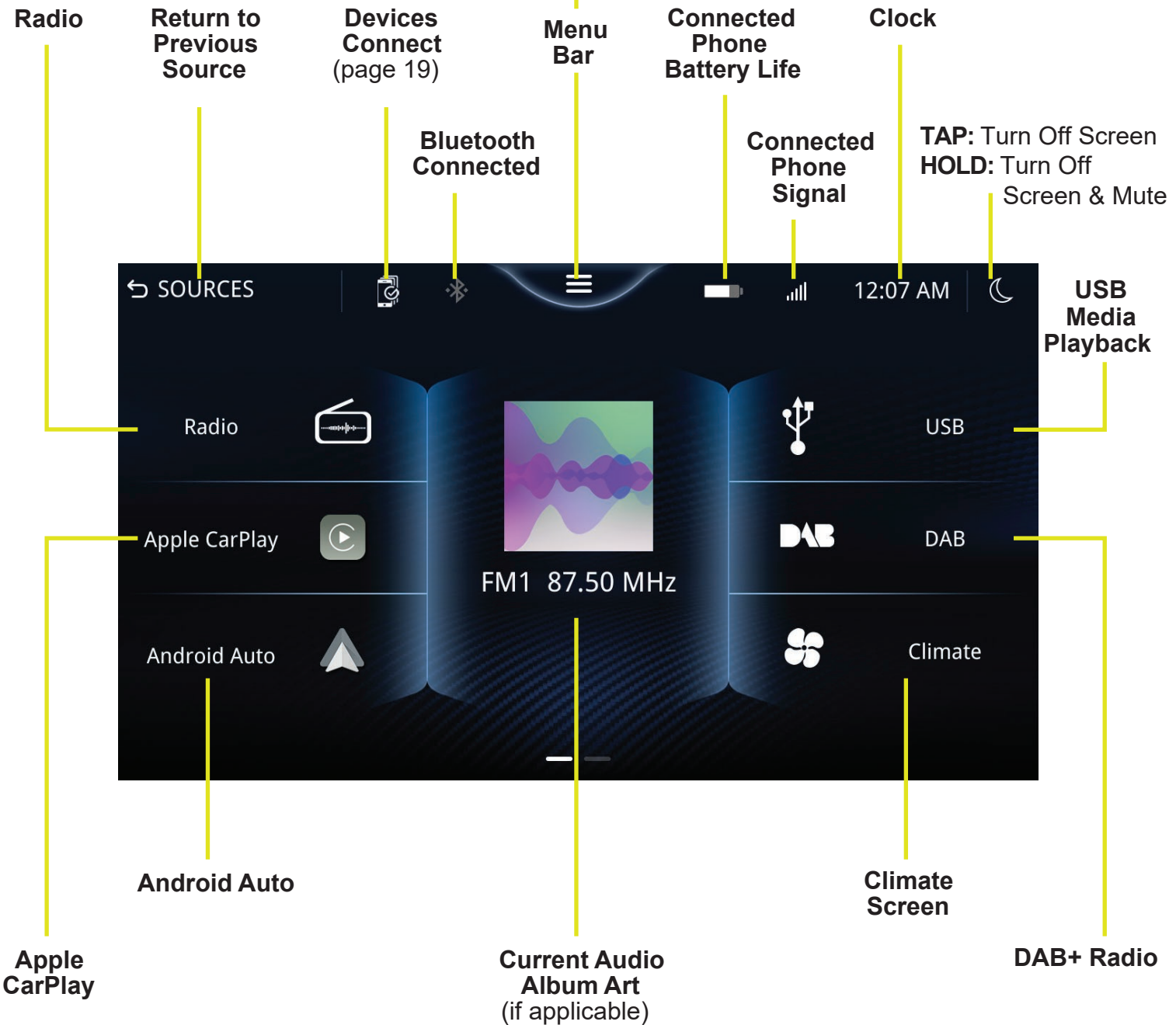
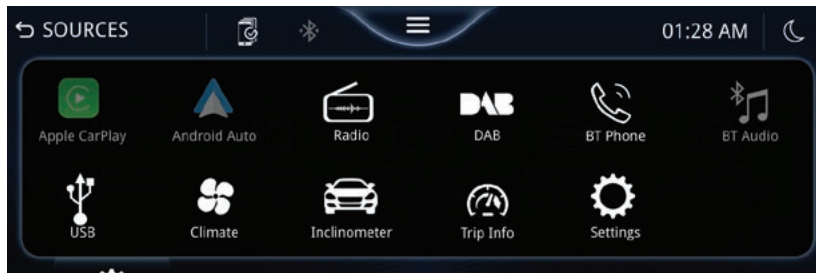

The Home Screen cont.....

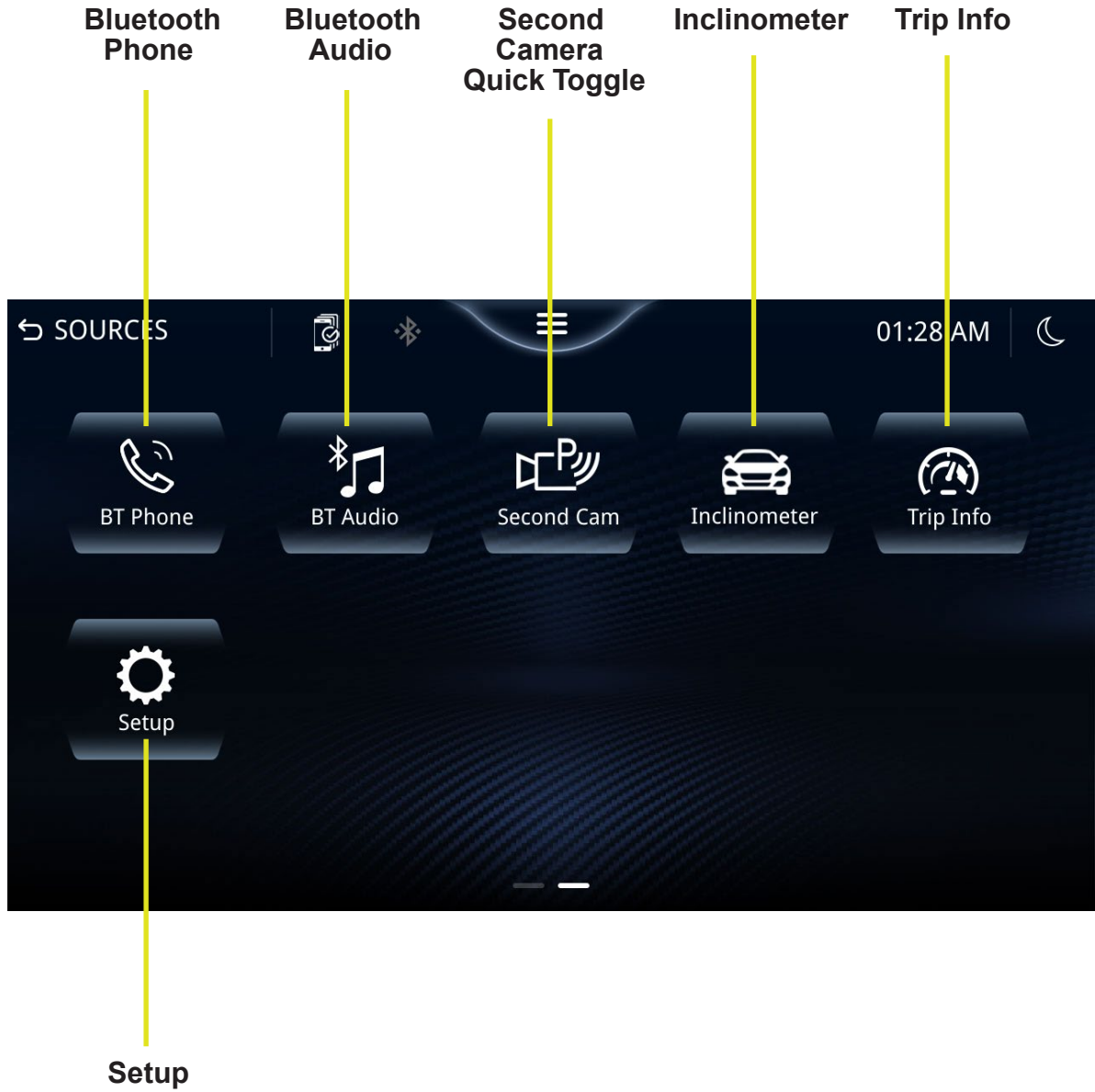

Climate - Front

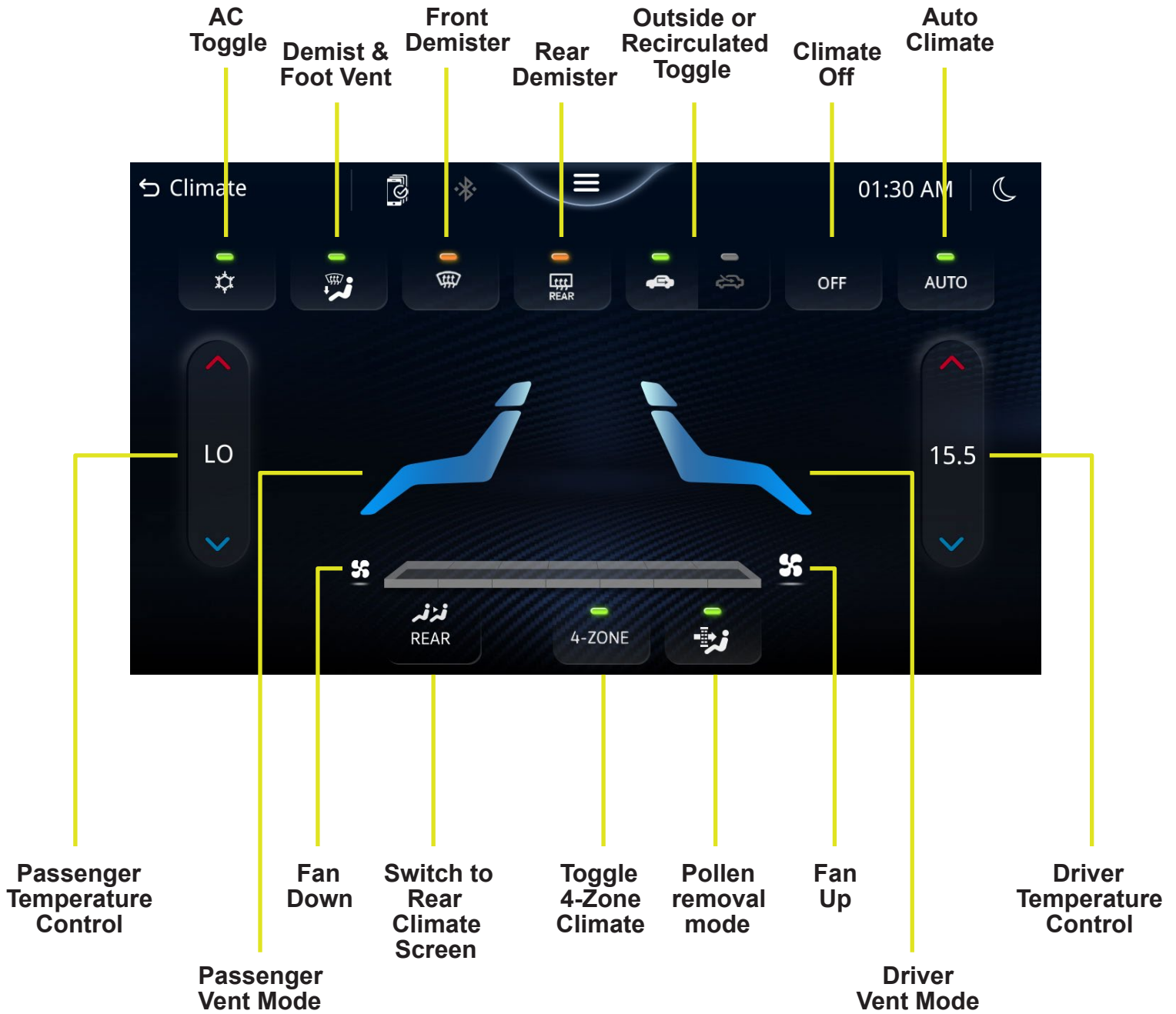

Climate - Rear



FM Radio



Auto tuning

Press the seek icon (◀ or ▶) on the screen to automatically seek to the next found station.

Manual tuning

Tap the ◀◀ or ▶▶ icon to increase / decrease the tuning frequency by one step at 0.05MHz increments for FM.

You can also drag the slider to quickly change the frequency to specified number.

You can also manually input a frequency using the keypad in the bottom right.

Once on a station you would like to save, simply tap and hold any of the preset frequencies in the preset section to overwrite and save the station. Tapping on the preset will simply recall the saved frequency.

You can flick between Tapping the FM button on the bottom of the screen allows you to cycle between three different preset pages.

Holding down the 🔍 button will automatically cycle through detected radio stations and will save them as presets, filling out all three pages with found stations.

Simply tapping the button will just cycle through the stations giving you ample time to save them as a preset if you would like.

AM Radio



Auto tuning

Press the seek icon (◀ or ▶) on the screen to automatically seek to the next found station.

Manual tuning

Tap the ◀◀ or ▶▶ icon to increase / decrease the tuning frequency by one step at 0.05MHz increments for AM.

You can also drag the slider to quickly change the frequency to specified number.

You can also manually input a frequency using the keypad in the bottom right.

Once on a station you would like to save, simply tap and hold any of the preset frequencies in the preset section to overwrite and save the station. Tapping on the preset will simply recall the saved frequency.

You can flick between Tapping the AM button on the bottom of the screen allows you to cycle between two different preset pages.

Holding down the 🔍 button will automatically cycle through detected radio stations and will save them as presets, filling out all three pages with found stations.

Simply tapping the button will just cycle through the stations giving you ample time to save them as a preset if you would like.

DAB+ Radio

Signal Strength

Signal Strength of Current DAB+ Station

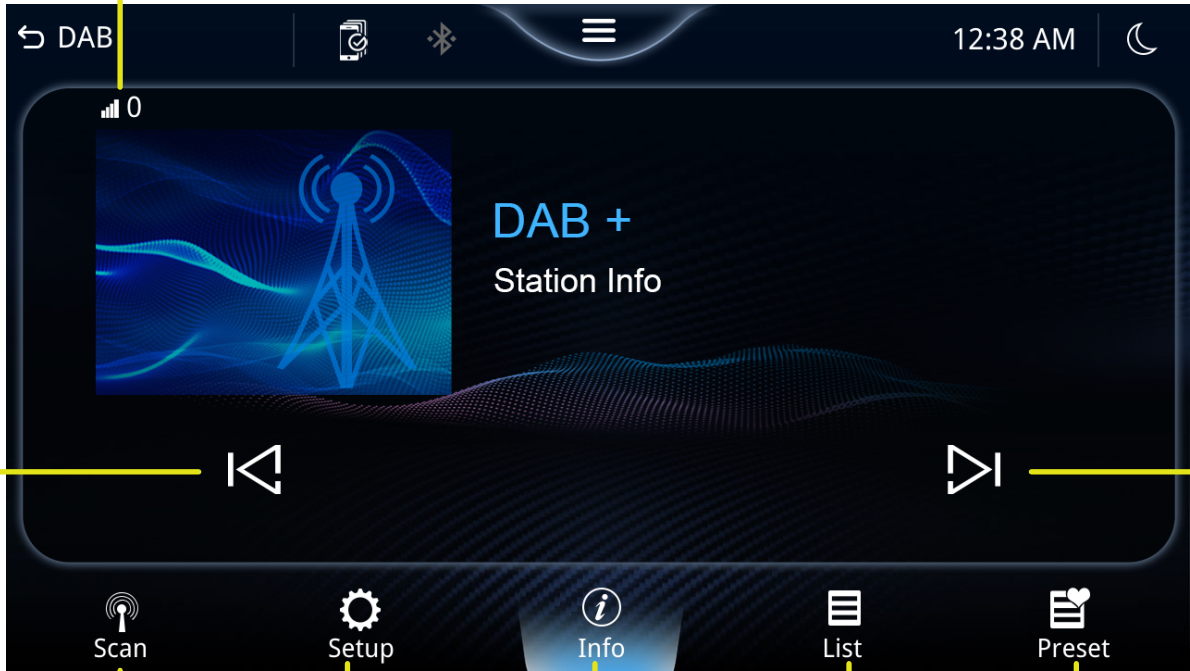

Previous Station
Switch to the previous station

Setup
Adjust DAB+ Settings

Info
View Track Information & Album Art

List
View DAB+ Stations

Next Station
Switch to the next station

Scan
Scan all DAB+ stations

Preset
View Saved DAB+ Presets

DAB+ Radio cont.....

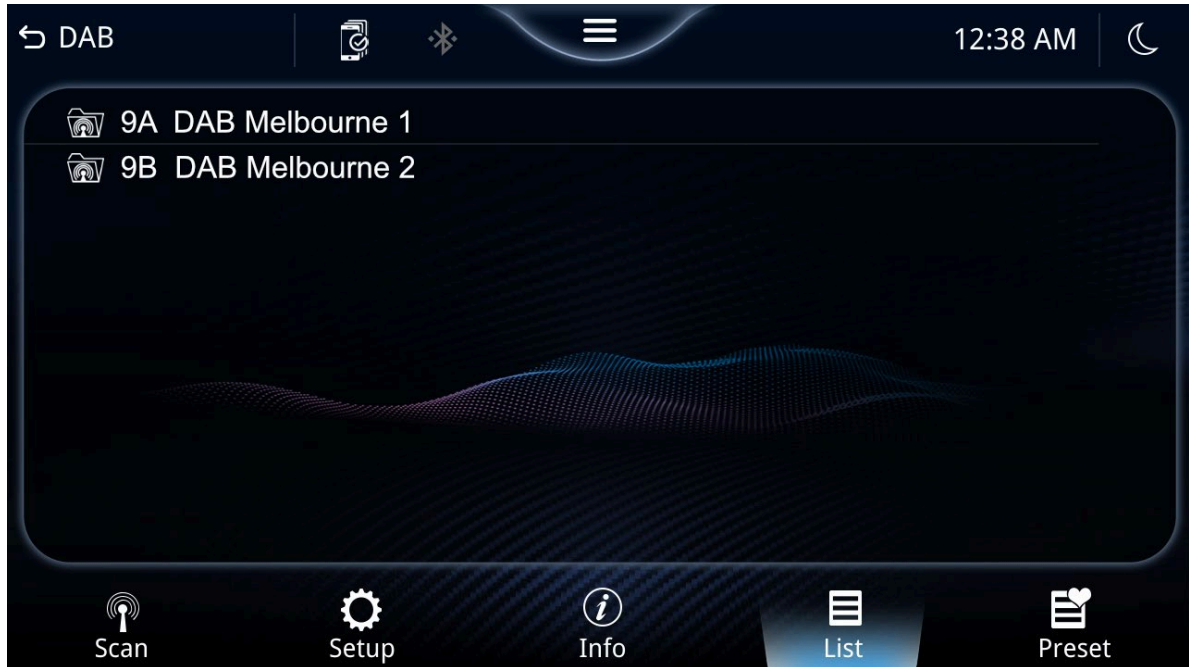

Folders

When DAB+ scans for stations, they will be listed in folders based off their detected frequency. Tapping on the folders will show the list of stations within that folder.

DAB+ Radio setup

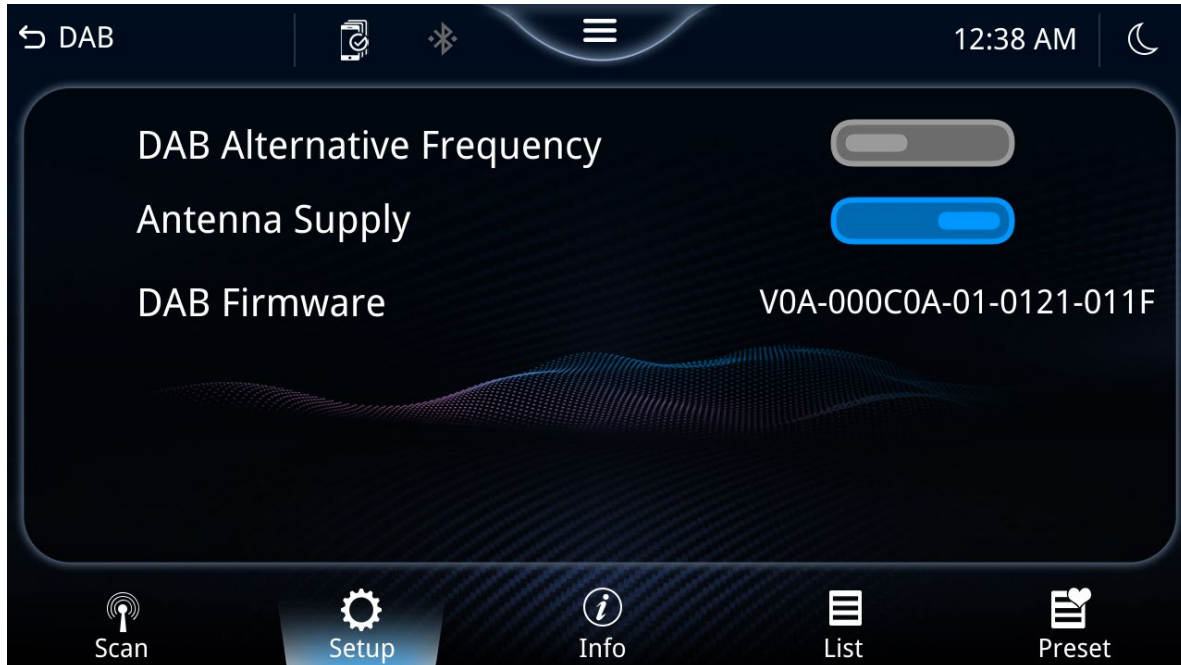

DAB Alternative Frequency

This will automatically alternate between neighbouring DAB frequencies in order to get the best signal possible.

NOTE: You may find that this will change to a frequency that is not intended due to signal range.

Antenna Supply

Boosts DAB antenna power. To be left ON for best signal possible.

DAB+ Preset

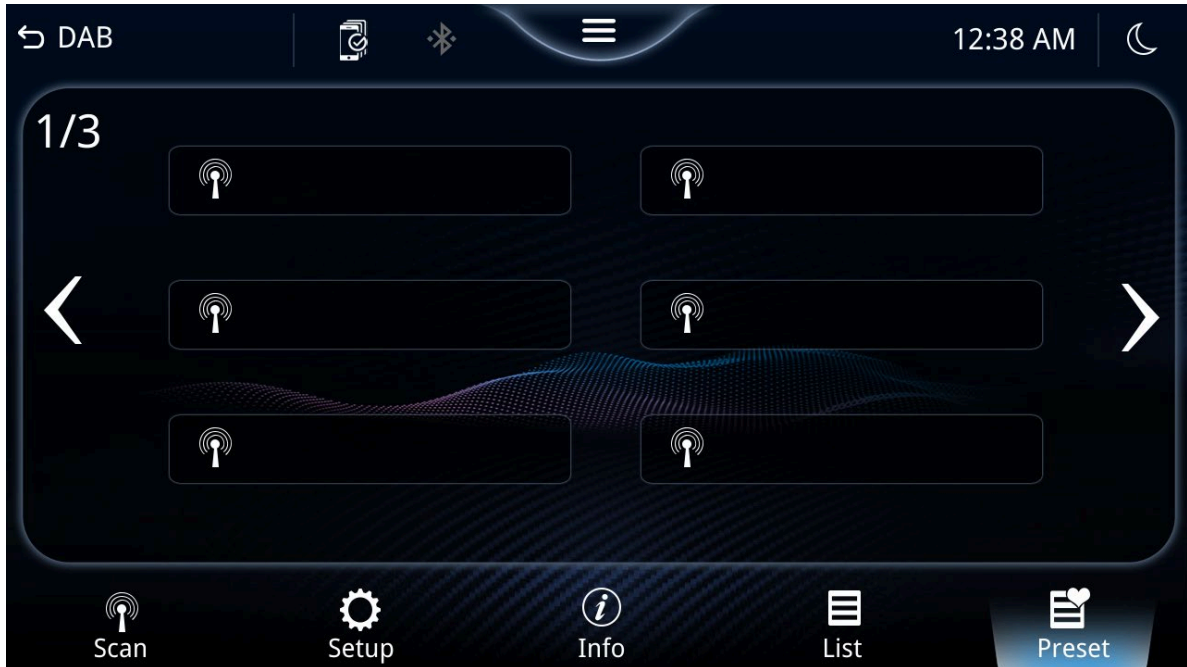

Here you can select and store saved presets for DAB radio. There are three pages of six giving a total of 18 presets that can be saved.

If you would like to save the current station as a preset, simply tap and hold on a preset location while on the preset tab. Once saved, the name of DAB station will appear. Simply press the saved preset in order to change to the saved DAB station.

Inclinometer

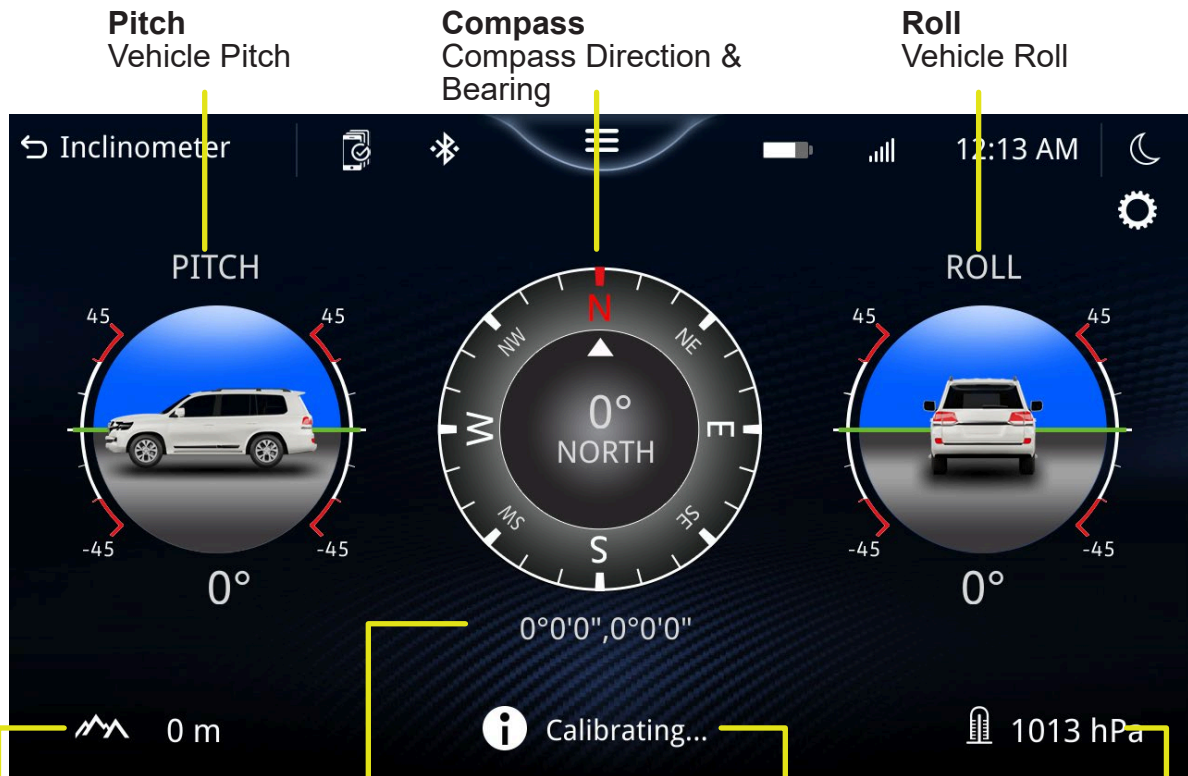

Altitude
Vehicles Altitude

GPS Coordinates
GPS Coordinates

Calibration
Calibrating Notification

Air Pressure
Vehicles Air Pressure

The inclinometer works by using the head units GPS and internal sensors to provide pitch, roll, bearing and GPS coordinates.

There are two forms of calibration for the inclinometer.

Automatic Calibration - Simply drive as you would normally and the inclinometer will automatically calibrate itself. This is normally enough for most situations but may have inaccuracies depending on GPS signal, location and area.

Manual Calibration (Page 15). Manually activate the calibration procedure and follow the steps for a more accurate calibration.

TIP: The colour of the cars on this page can be changed to suit your vehicles paint colour.

NOTE: Calibration will typically lose memory if power is disconnected or the car battery is flat and will require recalibration.

The 'Calibrating...' text may appear even after being calibrated meaning continually increasing the accuracy of inclinometer (The inclinometer is still working as intended).

* **Inclinometer requires GPS to be connected. Inclinometer relies strong on GPS signal to function correctly. GPS Coverage improves accuracy of measurements.**

Inclinometer - Settings

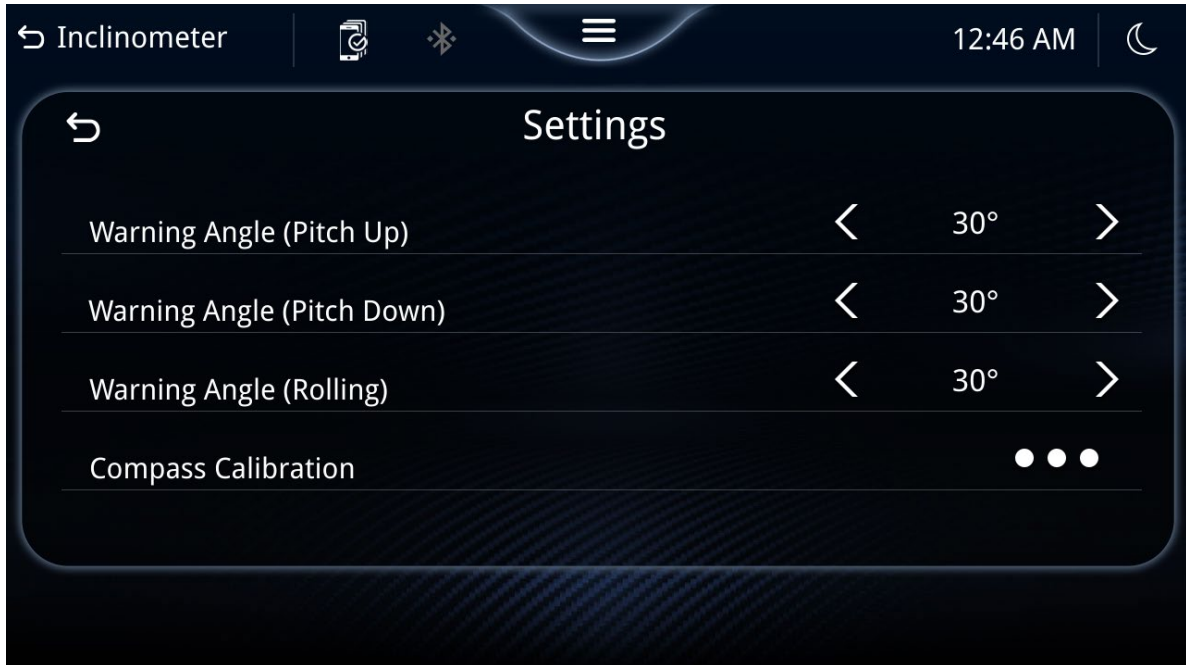

Warning Angles

Adjusting the angle of the Pitch & Roll will affect when the warning indicator will show in the inclinometer page. The adjustment of the following settings are indicated by the red line around the Pitch or Roll.

Once the angle specified has been reached then a red warning glow will appear around the relevant angle indicator.

Warning Angle (Pitch Up) - Increase or decrease the angle of warning notification.

Warning Angle (Pitch Down) - Increase or decrease the angle of warning notification.

Warning Angle (Rolling) - Increase or decrease the angle of warning notification.

Compass Calibration - This will allow you to manually calibrate the inclinometer function. You will have to follow the following directions in order for the most accurate results. These steps will also appear on screen to guide you.

"Step 1: Park/Drive in an open level area. Ensure you have good satellite."

This visibility by driving in an area that is unobstructed by the view of the sky.

Once you reach around 55% you will be required to do the following for the second step.

"Step 2: Repeat these actions in any order: park, drive(40km/h+), and turn."

This requires you to park, drive over 40km/h and do a left or right turn.

Once 100% has been reached, the manual calibration has been completed successfully.

Trip Information

Average Speed

Current Trip Time



Average Fuel Consumption

Current Fuel Consumption

Vehicle Range

Trip Info page will display your range, average fuel consumption, current fuel consumption, average speed & current trip time.

The blue bar is tied to the current fuel consumption and the green bar is tied to the average fuel consumption.

If you would like to reset the statistics of this page, please reset them via the MFD as instructed in your vehicles manual.

TIP: The colour of the car in the centre can be changed to suit your vehicles paint colour. You can find out how to do so on **(Page 30)**.

USB Playback

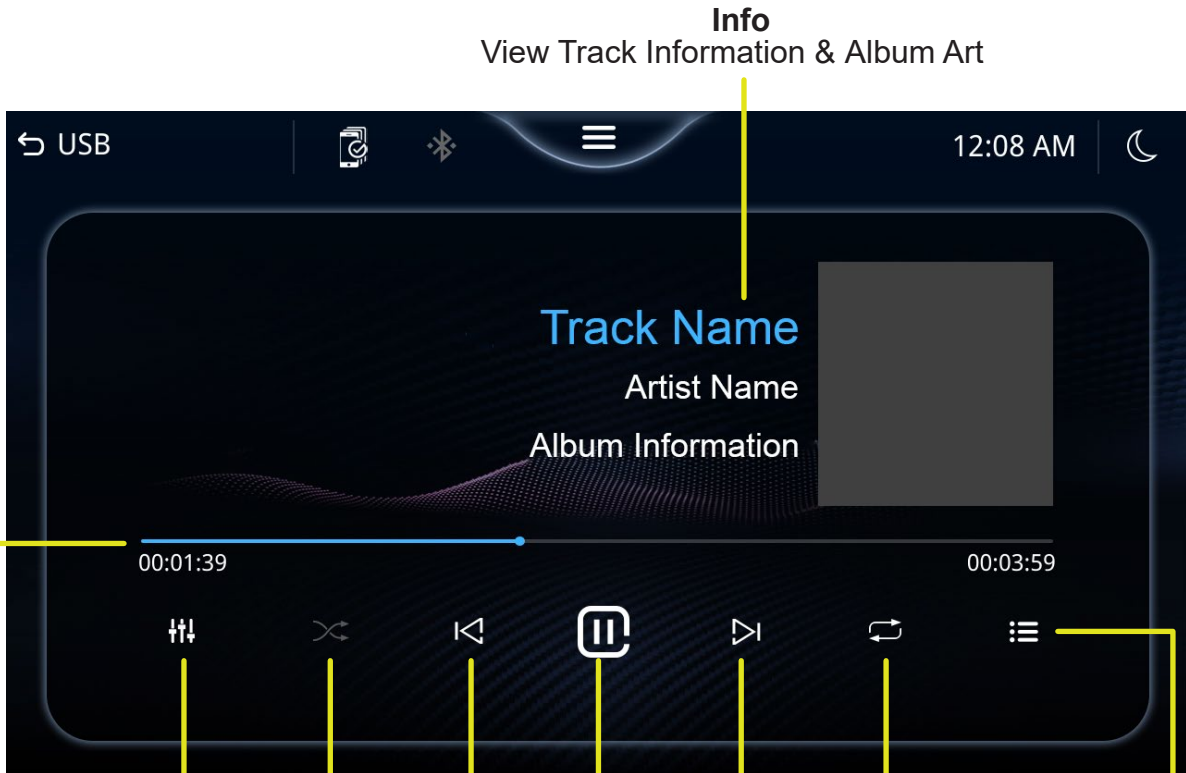

Info
View Track Information & Album Art

Track Seek
Tap and drag to adjust music

Shuffle
Cycle Between Different Shuffle Modes

Play/Pause

Loop Track
Cycle Between Different Loop Modes

Audio/Video List
Display Contents of USB Files

Equaliser
Quickly navigate to Equaliser

Previous Track

Next Track

Shuffle

Shuffle Off - Audio/Video will play in order of list for all audio/video files.

Shuffle On - Audio/Video will play in a random order.

Shuffle (F) - Audio/Video with it will play all the music inside this folder by random.

Loop

Loop Off - The Audio/Video will stop after playing all the audio/video files.

Loop 1 - Current Audio/Video will repeat it will repeat.

Loop F - Will loop current Video/Audio folder.

USB Playback

Audio Tab
Display Audio
Files on USB

Folder Up
Return from a
Folder

Current Tab
Shows Current
Tab Name

Search
Search Audio/Video
Files

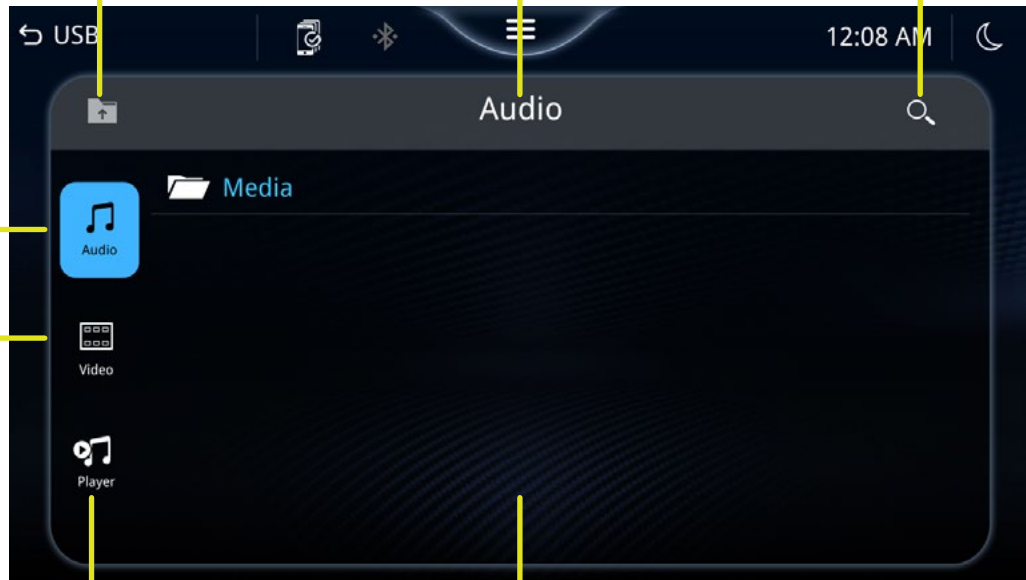

Video Tab
Display Video
Files on USB

Player
Display the Player

Media List
Lists Audio/Video
& Folders

This will display all the video and audio files stored on your USB drive. They are divided into two tabs, one for audio and one for video. If you have folders on your USB drive they will appear as folders on this list. Clicking on a media file will automatically begin playing it.

Compatible video files include: Xvid (MPEG-4) & MP4.

Compatible Audio files include: MP3, AAC & FLAC.

Watching videos while driving is dangerous, as it can distract the driver from the road, potentially leading to an accident. Videos will not play & will show a warning while the handbrake is disengaged.

Compatible USB required. Max storage is 32GB and requires to be formatted in FAT32.

Devices Connect

Touch the  icon to access the connected devices screen.

This screen displays paired devices and allows the user to turn Android Auto/Apple CarPlay or other Bluetooth features on or off. (If applicable to the device)

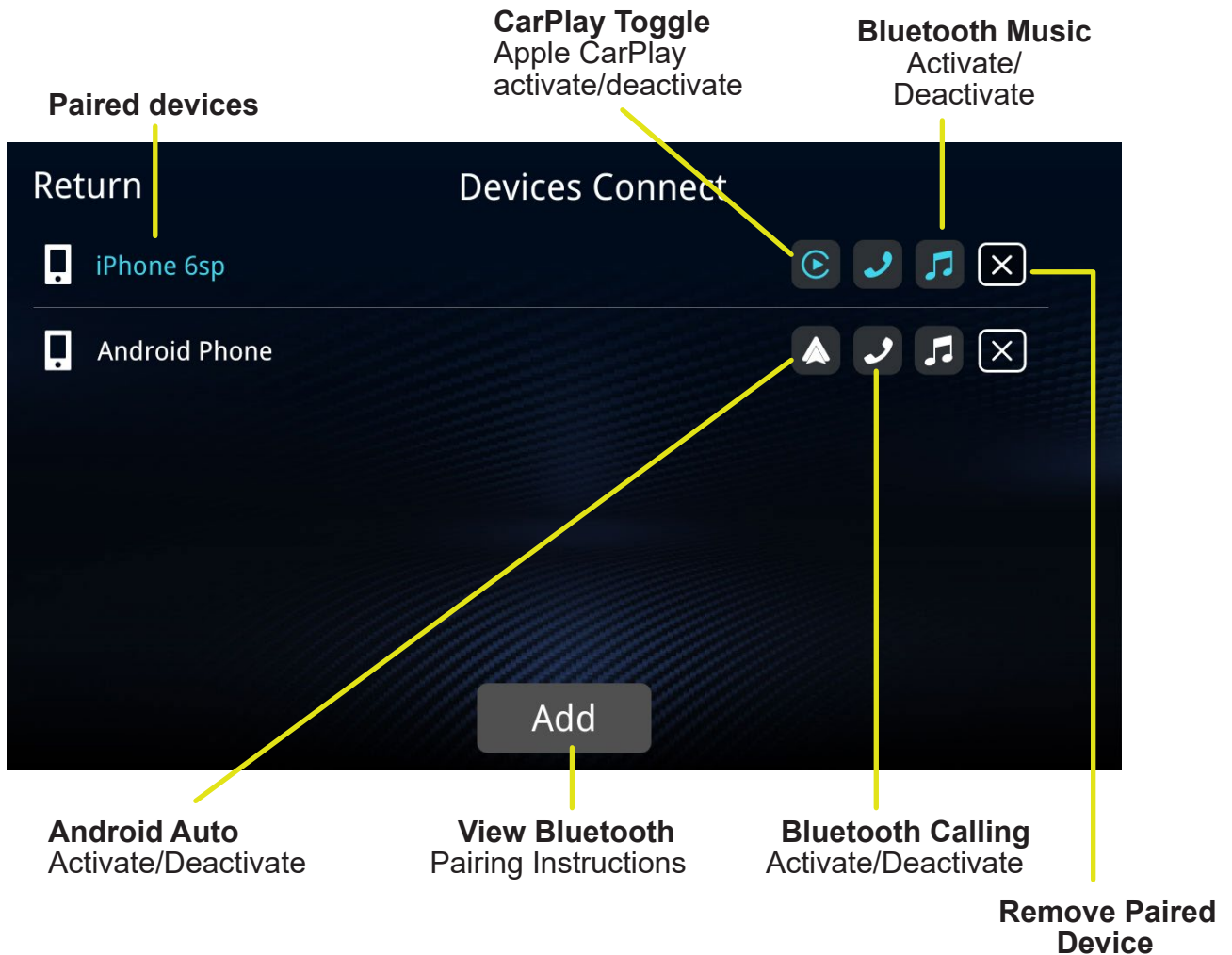

NOTE: Only one device can be active at any given time. The first paired device will take priority and connect first regardless of the last paired device.

If you would like to switch over the active connected device with another paired device, first ensure that there are no icons highlighted blue on the currently connected device. Simply tap the icons to toggle the connection state. Once all the icons are white for the first connected device, you can then toggle the music and phone icons of the second device. Once the phone connection has been established the head unit should automatically start Android Auto/Apple Carplay.

Bluetooth Calling and Bluetooth Music is deactivated on this screen when using Apple Car Play however Bluetooth Calling and Music work through Apple Car Play as intended.

Android Auto requires Bluetooth Calling and Bluetooth Music to be connected and activated for Android Auto to function correctly.

Settings - General



Date and Time - Select to adjust the time & date (Disabled if Auto Adjust by GPS is enabled)

AM/PM - Change time from AM to PM (Disabled if Auto Adjust by GPS is enabled)

Time Format - Choose clock mode 12H/24H

Time Zone - Adjust the time zone to for your region

Auto Adjust by GPS - Use the GPS to automatically find time & date. (Requires GPS Signal)

Daylight Savings Time - Adds +1 hour to clock for daylight savings timezones

Beep - Activation / Deactivation of touch screen beep

CarPlay/Android Auto Right Hand Drive - Changes indicator bar to left or right of display

Show CarPlay/Android Auto Once Connected - Will automatically display Android Auto/Apple CarPlay screen when connected

BT/Android Auto Mic Gain - Adjust the Mic Gain for calls when connected via Android Auto or via the inbuilt Bluetooth function.

Apple CarPlay Mic Gain - Adjust the Mic Gain for calls when connected via Apple CarPlay

Settings - Audio



Volume Control - Adjust the volume of each audio source

Equaliser - Setup & adjust 16 band EQ and adjust Balance (Balance disabled if Factory Amplifier is enabled)

Time Alignment - Adjust time delay of each speaker (Disabled if Factory Amplifier is enabled)

Filter - Adjust the crossover of the Subwoofer, Front & Rear Speakers (Front & Rear Filter disabled if Factory Amplifier is enabled)

Loudness - Extra boost in audio loudness

Subwoofer - Turn the subwoofer on or off (Requires Subwoofer)

Subwoofer Gain - Increase or decrease the gain of a subwoofer (Requires Subwoofer)

Reverse Volume - Controls the audio volume when the vehicle is in reverse

Automatic Sound Leveliser - Automatically adjust the audio volume based on the GPS speed of the vehicle. There are three settings to choose from that adjust the volume increments for speed milestones above 60km/h to 100km/h.

NOTE: GPS connection is required and function may not be active until GPS connection has been established. The longer you drive, the more accurate the sensor will become.

Settings - Audio - Volume Control

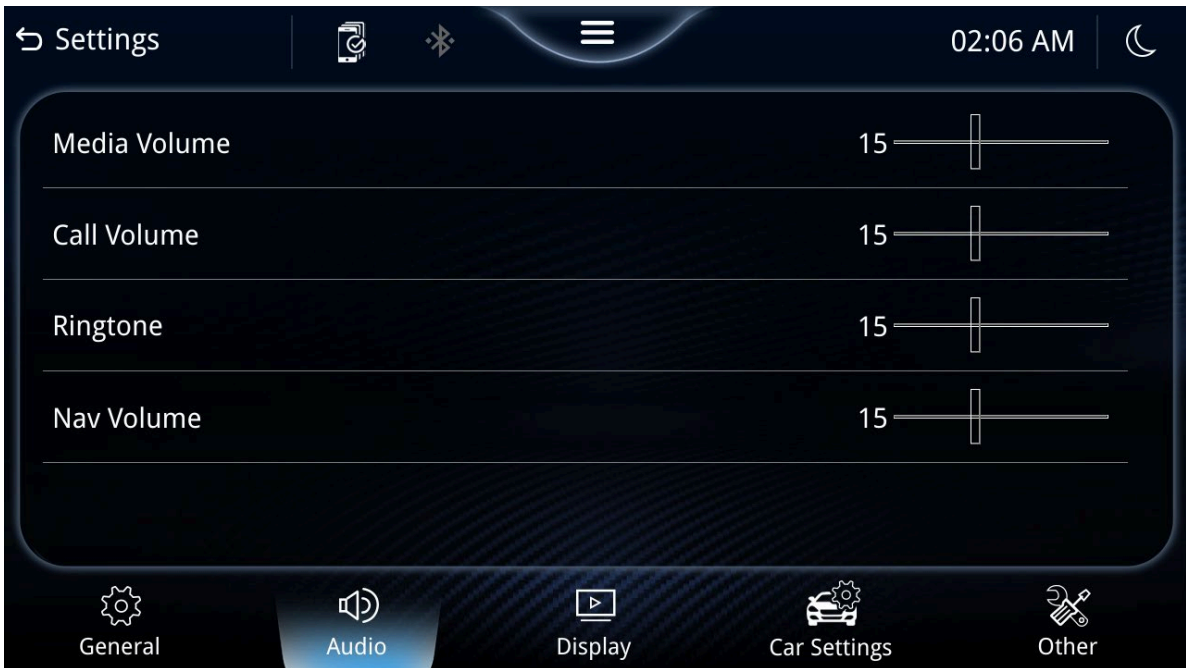

Volume Control allows you to adjust the volume of each audio source.

Simply drag the slider towards the right to increase the volume or left to decrease the volume.

Media Volume: Music Volume such as from Android Auto or Apple CarPlay

Call Volume: This will adjust the audio volume during a call

Ringtone: Ringtone Volume of connected mobile device when receiving a call.

Nav Volume: Navigation volume of audio prompts whilst navigating.

NOTE: You can still adjust the audio on the fly whilst an audio source is playing, for example if you are on a call, adjusting the volume will adjust the Call Volume.

Settings - Audio - Equaliser

Q Factor Adjustment

Tap to change the Q Factor of Band

Band Adjustment

Drag the sliders to adjust the gain for each Band

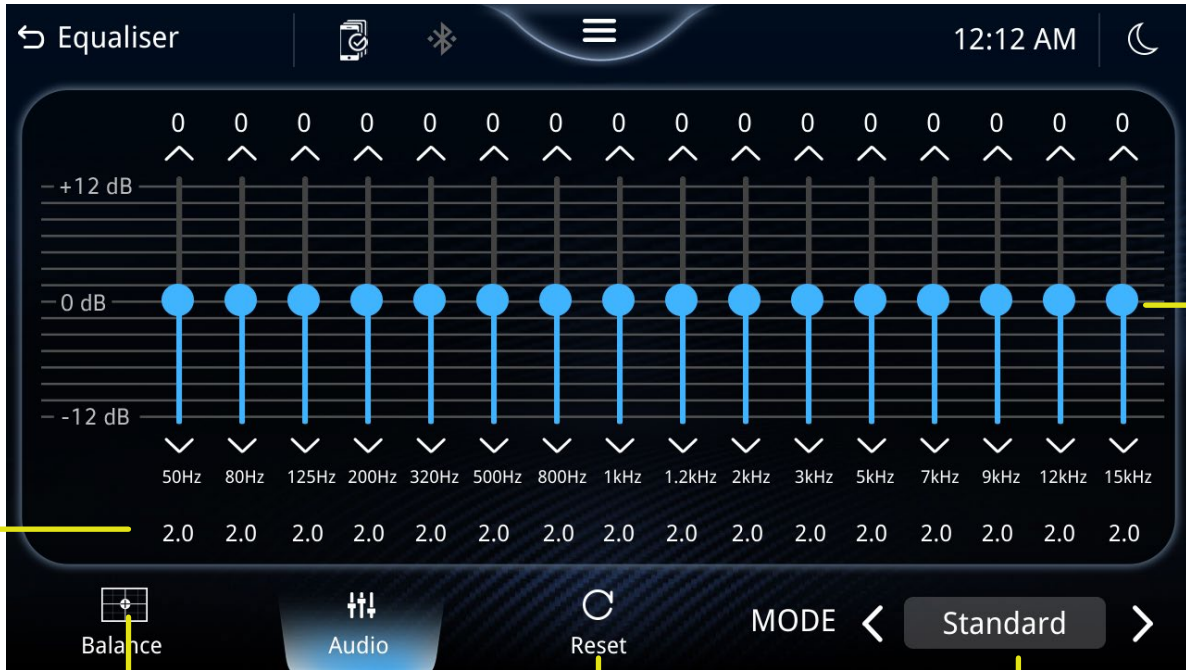

Balance

Switch to Balance Tab*

Reset

Reset EQ & Balance to default

Presets

Cycle between different preset

Selecting Equaliser from the Audio Menu Bar will bring up the 16 band graphic equaliser and presets. There are a 7 factory default presets with 3 custom presets to switch between.

Frequency adjustments can be made by touching and sliding the sliders up/down. You can also adjust the Q-Factor by tapping the numbers underneath the band frequency. That will bring up a text box to change and apply the new Q-Factor Value.

Making adjustments are automatically applied.

NOTE: If you are on any of the default presets and begin to make changes to the EQ then it will automatically switch over to the custom preset and overwrite any existing changes in the custom preset.

You can also adjust the balance of the vehicle by switching to the Balance Tab (Page 24)

* Adjusting Balance is disabled when Factory Amplifier is enabled. Please use the Factory Car Audio Settings to adjust Balance. (Page 30)

Settings - Audio - Balance

Adjust Balance
Drag the cross hair to adjust Fader and Balance

Balance Presets
Cycle between different balance presets

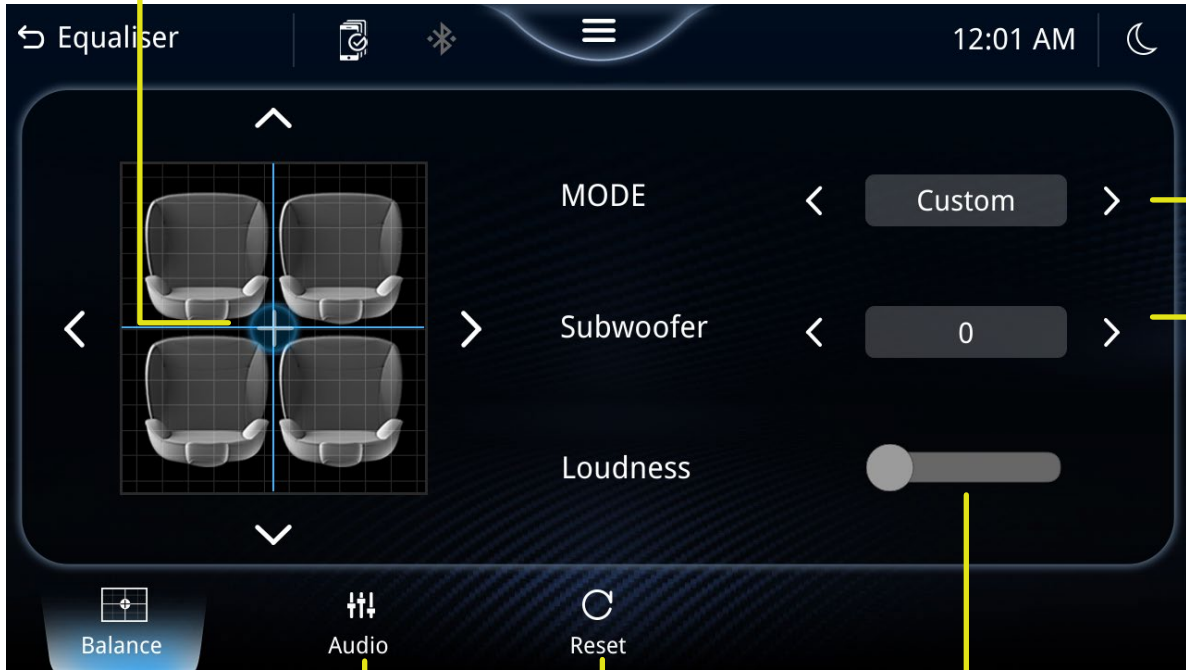

Audio
Switch to EQ Tab

Reset
Reset EQ & Balance to Default

Loudness
Toggle Audio Loudness

Subwoofer
Adjust Subwoofer Volume

NOTE: if you are on any of the default presets and begin to make changes to the EQ then it will automatically switch over to the custom preset and overwrite any existing changes in the custom preset.

* Adjusting Balance is disabled when Factory Amplifier is enabled. Please use the Factory Car Audio Settings to adjust Balance/Fade. (Page 30)

Settings - Audio - Time Alignment

Time Alignment
Adjust time alignment

The screenshot shows the 'Time Alignment' settings interface. At the top, it says 'Time Alignment' and 'Adjust time alignment'. The main area features a central diagram of a car's interior with four seats. Surrounding this diagram are controls for 'Front Left', 'Rear Left', 'Front Right', and 'Rear Right', each with a '0ms' value and left/right arrows. Below the seats is a 'Subwoofer' control with a '0ms' value and arrows. At the bottom left, there is a 'Unit' toggle switch between 'ms' and 'cm'. At the bottom center, there are four speaker icons labeled 'DEFAULT', 'PRESET 1', 'PRESET 2', and 'PRESET 3'. At the bottom right, there is a 'RESET' button. Yellow callout lines connect these elements to descriptive text below the screen:

- Units**
Change unit of measurement
- Presets**
Change between Presets
- Reset**
Reset Time Alignment to Default

In order to begin making adjustments to time delay, you will have to switch to one of the presets. Once selected, you will now be able to adjust the time delay by using the arrows next to each speaker and subwoofer. If you would like to use cm's as a form of measurement, then using the Unit toggle on the left corner.

Changes are applied automatically.

*** Adjusting Time Alignment is disabled when Factory Amplifier is enabled.**

Settings - Audio - Filter

Crossover Type

Cycle Between crossover types

Crossover Method

Cycle between crossover types

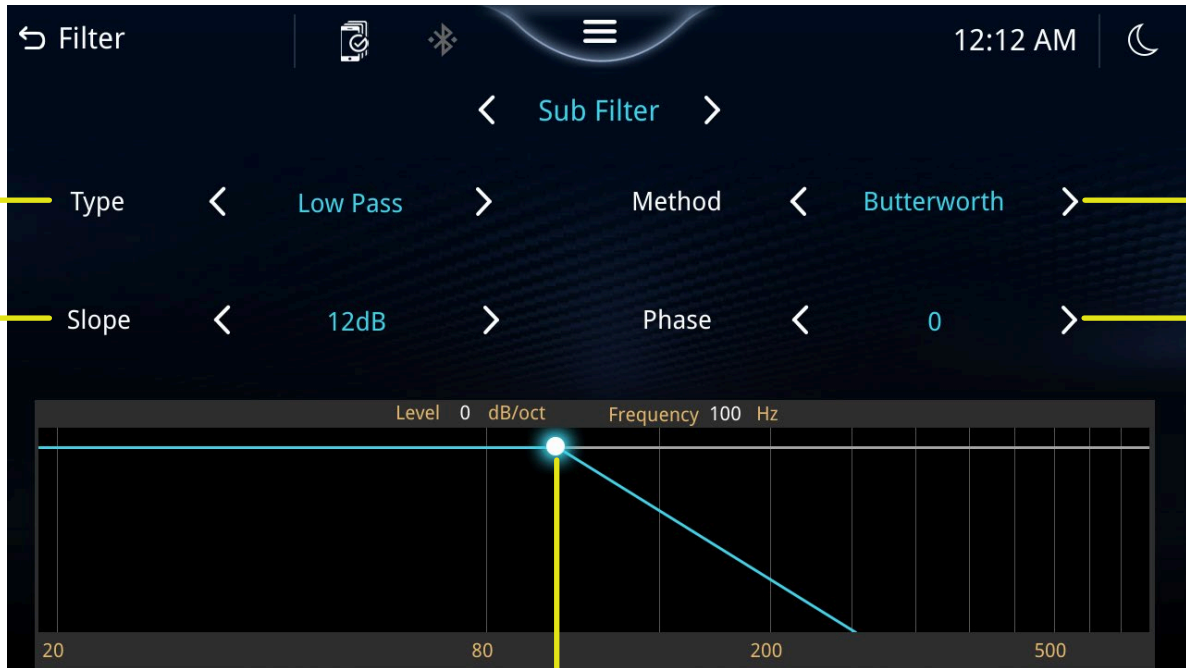

Slope

Adjust crossover slope

Crossover Adjustment

Change the frequency & dB level

Phase

Change phase (Sub Filter Only)

On this page you can adjust the crossover of the Subwoofer (if equipped), Front Speakers* & Rear Speakers*.

Type - Change the crossover type between Low Pass, High Pass & Through

Method - Change the crossover method between Butterworth & Linkwitz

Slope - Adjust the slope of the crossover between 12/24dB (Linkwitz) or 6/12/18/24dB (Butterworth)

Phase - Switch the phase between 0° & 180° (Subwoofer only)

To adjust the crossover frequency & dB level, tap and drag the blue circle in the frequency box.

Changes are applied automatically.

* Adjusting Front & Rear Speaker Filter is disabled when Factory Amplifier is enabled.

Settings - Display

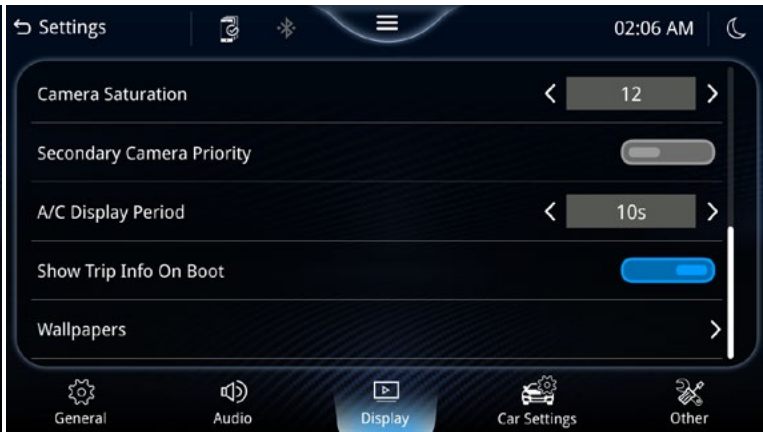
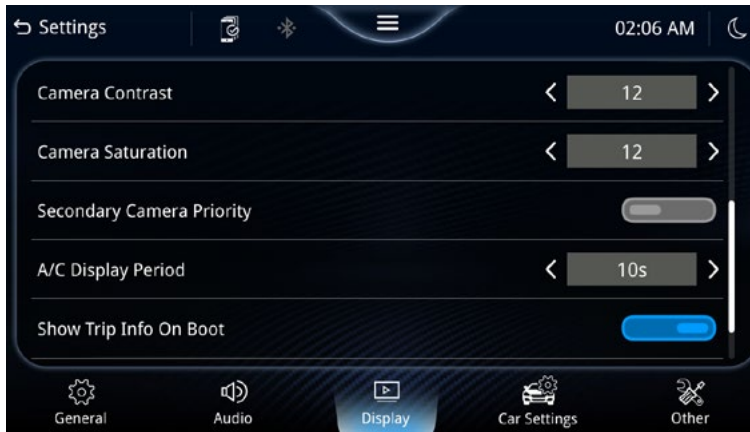
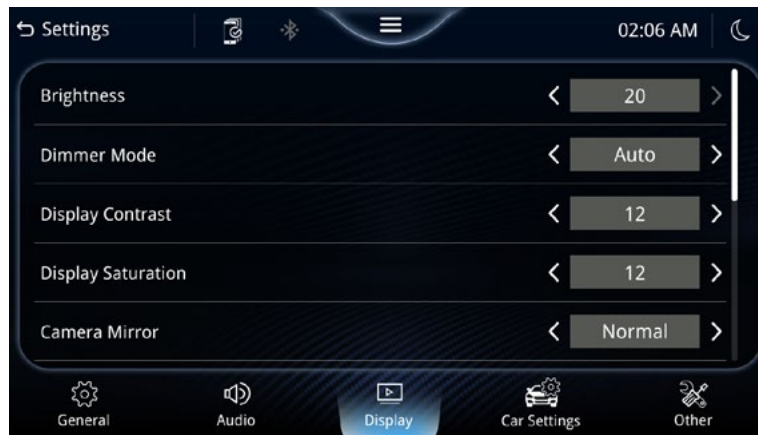

Brightness - Adjust the brightness of the head unit.

Dimmer Mode - Auto: Automatically dims the display brightness when your vehicle's headlights are on
 Day: Display Brightness is always set to brightness specified regardless of headlights
 Night: Display Brightness is always set to brightness specified regardless of headlights

Display Contrast - Adjust the contrast of the display

Display Saturation - Adjust the saturation of the display

Camera Mirror -

Normal: No Camera Mirror Adjustment for the rear camera

Horizontal: Flips the rear camera horizontally

Vertical: Flips the rear camera vertically

Horizontal + Vertical: Flips the rear camera horizontally & vertically

Camera Contrast - Adjust the contrast of the camera

Camera Saturation - Adjust the saturation of the camera

Secondary Camera Priority - When enabled, the vehicle will show the second camera (if connected) when the vehicle is in reverse.

A/C Display Period - Adjust the timeout period for the climate screen when no button has been pressed

Show Trip Info On Boot - When the head unit is powered, the Trip Info screen will show for 5 seconds before disappearing. (This may interrupt your current source)

Wallpapers - Choose from a selection of wallpapers that will be present across the user interface

Settings - Car Settings

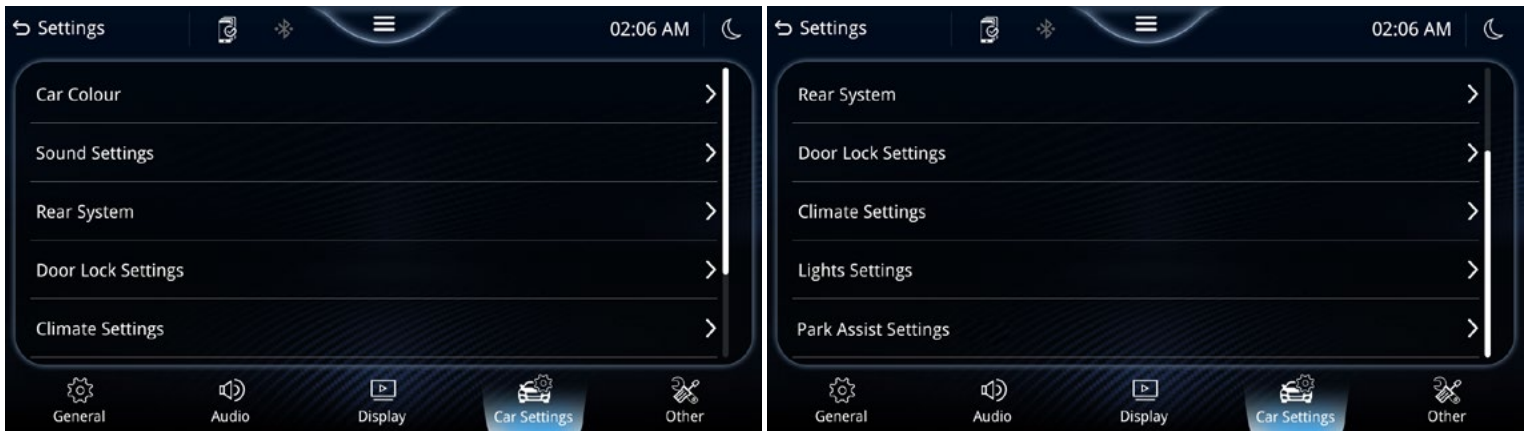

Car Colour - Here you can set the colour of your vehicle. The colours are based off the factory paints that were available for purchase with the vehicle. See **(Page 30)** for more details

Sound Setting - Adjust the built-in Amplifier settings.

Rear System - Adjust the rear entertainment system in the vehicle (Applicable vehicles only)

Door Lock Settings - Adjust the factory Door Lock Settings

Climate Settings - Adjust the factory Climate Settings

Lights Settings - Adjust the factory Light Settings

Park Assist Settings - Adjust the factory Park Assist Settings

Settings - Car Settings - Car Colour

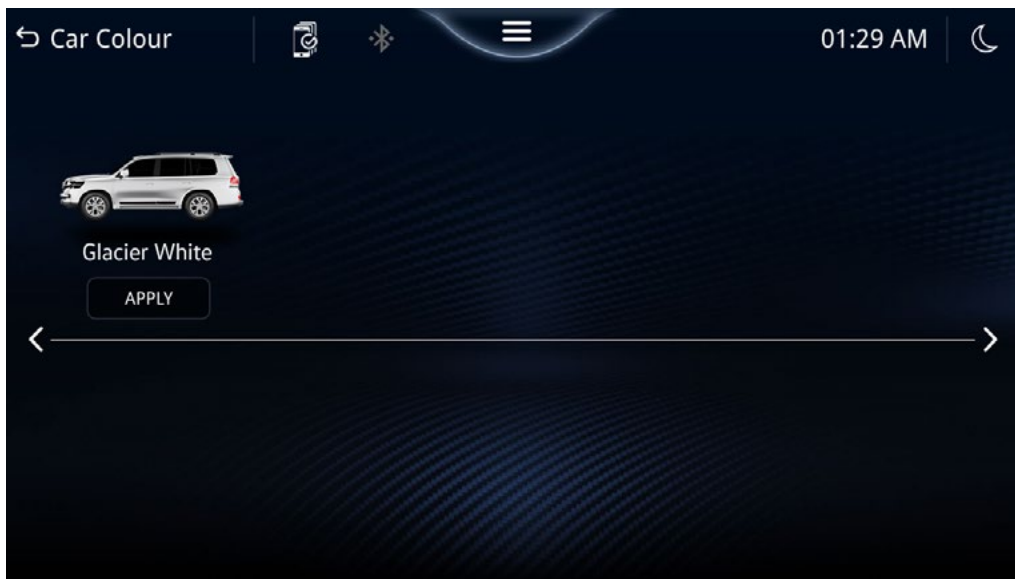
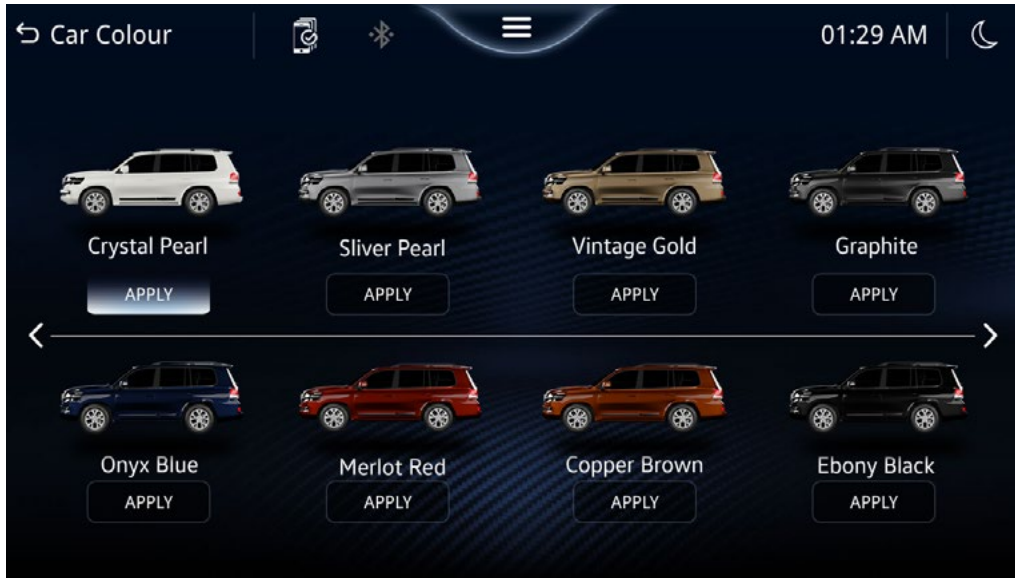

Select the colour that matches the paint colour of your vehicle. This will change the appearance of vehicles through the head unit including the Inclinator, Trip Info & Park Assist screens.

Pressing the arrow on the side will navigate to the next page.

Settings - Car Settings - Sound Settings



Here you will be able to change the Factory Amplifier Audio Settings in the vehicle. Due to the nature of this vehicle and head unit, there are two sets of audio 'layers' in this vehicle, the Factory Amplifier and the head unit's audio processing. It may be easier to think of the Factory Amp as a 'pre-gain' and the head unit's audio as a 'post-gain'. We have set the 'pre-gain' on the factory amplifier to 50 out of 63 and have the main volume buttons control the 'post-gain' volume. This allows for volume of each source to be adjusted when heard or through the Volume Control screen.

Do note that the volume and other audio adjustments of the amplifier will carry over from the factory unit to the AMUTO53. You may want to double check and readjust settings to suit your needs.

Use Factory Amplifier - When turned on, the vehicle's in-built amplifier will be utilised, including Factory Amplifier Settings.

NOTE: Time Alignment, Balance in Audio Settings & Front/Rear Filter are not accessible when Factory Amplifier is turned on. If you would like edit Balance/Fade, do so from the Car Setting - Sound Settings menu.

When turned off, control of the factory amplifier settings will be disabled and optimise audio for the in-built amplifier or RCA preouts.

NOTE: If you are using the ISO audio connector to run your speakers or using the RCA Preouts, and not using the inbuilt amplifier, then turn this feature off. If you are utilising the vehicles factory amplifier then have this feature on.

Factory Amplifier Volume - Adjusts the Factory Amplifier 'pre-gain' volume.

Factory Amplifier Fade - Adjust the audio fade from front to rear of vehicle

Factory Amplifier Balance - Adjust audio from left to right of vehicle

Factory Amplifier Bass - Adjust Amplifier 'pre-gain' Bass

Factory Amplifier Treble - Adjust Amplifier 'pre-gain' Treble

Factory Amplifier Middle - Adjust Amplifier 'pre-gain' Middle

Settings - Car Settings - Rear System

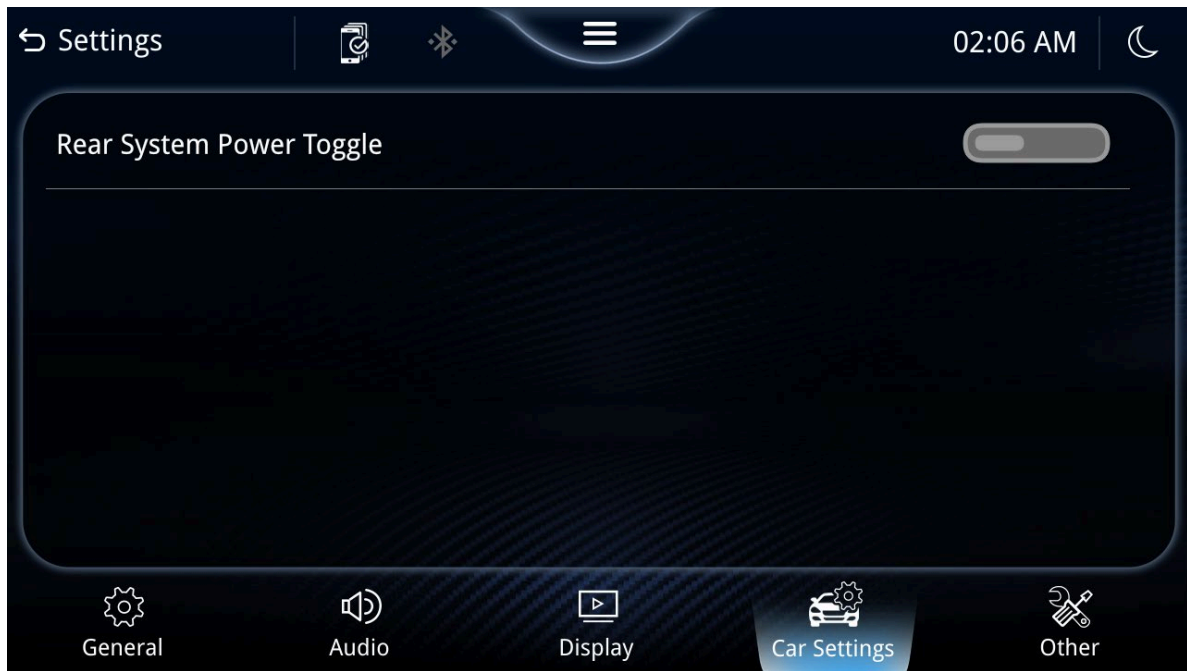

The Rear System Power Toggle allows you to remotely turn the rear entertainment systems on or off via the head unit. This is a toggle button and will simple toggle power regardless of current state.

NOTE: This feature is only applicable to vehicles with rear entertainment systems such as Sahara models.

Settings - Car Settings - Door Lock Settings

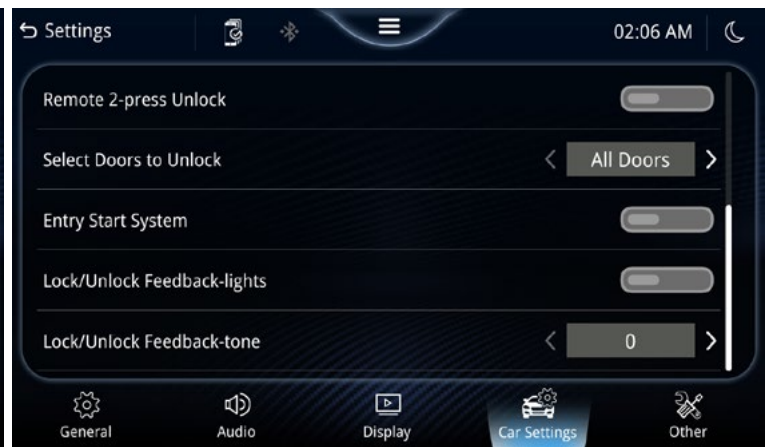
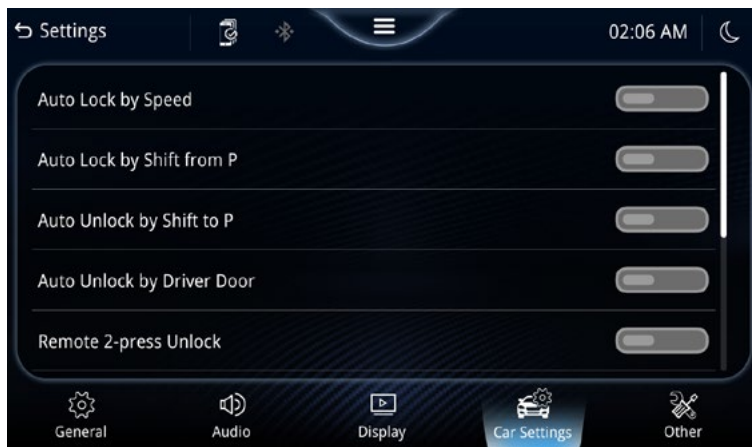

Adjust the Door Related Vehicle Car Settings on this page.

NOTE: These settings are matching that of the original vehicle and if you would like more information on what these settings do, check the vehicle manual.

Auto Lock by Speed - All the doors are locked when the vehicle speed is approximately 20 km/h or higher.

Auto Lock by Shift from P - Automatically lock the doors when shifting from Park.

Auto Unlock by Shift to P - Automatically unlock the doors by putting the vehicle in Park.

Auto Unlock by Driver Door - All the doors are unlocked when the driver's door is opened within approximately 45 seconds after turning the engine switch off.

Remote 2-press Unlock - Driver's door unlocked in one step, all doors unlocked in two steps

Select Doors to Unlock - Drivers door - Key fob unlock will only unlock drivers door .

All the doors - Key fob unlock will unlock all the doors.

Entry Start System - This feature disables the remote start function and will require manual unlocking & starting. Refer to vehicles manual for more information.

Lock/Unlock Feedback-lights - Enable or Disable the Vehicle blinking its warning lights when locking or unlocking the vehicle.

Lock/Unlock Feedback-tone - Adjust the volume of the feedback sound of the vehicle when locking or unlocking the car.

Settings - Car Settings - Climate Settings



Auto Seat Temp. FR L - Adjusts sensitivity of the passengers seat when on Auto to engage sooner or later depending on setting. (Sahara variant only)

Auto Seat Temp. FR R - Adjusts sensitivity of the drivers seat when on Auto to engage sooner or later depending on setting. (Sahara variant only)

Auto A/C Mode - Function to turn the A/C on automatically by pressing the AUTO button when the blower is on and the A/C is off.

Efficient Ventilation Mode - Function to change the mode automatically to re-circulation air mode when turning the A/C on to cool the cabin quickly.

Settings - Car Settings - Light Settings

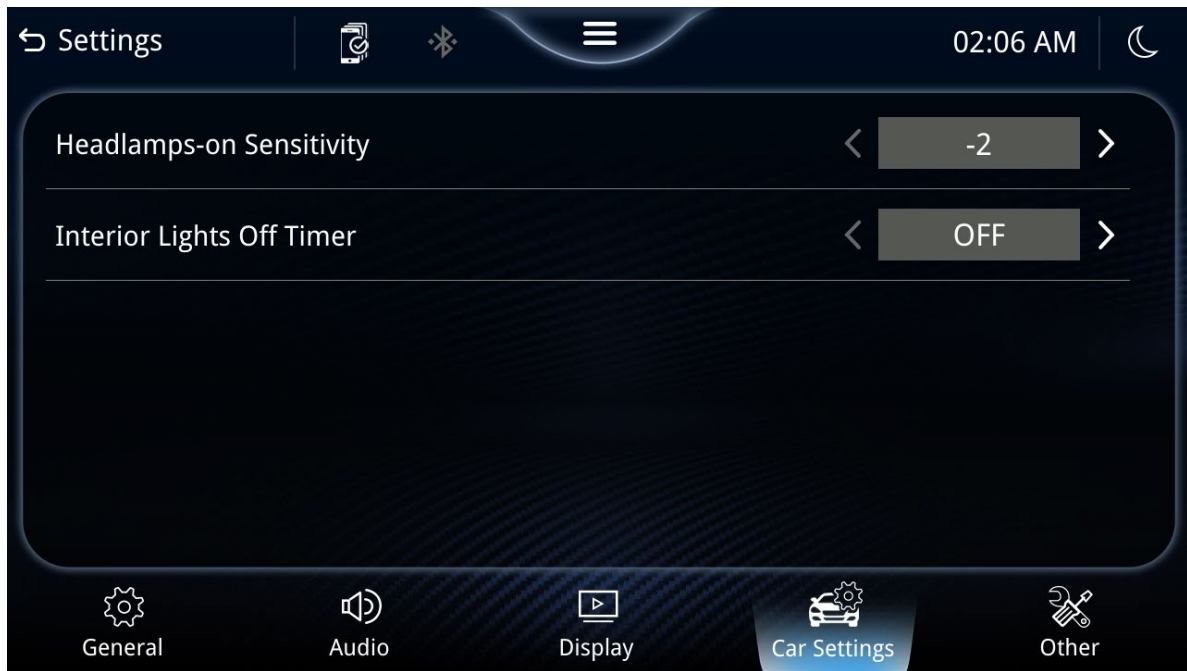

Headlamps-on Sensitivity - Adjust the sensitivity of headlamps to automatically turn on under sooner darker lighting conditions.

Interior Lights Off Timer - Time period before the interior lights turn off.

Settings - Car Settings - Park Assist Settings

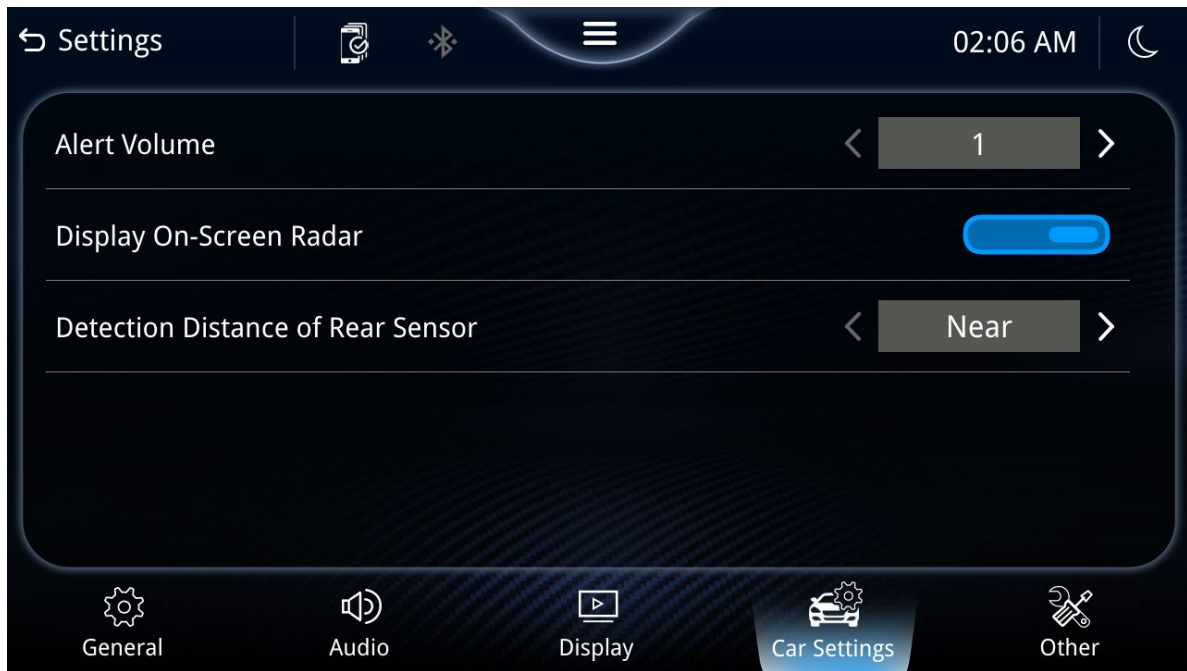

Alert Volume - Adjust the loudness of the alert volume.

Display On-Screen Radar - Enable the display of the on-screen radar when the front sensors are activated at low speeds. See **(Page 38)**

Detection Distance of Rear Sensor - Detection distance of the rear sensor.

Settings - Other

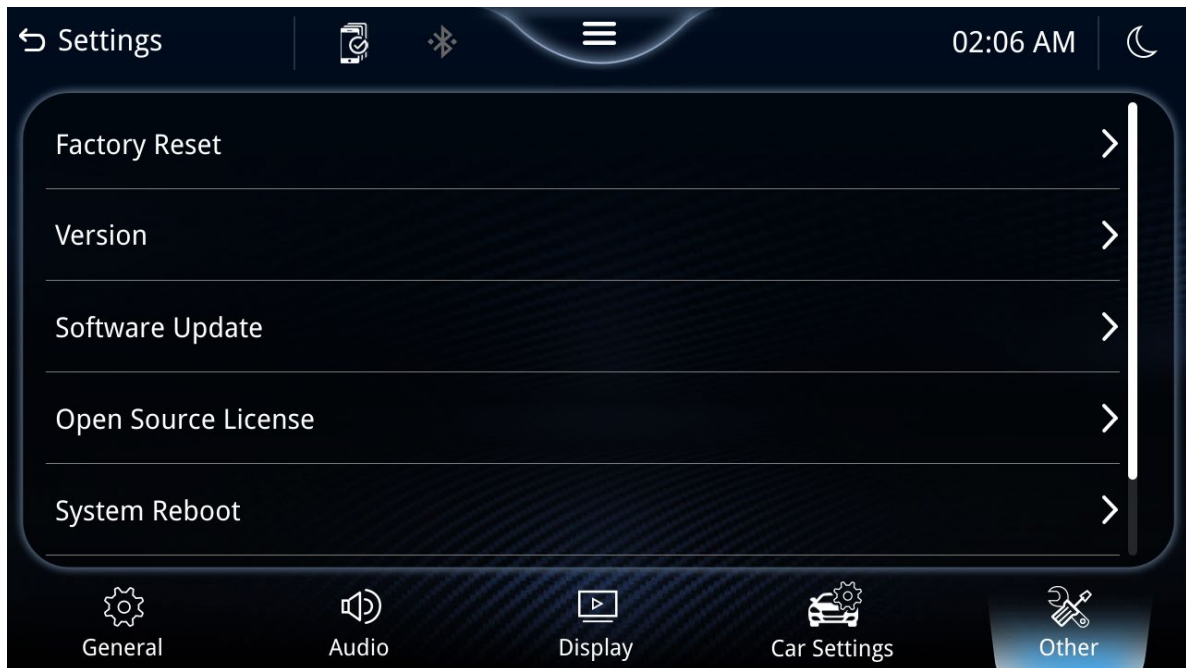

Factory Reset- Reset the head unit settings to factory defaults.

Version - View the software version number.

Software Update - Activate software update procedure. Requires USB with relevant update firmware.

Open Source License - Displays license information.

System Reboot - Manually Reboot the system without having to restart the vehicle.

DR Sensor Update - Update inbuilt sensor information. Requires USB with relevant update firmware.

Park Assist Screen

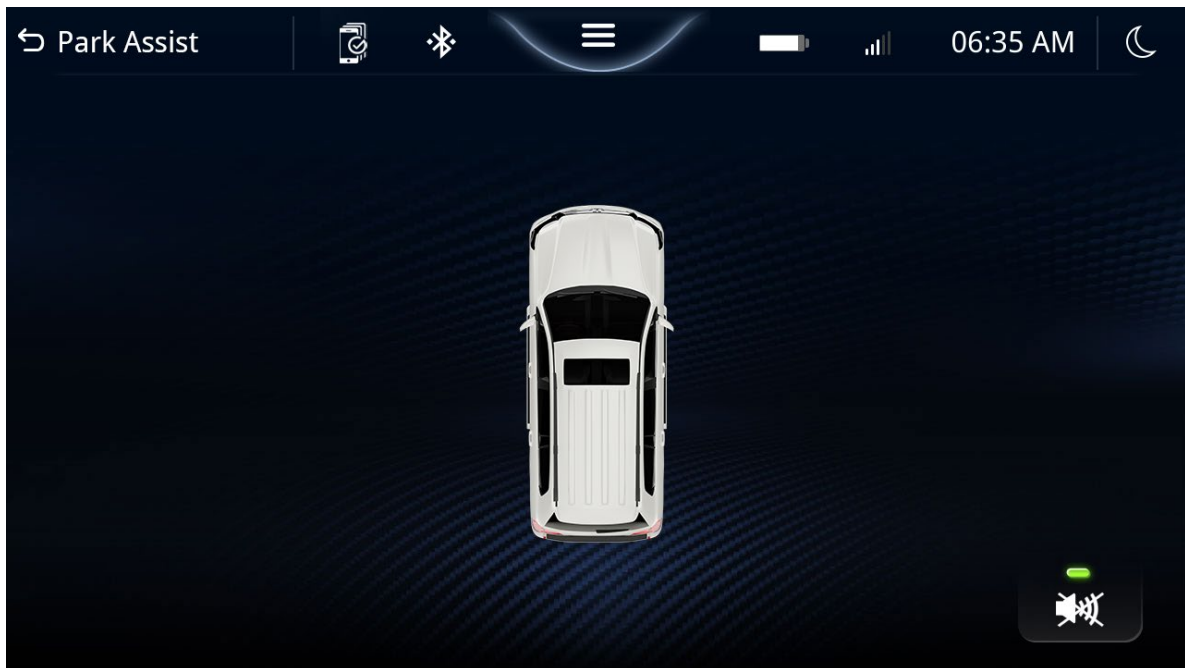

If the 'Display On-Screen Radar' setting is enabled, then this screen will appear whenever one of the front sensors detect an object under the following conditions.

- The engine switch is turned to IGNITION ON mode.
- The shift lever is in a position other than P.
- The vehicle speed is less than approximately 10 km/h.

In the bottom right corner is a audio mute button if you would like to mute the alert sound when an object has been detected.

TIP: The colour of the car in the centre can be changed to suit your vehicles paint colour. You can find out how to do so on **(Page 30)**.

Wired & Wireless CarPlay Operation

NOTE: We recommended that the wired connection method be used for new devices.



Wired connection

1. Turn on Bluetooth and WiFi on your compatible device
2. Connect an Apple CarPlay compatible device to this unit via USB1 (CP/AA/USB Media)
3. A pair message and a pairing request code may appear on your compatible device and head unit. Click allow to accept
4. An 'Allow CarPlay with AMUTO53-XXXX while phone is locked' message may appear on your device. Click allow to accept
5. Click to enable wireless CarPlay or use USB only option
6. Once connection is enabled for wireless CarPlay, connection via the USB connection is no longer required and wireless connection will be automatic
7. The Apple CarPlay automatically displays on screen, if not press the home button, press  icon and press the Apple CarPlay icon

Wireless connection

1. Before using Apple CarPlay wirelessly, turn on the Bluetooth and WiFi function on the compatible device
2. Navigate to the Bluetooth settings on your compatible device and select AMUTO53 for pairing
3. A pair message and a pairing request code may appear on your compatible device and head unit. Click allow to accept
4. Apple CarPlay automatically displays on screen, if not press the home button, press  icon and press the Apple CarPlay icon

Wired & Wireless Android Auto™ Operation

NOTE: We recommended that the wired connection method be used for new devices.

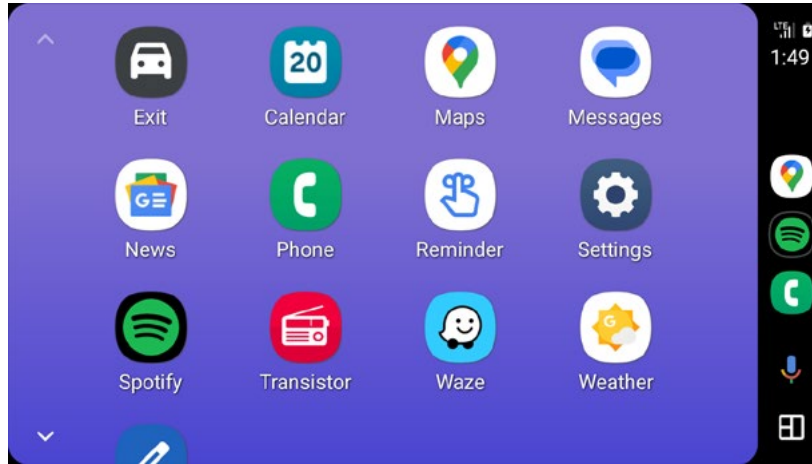

Wired connection

1. Connect an Android Auto™ compatible device to this unit via USB1 (CP/AA/USB Media)
2. Follow on-screen instructions that may appear on your device and head unit
3. Press the Android Auto icon to initiate a connection. The Android Auto home screen appears
4. Once an initial wired connection has been made, connection via the USB connection is no longer required and wireless connection should be automatic.

Wireless connection

1. Before using Android Auto wirelessly, turn on the Bluetooth and WiFi function on the compatible device.
2. Navigate to the Bluetooth settings on your compatible device and select AMUTO53 for pairing
3. A pair message and a pairing request code may appear on your compatible device and head unit. Click allow to accept
4. On first launch, the head unit will ask if you would like to launch Android Auto. Clicking OK will then use Android Auto wirelessly. (This step will only be required on first pairing process)
5. Android Auto automatically displays on screen, if not press the home button, press  icon and press the Android Auto icon
6. Follow on-screen instructions that may appear on your device and head unit

How To Use CarPlay®

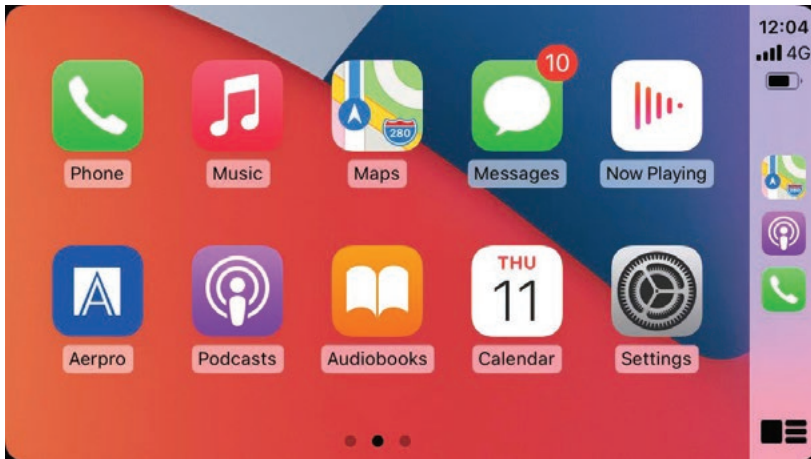

Requirements

- Lightning/Type C Data Cable (For Wired Connections)
- iPhone 5 or later
- iPhone with iOS 7.1 or later
- Data Plan for in app content
- Siri activated

Phone Setup (Before you begin):

1. Apple CarPlay® features may operate differently than on your Apple iPhone®
2. Message and data charges may apply when using Apple CarPlay. Please check with your carrier
3. Apple CarPlay® relies on the performance of your phone. If you experience performance issues:
 - Close all apps and then restart them again
 - Disconnect and then reconnect your phone using the Apple Data cable that was provided with your phone is recommended.
4. When Apple CarPlay® is active, your voice recognition system is disabled and you will be using Siri® to make your requests
5. On your phone, go to **Settings > General > Siri** and ensure Siri is turned ON

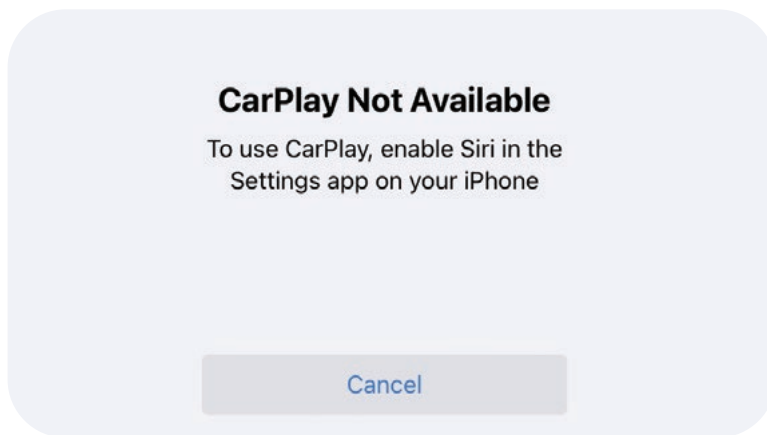

NOTE: For details about Apple CarPlay, refer to the manual supplied with your iPhone, or visit the website of Apple CarPlay.

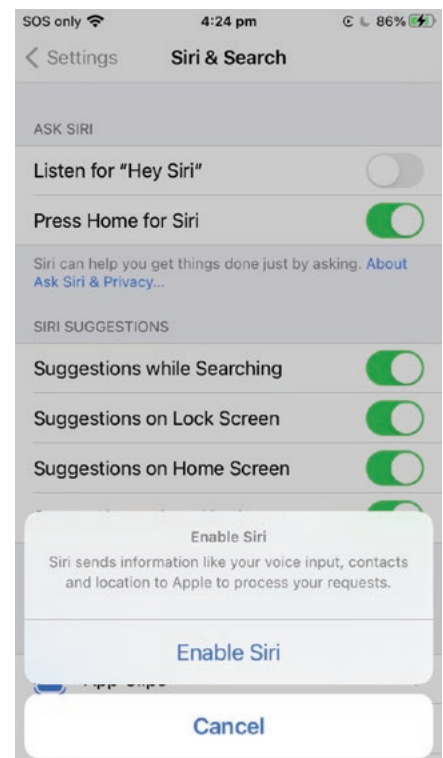

How To Use Android Auto ®

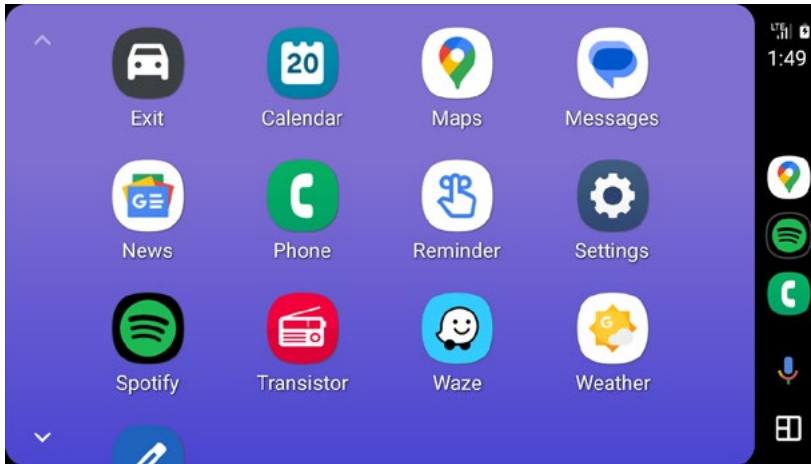

Requirements

- A high-quality USB cable
- Compatible Android® phone with OS Android 8.0 (Wired) 8.0 or higher
- Data Plan for in app content
- Wireless Android Auto requires 5GHz(802.11/ac) WiFi support (refer to **Page 45** of this manual)
- Android Auto App download from the Google Play® store if not on your device
- Android Auto must be available in your country or region

Phone Setup (Before you begin):

1. Android Auto ® features may operate differently than on your Android ® phone.
2. Message and data charges may apply when using Android Auto. Please check with your carrier
3. Android Auto relies on the performance of your phone. If you experience performance issues:
 - Close all apps and then restart them again
 - Disconnect and then reconnect your phone using the USB cable that was provided with your phone is recommended

When Android Auto is active, your in-vehicle voice recognition system is disabled and you will be using Google® voice actions to make your requests

Overview

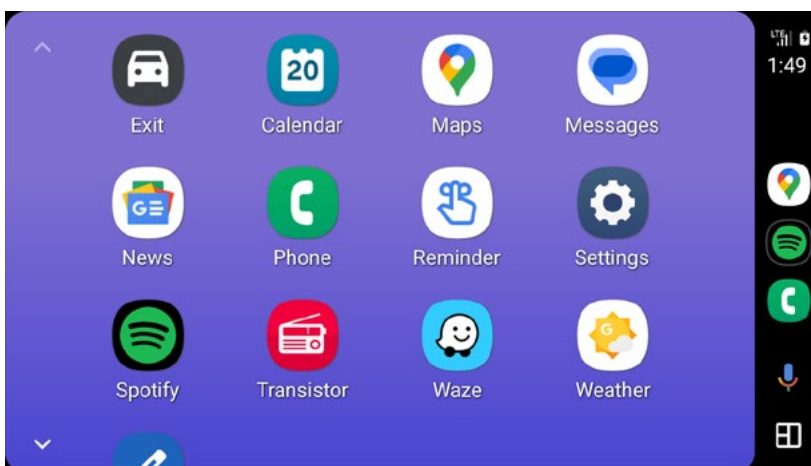

- Android Auto organizes recent actions and information into simple icons on the Android Auto Home screen. Touching an actionable icon will take you to the app.

NOTE: For details about Android Auto, refer to the manual supplied with your Android phone, or visit the website of Android Auto.

Specifications

Display LCD	Size	10.1"
	Resolution	1280*720
Touch Screen	Capacitive	G+G
System Specification	OS System/CPU	Linux 5.10
	RAM / Flash Memory	DDR: 1GB
	CPU	8368-P(Quad cores with A55)
	FLASH	512MB
Power Output	Power Stage Type	Class D
	Maximum Power	4Ch x 50W
	4ohm Max	4Ch x 45W
	4ohm @ 14.4 V, 1 kHz, THD 10%	4Ch x 20W
RCA Preamp Outputs	2-Pair RCA Preamp Output	Yes
	Subwoofer RCA Output	Yes
	Subwoofer Level Control	Yes
	Preamp Voltage	4V
Audio Control	Equaliser Bands	16 Bands
	Loudness	Yes
	Time Alignment	Yes
	Low Pass Filter	Yes
	High Pass Filter	Yes
Media Playback	Audio Formats	MP3, AAC, FLAC
	Video Formats	MP4, Xvid
	4ohm @ 14.4 V, 1 kHz, THD 10%	4Ch x 20W
Device Ports	USB1 Playback formats	CPAA & Media
	USB2 Playback formats	USB Media
	USB Power	5V/1.5A
	USB Max capability	64GB
Aux Inputs / Outputs	Composite Video Output	Yes
	Back-up Camera Input	Yes (Support AHD 720p)
GNSS	GPS Built-in	Yes
	Frequency	1.515G
	Gyro Sensor	Yes
WiFi	WiFi Built-in	Yes (For CP/AA only)
	Frequency	5Ghz

Specifications

Bluetooth	Bluetooth Built-in	Yes (HPF, A2DP, AVRCP)
	ID3 Tag/Information	Yes (Artist, Album, Song)
	HFP Profile	HFP 1.6
	Bluetooth version	V5.0
FM/AM Tuners	AM/FM (Number of Presets)	AM 12 (6X2) / FM 18 (6X3)
	FM Frequency Span (MHz)	87.5-108.0MHz (100KHz Step)
	AM Frequency Span (KHz)	529-1629KHz (9KHz Step)
	RDS	Yes
	FM Antenna Connector Impedance	75ohm
	FM Tuner Connector	Standard DIN
DAB Tuners	DAB Tuner Band	Band III (174-240MHz)
	DAB Tuner Text	Service Label (SL), Dynamic Label (DL), Dynamic Label Plus (DL+)
	DAB Tuner Slideshow	MOT Slideshow
	DAB Tuner Memory + Station list	Yes
	DAB Tuner Phantom Power	12V max 200mA
	DAB Tuner connector	SMB, with cable adaptor to factory harness
Colour Customisation	LED buttons/keys	White
	Selectable Backgrounds	6

FAQ

Google Maps shows a Blue Screen or Location is inaccurate on Apple CarPlay

- With some devices using Google Maps with Apple CarPlay you will have to occasionally open up Google Maps on your phone for location to be accessible on your head unit. This doesn't occur with other mapping applications.

Wireless CarPlay/Android Auto Disconnects under Road Toll Checkpoints

- In some cases your Android Auto or Apple CarPlay may automatically disconnect when going under a road toll checkpoint. However we have made several safeguards to ensure that disconnection is minimised in these scenarios for the Australian market. Regardless your phone should automatically reconnect once you are past the checkpoint

My Mobile phone will not connect to the head unit

- If you are having trouble connecting your phone to the head unit, try restarting your phone and try again.
- It is also recommended to do a factory reset on the head unit as this will solve most of the connection issues between your phone and your head unit.
- If you are having issues with connecting Android Auto or Apple CarPlay over a USB connection, try using another high quality/shorter length cable. Using low quality cables and longer lengths may cause issues such as drop outs and or connection issues.
- Make sure your phone is up to date with the latest software updates.

Do I have to connect the GPS module for Android Auto/Apple CarPlay to work?

- It is highly recommended to connect the GPS retention harness to the head unit and place it where it has a clear line of sight to the sky as it will assist the GPS tracking for maps when using Android Auto or Apple CarPlay.
- If you do not use the GPS module then the GPS tracking will rely purely on your phone's tracking performance which may be spotty depending on the location of the phone in the vehicle.

Issue with microphone on hands-free calls

- Try increase or decreasing the gain in the settings menu.
- Ensure that the microphone plug is connected to AV Harness Microphone Input.
- Make sure that your vehicles factory microphone is connected and working correctly.

FAQ

No sound from Factory speakers/Amplifier

- Ensure that there are no other connectors besides the 59 pin plug, connected to the back of the climate control system. If the brown and green connectors on the back of the climate control system may cause audio issues.
- Check to make sure that MOST adaptor is connected to the factory plug.
- Check that the white male RCA plug labelled (Stereo) is inserted into the back of the head unit next to the blue 360 camera connector.

360 Camera not working

- Please refer to the installer notes or the installers manual for instructions explaining what type of 360 camera is required for your vehicle.

No 360 Camera Plug? I have a Reverse Camera vehicle only?

- Your factory reverse camera is required to be upgraded using the supplied AHD 720p reverse camera.
- Please refer to the install manual for more information on wiring and information.
- This kit has not been configured to retain the original reverse camera as it is low resolution.
- Upgrading the camera is necessary to retain the reverse camera function.

Can I view my 360 Camera while Driving?

- You can only view the 360 camera system based on what's applicable from the vehicles manual.
- However you can view the second camera anytime from the second page of the main menu as long the second camera is correctly wired and can either be powered the 'F. Camera 12v Out' or separately powered.

Are the Rear Entertainment Screens unusable

- Although the rear entertainment systems are no longer communicating to the headunit, they can still be used independently.
- You can still use the HDMI or AV input under the rear climate to play content on the rear screens. These can include DVD players or phone mirroring dongles as long as it can display at a resolution of 576p, 480p or VGA as detailed in the vehicles manual.

FAQ

Microphone Not Working

- Please double check you have the microphone connector inserted correctly as per the install manual and wiring guide.
- Double check the Wires & Pins are correctly inserted on the main 59 pin harness.

Microphone Quality Issues

- It is completely normal for feedback to be heard for the first minute of a call. This will stabilise and quality will be clear.
- The audio is a lot clearer on the drivers side than the passengers side, so ensure testing is done while sitting in the driver's seat.

Network Instability while using the Wireless Charging Pocket & Android Auto/Apple CarPlay

- If you are using the factory wireless charging pocket from your vehicle, then you may experience intermittent interruptions with Mobile Data & Wireless Android Auto/Apple CarPlay. This may be due to the interference from the wireless charger itself (even when turned off) & due to the physical location of the pocket.
- If you experience these issues you may have to place your phone in a different location with less physical interference such as your cup holders or a phone mount.

FAQ

My Android phone will not connect wirelessly to the head unit

Your mobile phone must be a compatible Android phone with an active data plan, 5 GHz WiFi support (802.11/ac), and the latest version of the Android Auto app.

Compatible Android phones include:

- Any phone with Android 11.0 or above
- A Google or Samsung phone with Android 10.0 or above
- A Samsung Galaxy S8, Galaxy S8+, or Note 8, with Android 9.0 or above

If your phone does not meet the compatible Android phone list but has 5 Ghz WiFi support, you can follow these steps.

(NOTE: We cannot guarantee this will provide a reliable Wireless Android Auto experience and is used as a work around for older phones)

1. Go to the settings of the Android Auto app
2. Scroll down to the bottom where it states version number
3. Tap this several times until a pop up message appears asking to enable Developer options. Accept this message
4. Tap on the 3 dots in the top right corner and choose Developer Settings
5. Scroll down until you can find 'Add wireless projection to settings' and enable this. (Make sure that it is also ticked in the settings of Android Auto under 'Wireless projection' section)
6. Try the connection process again

If you are still having issues connecting your Android phone wirelessly to the head unit, try the steps below.

1. Navigate to your Android Settings
2. Scroll and tap on the 'Apps' Settings
3. Tap on 'Android Auto'
4. Scroll to 'Storage' & tap on it
5. Clear Cache first on the right side
6. Then 'Clear Data'
7. Press 'Delete' on the pop-up message
8. Turn off WiFi
9. Navigate to your Bluetooth Settings
10. Tap the Cog on the previously paired Aerpro head units Bluetooth. If you have not previously paired with the head unit, you can skip to re-pairing your phone with the Aerpro head unit.
11. Tap Unpair.
12. Now you can begin pairing with your Aerpro Head unit and follow the steps from the pairing procedure in the manual.

If you are still having issues, try restarting your phone and going through this process again.

Technical assistance

If you need assistance setting up or using your Aerpro product now or in the future, call Aerpro Support. Australia

TEL: 03 – 8587 8898

FAX: 03 – 8587 8866 Mon-Fri 9am – 5pm AEST or EMAIL: service@tdj.com.au

If you would like to download a digital copy of this manual, or other Aerpro manuals/software, please visit the Aerpro.com website and search for the product model number for more information, accessories and products.

This manual is considered correct at time of printing but is subject to change. For latest manuals and updates refer to the website.

Copyright © 2024 by TDJ Australia

All rights reserved. No part of this publication may be reproduced, distributed, or transmitted in any form or by any means, including photocopying, recording, copying or other electronic or mechanical methods, without the prior written permission of the author.

AERPRO.COM



Scan here for more information on vehicle retention and integration.



Apple CarPlay is a trademark of Apple Inc. Use of the Apple CarPlay logo means that a vehicle user interface meets Apple performance standards. Apple is not responsible for the operation of this vehicle or its compliance with safety and regulatory standards. Please note that the use of this product with iPhone, iPod, or iPad may affect wireless performance. Apple CarPlay requires a compatible device, mobile data, network reception & GPS signal. Mobile usage at user's cost. Please visit apple.com/au/ios/carplay/ for device compatibility.

Apple, iPhone, iPod, iPad and Siri are trademarks of Apple Inc., registered in the U.S. and other countries. Apple CarPlay is a trademark of Apple Inc.

Android, Android Auto, Google Assistant, and Google are trademarks of Google Inc.

Availability of Android Auto may vary depending upon your country and phone model. To wirelessly use Android Auto on your car display, you need a compatible Android smartphone with an active data plan. You can check which smartphones are compatible android.com/auto.

While this product is compatible for use with Bluetooth, it is not made or endorsed by Bluetooth SIG inc.

DAB+ and all related marks and logos are trademarks of WorldDAB. All rights reserved.

Other trademarks and trade names are those of their respective owners.

Some vehicle features may not be retained, or may function differently. For more information visit aerpro.com. iPhones, Android smartphones or any other accessories shown or listed are not supplied and must be purchased separately.

Design and specifications are subject to change without notice.

25-09-2024
v1.1 Firmware