

## APBT225 Bluetooth Car FM Transmitter User Manual

Thank you for purchasing our Bluetooth car charger with FM transmitter. This manual is written to help you to learn how to use the product. Please read the manual carefully before use.

### I. Product Profile

This product is an FM transmitter that will allow you to play your music and receive hands-free phone calls through your car stereo. It can fast charge smartphones and play files such as WMA, WAV, MP3, APE and FLAC via either Bluetooth, or micro SD.

### II. Product appearance

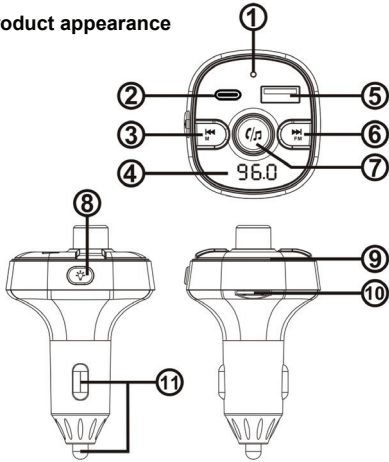

1. Microphone
2. USB1 PD 36W fast charging port
3. Short press for previous track. Long press to enter mode switch (BT/Micro SD)
4. LED display

### 5. Redialing a call

When the bluetooth hands-free is idle at start-up, double pressing the  button will redial the last phone number.

### 6. Play music stored in your phone.

This product supports A2DP function, and can play music stored on your mobile phone. The music is transmitted to the car audio system through Bluetooth.

### 7. Mobile music / SD(TF)

Long press the  button to switch the mode:

BT --- SD (TF).

After connecting the bluetooth, select the song to play or insert the Micro SD card to automatically read and play the music.

### 8. Siri / voice assistant function

Once paired via bluetooth, to use the Siri/Voice Assistant, press and hold the  button for

3 seconds to activate. (Supported mobile phone brands are: iPhone, Samsung, and Android system mobile phones). Note: Some phones do not support this feature.

9. Colour changing light. Short press the  button to change the RGB light to cyan, blue, purple, red, orange, green, shut-off. Long press for pulse cycle mode.

5. USB2 QC3.0 fast charging port
6. Short press for next track. Long press to enter FM mode
7. Multi-functional key for play/pause/answer/reject/redial/V+/V-., Long press to activate the Siri/Google voice assistant
8. Rainbow LED button, Short press to switch the color/long press to enter auto color change mode
9. LED colour bezel
10. Micro SD card slot
11. 12/24V socket

### III. Features

1. Suitable for all types of vehicles.
2. LED display.
3. Supports QC3.0 charging output
4. Supports iPhone and iPad charging
5. Supports stereo FM transmission technology
6. Supports Micro SD card for playing music (Max 64GB)
7. Supports WMA, MP3, WAV, APE & FLAC music formats
8. Automatic power off memory function
9. Supports Bluetooth A2DP, AVRCP, HFP, HSP
10. Bluetooth V5.3
11. Bluetooth hands-free calling
12. Supports Bluetooth stereo music DSP technology
13. Battery voltage detection

### IV. Operation Instructions

1. Plug the product into the vehicle cigarette lighter socket and it will be automatically powered with the LED flashing and displaying HI→Battery Voltage→BT→FM frequency

2. Turn on your car FM radio, and adjust the frequency of APBT225 to match your vehicles radio. Choose a frequency that is not being used.

3. Adjust FM frequency  
Long press  to enter state.

Rotate the  button left and right to adjust the transmission frequency from 87.5 ~ 108MHZ. 3 seconds without operation will exit the FM state.

### VI. Tech specification

Rated working voltage	12V~24V
Limit working voltage	10-26V
PD / USB output	36W / 18W
Working temperature	0-50 °C
<b>Music format</b>	MP3/WMA/WAV/APE/FLAC
SNR	>60dB
Battery voltage display accuracy	±0.5V
USB 1 output	PD 36W
USB 2 output	QC3.0 (5V-12V)
Frequency response	20Hz-15Khz
Left and Right Channel	>60dB
bluetooth version	Version 5.3
bluetooth sound processing	DSP and A2DP
FM Transmission distance	10M
Effective distance of bluetooth microphone	0.5-2 M
FM frequency	87.5-108MHz
Transmit FM mode	Stereo digital PLL lock frequency

### VII. Notice

1. Do not turn the radio volume too high (usually 18 or below) to avoid the increase of the echo.
2. Although the transmission power of this product is relatively strong, better to skip the Frequency with strong signal in the local area to get a better sound quality.
3. Do not use the product in extremely high or low temperatures and in dusty, humid environments.
4. Avoid dropping the product to prevent damage to the surface or the body.
5. Do not disassemble the unit. If you have any questions, please contact your dealer.
6. Changes in product performance and functionality due to continuous improvement are subject to change without notice.

### 4. Bluetooth Pairing

When connecting the APBT225 with a mobile phone for the first time, it may need a pin code to finish the connection, for more details, please refer to the relevant manual.

5. Please open Bluetooth on your mobile phone and search for the device "APBT225" from phone menu list.
6. Select the device "APBT225"
7. Once the device has successfully connected exit your Bluetooth settings on your phone.

### V. Matching connection for additional devices

At boot time, the bluetooth car hands free will only automatically start connecting to the matching device that was connected last time.



Note: Some phones can be automatically connected when the bluetooth car is powered off after a power-free call. Some phones may need to grant permission for each connection. You can set it to "Automatically connect" For more information, please refer to the phone's user manual.

1. Use bluetooth hands-free calling  
(When your bluetooth hands free is idle or playing music)

### 2. Dial number

In the connected state, the phone number is directly dialed out by the mobile phone, and the sound is automatically sent through the cars audio speakers.

### 3. Answering the phone

In the connected state, to answer an incoming call, press  to answer. Press  again to hang up.

### 4. Rejecting a call

Long press  to reject incoming call.

### VIII. Technical Assistance

If you need assistance setting up or using your Aerpro product now or in the future, call Aerpro Support. Australia. Mon-Fri 9am – 5pm AEST  
TEL: 03 – 8587 8898  
FAX: 03 – 8587 8866



Please retain this user guide for future reference. If you would like to download a digital copy of this manual, or other Aerpro manuals/software, please visit the Aerpro.com website and search for information on your model.