

CAVW01

INFODAPTER INSTRUCTION MANUAL *for select Volkswagen vehicles*

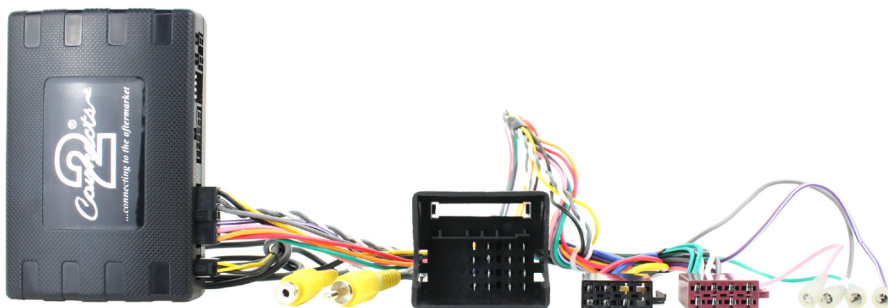

Vehicle Application

Volkswagen EOS 2009 - 2016
Volkswagen Golf 2008 - 2013
Volkswagen Multivan 2010 - 2015
Volkswagen Passat* 2010 - 2015
Volkswagen Polo 2009 - 2014
Volkswagen Scirocco 2011 - 2015
Volkswagen Sharan 2010 - 2015
Volkswagen Tiguan 2011 - 2015
Volkswagen Touran 2010 - 2015

Only for Models with White MFD

*Compatible with Fender OEM Amplified System

Designed and
Engineered
in the UK. 

ABOUT

The Infodapter for VW vehicles allows vehicle information such as climate control, parking sensors and heated seats to be displayed on any aftermarket head unit with rear camera input. The Infodapter also allows the use of the steering wheel controls with almost every steering wheel control compatible head unit on the market.

DIP SWITCH SETTINGS

See Fig 1.

Up = Off, Down = On

1: On = Pioneer head units. Off = All other head units

2: Setting for reverse camera. On = PAL, Off = NTSC. The default setting is Off (NTSC).

3: Resets the display settings back to default. If the display settings have been manipulated in a way that it is no longer possible to make adjustments, change the DIP switch #3 from Off to On and back. This will reset the screen settings to the factory defaults. During this procedure the screen background will change to red. While the background is red, no settings can be made.

4: Not applicable

INTERFACE CONNECTIONS

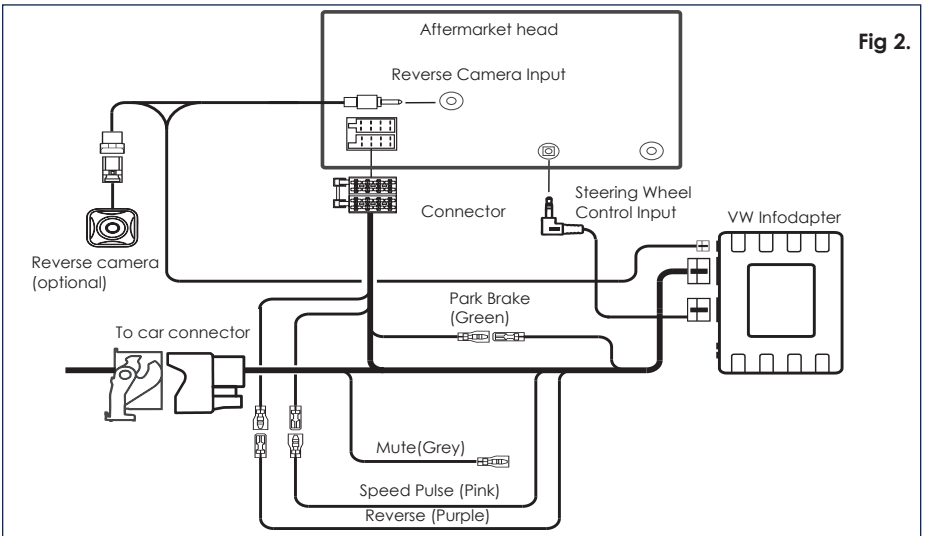
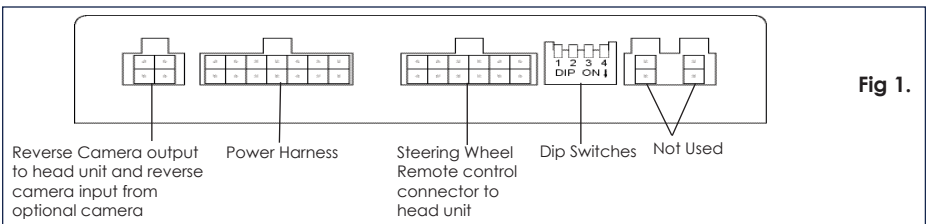

STEERING WHEEL CONTROLS

À Speech Button

B/C Track Up/Down

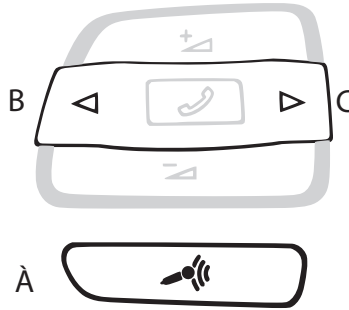
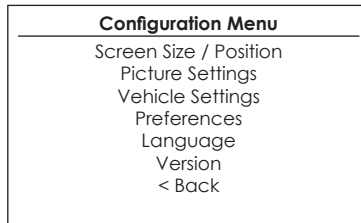

Fig 3.

CONFIGURATION MENU

To access the menu, **push and hold the speech button** for 2 seconds (Fig. 3). This will enable the configuration menu. To navigate through the menu options use the **Track Up/Track Down buttons**. To select a menu option, push the **speech button once**.



- **Screen Size/Position**
Make sure all 4 corner markers are touching the corners of the aftermarket head unit display.

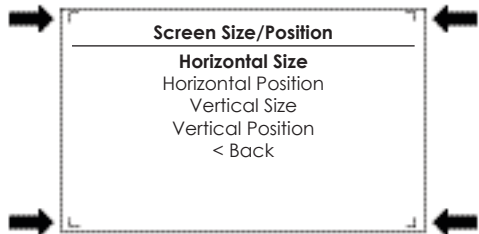

- **Picture Settings**
Adjust brightness, contrast, and colour saturation.

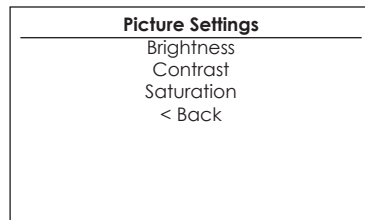

CONFIGURATION MENU

- **Vehicle Settings**

- Driver Position - Select Left or Right depending upon vehicle configuration.

- **Amplifier Settings**

- Amplifier Settings* - This setting can be used to adjust the gain of the aftermarket head unit, to match the the OEM amplifier volume. (*Note this option is only available when an OEM amplifier is detected in the vehicle)

- **Preferences**

Park Assist Version - Select according to the colour configuration of the park assist fitted to the vehicle.

Camera Connected - Select Yes if an optional camera is connected.

Reverse Priority* - Select which image (Camera or Park Assist) will be shown by default when reversing. The driver can select the desired image by pushing the Speech button (Fig.3) while reversing. (*Note this option is only available when Camera Connected is set to Yes)

Park Brake Source - Set to one of the following:
Brake - Park brake output active when park brake is on.
Speed - Park brake output active when speed is less than 3KMH
Always On - Park brake output always active.

Restore factory settings - Reverts all Infodapter settings to factory defaults. (This does not restore vehicle settings)

Vehicle Settings	
Driver Position	Left
Amplifier Settings	
<Back	

Amplifier Settings	
Volume	2
Balance	0
Fader	0
Bass	0
Mid	0
Treble	0
On Delay	0
< Back	

Preferences	
Park Assist Version	0
Camera Connected	Yes
Reverse Priority	Park Assist
Park Brake Source	Always On
Restore factory settings	
< Back	

If you need assistance setting up or using your Aerpro product now or in the future, call Aerpro Support Australia
TEL: 03 – 8587 8898 FAX: 03 – 8587 8866 Mon-Fri 9am – 5pm AEST. If you would like to download a digital copy of this manual, or other Aerpro manuals/software, please visit the <http://aerpro.com> website.

Legal Information

Please consult the relevant road traffic laws governing the country in which this product is being operated. No liability is accepted for material damage, loss or personal injury, directly or indirectly, from installation and operation of this product. This product should only be operated when safe to do so.