

Clarion®

FX450

DISPLAY AUDIO Bluetooth®
Apple CarPlay Android Auto™



CONTENTS

1. FEATURES	3
2. PRECAUTIONS	3
3. CAUTIONS ON HANDLING	3
4. ENVIRONMENTAL INFORMATION	3
5. BASIC OPERATIONS	4
5.1 Overview of the unit.....	4
5.2 Initial Settings.....	4
5.3 Power Off Clock.....	4
6. LISTENING TO THE RADIO	5
7. USB PLAYBACK	6
8. BLUETOOTH PHONE	7
8.1 Pairing the Bluetooth device	7
8.2 Receiving a Call	7
8.3 Call Waiting	7
8.4 Phonebook	7
8.5 Call Records	8
8.6 Voice Assistant	8
8.7 Bluetooth Setting Menu	8
9. BLUETOOTH AUDIO	9
10. SMARTPHONE CONNECTIVITY	10
10.1 About Apple CarPlay.....	10
10.2 About Android Auto.....	11
11. SETUP MENU	12
11.1 System Settings.....	12
11.2 Parking Camera.....	14
11.3 Phone Devices.....	14
11.4 Bluetooth Settings.....	14
11.5 Software Information.....	14
12. 24Bit DSP AUDIO	15
13. TROUBLESHOOTING	16
14. INSTALLATION AND CONNECTION WIRE	17
14.1 Before Starting.....	17
14.2 General Cautions.....	17
14.3 Installing the Unit.....	17
14.4 Trim Ring Installing.....	17
14.5 Wiring and Connections.....	18
15. SPECIFICATIONS	19

1. FEATURES

- AM/FM Radio
- Rear USB
- Built-In Bluetooth®
- Rear AV-IN
- Reverse Camera In
- Dash CAM Ready
- DSP Audio Processor
- USB Charge 1A
- 50Wx4 Built-In Amplifier
- Apple Carplay
- Android Auto



2. PRECAUTIONS

▲ WARNING

For your safety, the driver should not operate the controls while driving. Also, while driving, keep the volume to a level at which external sounds can be heard.

1. This unit has precision parts inside. Even in the event that trouble arises, never open the case, disassemble the unit, or lubricate the parts.

FCC STATEMENT

1. This device complies with Part 15 of the FCC Rules. Operation is subject to the following two conditions:
 - (1) This device may not cause harmful interference, and
 - (2) This device must accept any interference received, including interference that may cause undesired operation.
2. any Changes or modifications not expressly approved by the party responsible for compliance could void the user's authority to operate the equipment.

NOTE:

This equipment has been tested and found to comply with the limits for a Class B digital device, pursuant to Part 15 of the FCC Rules. These limits are designed to provide reasonable protection against harmful interference in a residential installation. This equipment generates uses and can radiate radio frequency energy and, if not installed and used in accordance with the instructions, may cause harmful interference to radio communications. However, there is no guarantee that interference will not occur in a particular installation. If this equipment does cause harmful interference to radio or television reception, which can be determined by turning the equipment off and on, the user is encouraged to try to correct the interference by one or more of the following measures:

- Reorient or relocate the receiving antenna.
- Increase the separation between the equipment and receiver.
- Connect the equipment into an outlet on a circuit different from that to which the receiver is connected.
- Consult the dealer or an experienced radio / TV technician for help.

IC warning
- English:
This device contains licence-exempt transmitter(s)/ receiver(s) that comply with Innovation, Science and Economic Development Canada's licence-exempt RSS(s). Operation is subject to the following two conditions:
(1) This device may not cause interference; and
(2) This device must accept any interference, including interference that may cause undesired operation of the device.

FCC/ IC Radiation Exposure Statement
This equipment complies with FCC and IC radiation exposure limits set forth for an uncontrolled environment. This equipment should be installed and operated with minimum distance 20cm between the radiator&your body.

- French:
Cet appareil contient des émetteurs/récepteurs exemptés de licence conformes aux RSS(RSS) d'Innovation, Sciences et Développement économique Canada. L'exploitation est autorisée aux deux conditions suivantes :
(1) l'appareil ne doit pas produire de brouillage, et
(2) l'utilisateur de l'appareil doit accepter tout brouillage radio électrique subi, même si le brouillage est susceptible d'en compromettre le fonctionnement."

FCC/ IC Déclaration d'exposition aux rayonnements
Cet appareil est conforme à FCC et IC l'exposition aux rayonnements limites fixées pour un environnement non contrôlé. Cet appareil doit être installé et utilisé avec une distance minimale de 20 cm entre le radiateur et votre corps. Cet transmetteur ne doit pas être co-situé ou opérant en liaison avec toute autre antenne ou transmetteur.

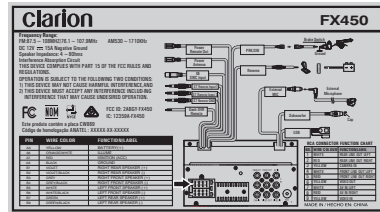

3. CAUTIONS ON HANDLING

- Protect from high temperature. Expose to direct sunlight for an extended period of time can produce very high temperature in your vehicle. Cool down the interior before starting the playback.

4. ENVIRONMENTAL INFORMATION

- This product contains metallic and plastic recyclable materials that could be reused.

5. BASIC OPERATIONS

◆ Overview Of The Unit

• Functions of the Buttons on the Head Unit



[MUTE/POWER]

- Press and hold to turns the power off. When the power off, turns the power on.
- Press to mute the audio output, press it again to unmute the audio output.

[+/-]

Press to increase/decrease the volume.

[HOME/VOICE]

- Press to displays the HOME screen
- Press and hold to displays the voice recognition screen

[DISP]

- Turns the screen off disabling it without interrupting the current playback.
- Press & hold to turn off the displays.

• Home Screen Descriptions

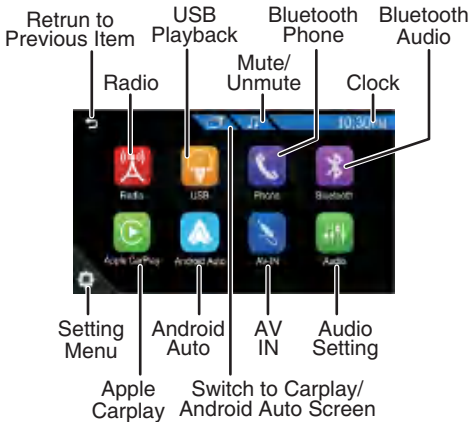

◆ Initial Settings

NOTE
Perform this setup when you use this unit first time.

To select the suitable Language/Country Area list of areas, and turn on or off the Demo function, tap **Finish** to confirm.

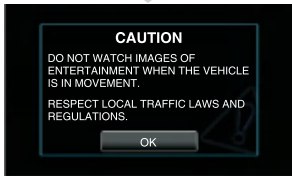
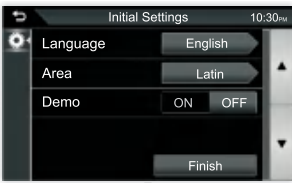

The warning is only for 6 seconds

◆ Power Off Clock

- Press and hold **POWER** on front panel to power off the unit, the display screen will display the clock.

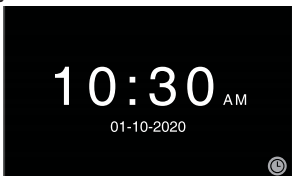

- Tap **CLOCK** to switch the Clock display mode



- Press **POWER** on front panel again to return the previous playback mode.

NOTE
Tap **Settings** access system settings menu to Enable/Disable the **[Power Off Clock]**.

6. LISTENING TO THE RADIO

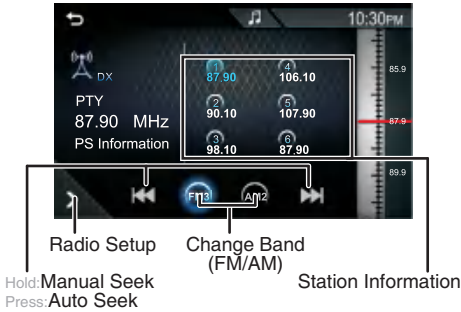

◆ Radio Setup

Tap on button to access the Radio Setup Menu.

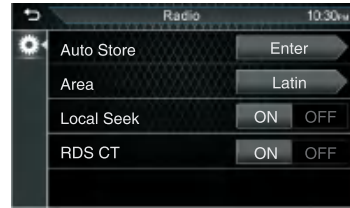

◆ Selecting The Radio Band

Tap on / buttons to select one radio band among FM/AM.

◆ Auto Seek

Tap on [/] buttons to automatically search for the next radio station.

◆ Manual Seek

Tap and hold [/] buttons to Manual search for the next radio station.

◆ Presets

Tap and hold to select the preset position to save the current frequency.

◆ Recalling a Preset Station

A total of 6 preset positions exists to store individual radio stations in memory.

Tap on to select the desired preset station.

● Auto Store

Automatically searches and stores the 6 stations with the strongest signals for the selected band.

● Area

This option allows you to select the difference radio tuner frequency spacing.

BRAZIL (South America)

USA (United States of America)

LATIN (Latin America)

EUROPE (Western Europe)

ASIA (Asia Pacific)

AUSTRALIA (Australia)

● Local Seek

Tunes in only to the stations with sufficient signal strength.
“ON”, “OFF” (Default)

● RDS CT

This option turn on will automatic synchronise the clock & date from the radio broadcast if available.

7. USB PLAYBACK

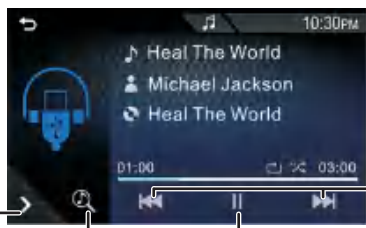

Music Function Setup Media Content List Play/Pause Track Up /Down

◆ Play / Pause

Tap on [▶/||] to Play/Pause audio playback.

◆ Selecting a Track

Tap on [◀◀ / ▶▶] to move to the beginning of the previous/next track. Tap and hold to Fast forward/backward.

◆ Music Function Setup

Tap on [▶] to access the USB settings Menu.

• Repeat

☑ All:Repeats all files

☑ One:Repeats current file

☑ Folder:Repeat all files in current folder

• Random

☒ On:Random plays all files

☒ Off:Normal playback

◆ Media Content List

1. Tap on [🔍] to display the Playback List.
2. Select whether you search by audio files 🎵 / video files [▶].



3. Tap [▲] / [▼] to move to the hierarchy.
4. Touch the desired folder. When you tap a folder its contents are displayed.
5. Tap desired item from the content list, the playback starts.

NOTE: Tap [↑] to return the top menu.

◆ Video Playback

⚠ WARNING

- Risk of road accidents! Never watch video or TV while you drive.
- Park your car in a safe place and pull up the parking brake to watch or operate the device.

1. Tap on [🔍] to display the Playback List.
2. Tap on [▶], and then tap desired item from the content list.

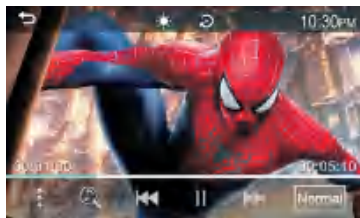

- ☀:Adjust image quality in video screen
- ⌛:Reset to the factory settings
- ⋮:Access into Media Setup mode
- 🔍:Searches file
- ◀◀/▶▶:Searches the previous/next content. Tap and hold to fast forward or fast backward
- ▶/||:Play/Pause
- **NORMAL 4:3 / 16:9** : Select a screen mode

8. BLUETOOTH PHONE

◆ Pairing the Bluetooth device

You can use your Bluetooth smartphone when paired to this unit.

1. Turn on the Bluetooth function on your Phone.
2. Search the unit (**Clarion**) from your phone. If a PIN code is required, Enter the PIN code (**0000**).
3. If the pairing is successful, iPhone X-123... appears when the Bluetooth phone is connected.

◆ Making a Call

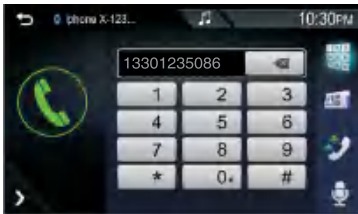

1. Enter a phone number with number keys.

2. Tap to make a call.

- : To delete the last entry
- : Dial Keypad
- : Phonebook (if you are linking your phone for the first time, the radio will be download the phone book.)
- : Call records
- : Voice Recognition
- : Device List

◆ Receiving a Call

Touch to answer a phone call or

to reject an incoming call.

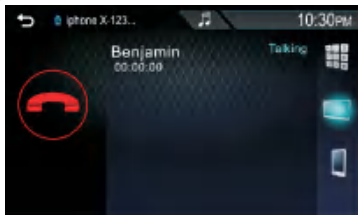

- : Entering a phone number
- : Tap to switches the speaking voice output between smartphone & speaker

◆ Call Waiting

1. When you receive a call while talking on another call, you can answer the newly received call by taping . The current call is on hold.

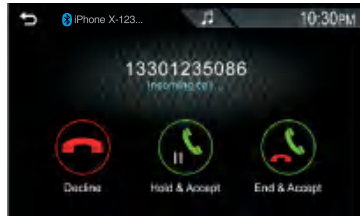

2. Each time you tap , the caller will change.

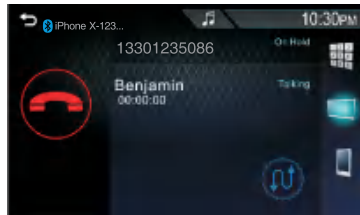

3. When you tap , the current call will end and switch to the call in hold.

◆ Phonebook

- Tap will start downloading the Phonebook.

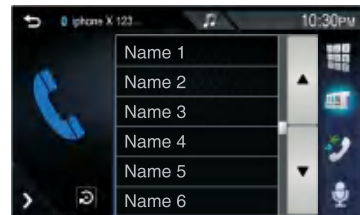





- Select the person you want to call from the list.
- Select the phone number from the list.

8. BLUETOOTH PHONE

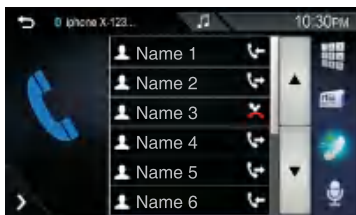
◆ Call Records

- Tap  to select the phone number from the Call records list.



-  Received Calls
-  Outgoing calls
-  Missed call

◆ Voice Assistant

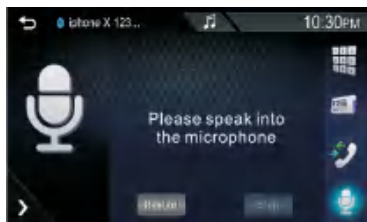

- Tap  to access the voice recognition function of the phone connected to this Car AV System.



NOTE:

- This function must be operated in a state before connection Bluetooth.
- You can use voice recognition function by press and hold  VOICE on the front panel.
- The Voice function is dependent on mobile phones, some Android phone don't have this function.

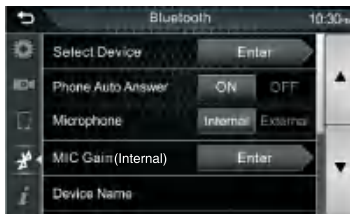

◆ Bluetooth Setting Menu

1. Tap  to access system settings menu.
2. Tap  to display the Bluetooth settings mode, and tap on a setting repeatedly to change setting.



• Select Device

Tap the Device name you want to connect.

-  :To connect the device
-  :To disconnect the device
-  :To delete the registered Bluetooth device

• Mic Gain

If the microphone volume is too low or the volume is not ideal enough for listening from a long distance. You can use this function to adjust the sensitivity of the microphone.



9. BLUETOOTH AUDIO

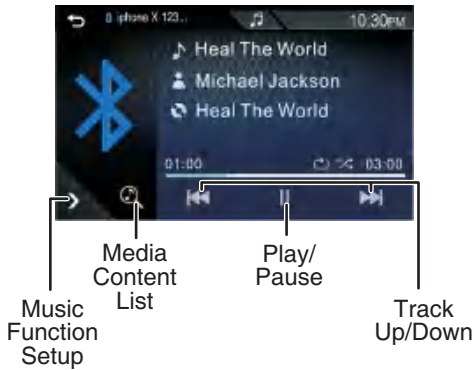

◆ Play / Pause

Tap on [▶ / ||] to Play / Pause audio playback.

◆ Selecting a Track

Tap on [◀◀ / ▶▶] to move to the beginning of the previous/next track. Tap and hold to Fast forward/backward.

◆ Music Function Setup

Tap on [▶] to access the Music playback Function Setup Menu.

• Repeat

↻ All:Repeats all files

↻ One:Repeats current file

↻ Folder:Repeat all files in current folder

• Random

⌘ On:Random plays all files

All ⌘ Off:Normal playback

◆ Media Content List

1. Tap on 🔍 to display the Playback List.
2. Select whether you search by audio files 🎵 .



3. Tap ▲ / ▼ to move to the upper hierarchy.
4. Touch the desired folder. When you tap a folder its contents are displayed.
5. Tap desired item from the content list, the playback starts.

NOTE

Tap [⬆] to return the top menu.

10. SMARTPHONE CONNECTIVITY

About Apple CarPlay

CarPlay is a smarter, safer way to use your iPhone in the car. CarPlay takes the things you want to do with iPhone while driving and displays them on the screen of the product. You can get directions, make calls, send and receive messages, and listen to the the music from iPhone while driving. You can also use Siri voice control to make it easier to operate iPhone.

NOTE:

Some features, applications, and services are not available in all areas. For details, visit <http://www.apple.com/ios/carplay/>

◆ Connect an iPhone

Connect an device via USB terminal.



NOTE:

- It is recommended to use only original cables.
- If iPhone CarPlay connection to the Car AV System is not successful, please unplug and insert USB cable and try again.
- When iPhone compatible with CarPlay is connected to the USB terminal, the Bluetooth smartphone currently connected is disconnected.

◆ CarPlay Sidebar

Under Setup Menu, tap get into the Phone Devices to select the position of the control bar (Left or Right) shown on the touch panel.



NOTE

Please unplug the USB cable after you change the CarPlay Sidebar option.

Operation of Apple CarPlay

◆ Operation button on CarPlay



Switch forward and backward between Apple CarPlay and Playback mode

◆ Operation button on CarPlay Home



Exits the CarPlay screen and displays the HOME screen
 Hold: To activates Siri
 Press: Display the home screen of CarPlay

10. SMARTPHONE CONNECTIVITY

About Android Auto

Android Auto enables you to use functions of your Android device convenient for driving. You can easily access route guidance, make calls, listen to music, and access convenient functions on the Android device while driving.

For details about Android Auto, visit the below address:

<https://www.android.com/auto>
<https://support.google.com/androidauto>.

NOTE:

- *Compatible Android devices You can use Android Auto with Android devices of Android version 5.0 (Lollipop) or later.*
- *Android Auto may not be available on all devices and is not available in all countries or regions.*

◆ Connect Android phone

Connect an device via USB terminal.



NOTE:

- *It is recommended to use only original cables.*
- *If Android Auto connection to the Car AV System is not successful, please unplug and insert USB cable and try again.*

◆ Initial setup Android Auto

When you use Android Auto first time, you must engage parking brake and follow the instructions to do on your phone.

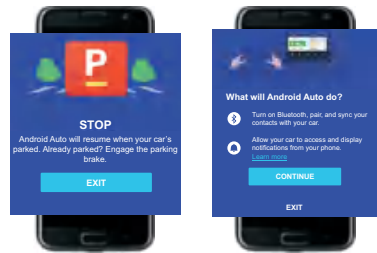
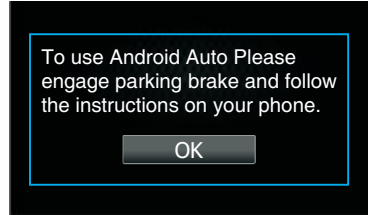

Operation of Android Auto

◆ Operation button of Android Auto

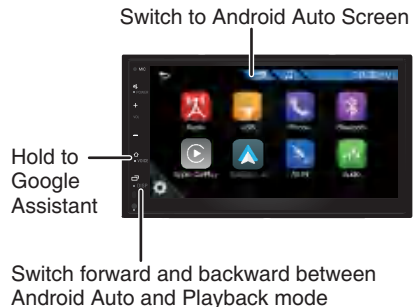



11. SETUP MENU

Tap  access into Setup Menu to select the item to be adjusted.

System Settings

Tap  access into System Menu to set the below items:

◆ Time/Date

Tap   to set the Time/Date.

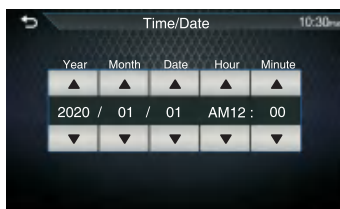

◆ Clock Mode

Tap to adjust the clock.



◆ Dimmer

Tap into the Dimmer mode, can set the demonstration:

Time Mode: Adjust the dimmer according to the time mode

Auto(Default): To dimmer the display automatically when you turn lights on.

Day: adjust brightness for bright ambient light

Night: Adjust the brightness for the dark surrounding light. Tap  Low  to set the Night level: Low/Mid/High. The default level is Low.

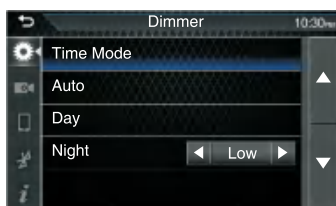

◆ Wallpaper

Tap into the Wallpaper mode, can set the background image.

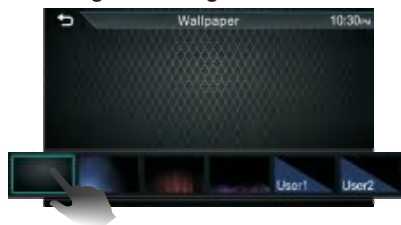

- To selecting the image set to background. The default is First Image.

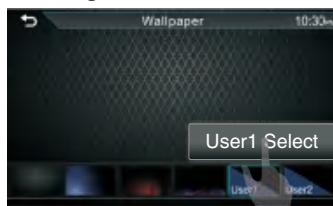

User Wallpaper

You can set the background image from stored in USB device on yourself. Before operating this procedure, it is necessary to connect the device which has the image to load.

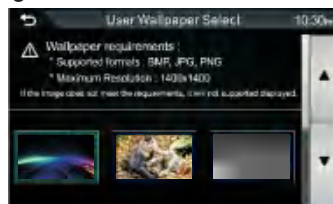

- Tap   select the image to load.



- Tap   to select the image from Stored in USB device.



- Tap  to confirm the selection.

11. SETUP MENU

◆ Beep Tone

Tap to activate the keyboard sound.

◆ Steering Remote Controller



You can set the desired function in the Steering Remote Controller.

- Select the function you want the Steering Remote to learn



- Press and hold the same function button on the Steering Wheel Remote until "SUCCESS" is displayed.



- Tap  to reset all SWC learning records, and tap  cancel or stop the current button learning

NOTE:

SWC must be connected to use this function.

◆ Language

Tap to select the Language.

◆ Demo

Turn On or Off the demonstration mode. The default is Off.

◆ Power Off Clock

Tap to Enable or Disable the power off clock mode.

◆ AV Setup

Tap into the Rear AV-IN mode sets the [AV-IN] / [DTV] / [DVR] mode, then activate the selection function.

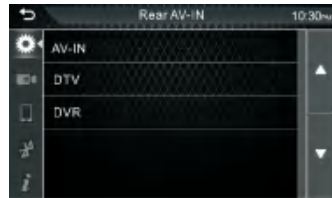

◆ Default Volume

This function allow to change the Default Volume Level.

The default volume level is 15.





NOTE:

- The volume is over than the default level 15, When turn ACC /Power Off and Restart, the volume will be default level 15.
- The volume is less than the default level 15, When turn ACC/ Power Off and Restart, the volume will be keep the current level.

11. SETUP MENU

Parking Camera

- GO to Setup menu for find the 
- Tap  access into Camera menu to adjust the Parking Guide Adjust.

◆ Camera

Tap into the Camera IN mode selects [Rear Camera] / [DVR] mode, then activate the selection function.

◆ Parking Guidelines

You can display parking guidelines to enable easier parking when you shift the gear to the reverse (R) position. The default is "ON".

◆ Guidelines Setup

If you select [ON] for [Parking Assist Guide].

⚠ WARNING

Parking Guide can not be adjusted while driving.

- Tap on  access into to adjust the parking guidelines.
- Adjust the parking guidelines by selecting the mark.



- Adjusting the position of the selected mark.



Make sure that (A) and (B) are horizontally parallel, and that (C) and (D) are the same length.

NOTE

- Rear camera must be connected to proceed to the Parking Guide configuration.
- Tap  to set all the marks to the initial default position.

Phone Devices

Tap  access into Phone Devices mode to set the below items:

◆ CarPlay Sidebar

Select the position of the control bar (Left or Right) shown on the touch panel. The default is "Left".

◆ Q&A

Tap on  access into study the Smart Phone connectivity help.

Bluetooth Settings

Tap  to display the Bluetooth settings mode, and tap on a setting repeatedly to change setting.

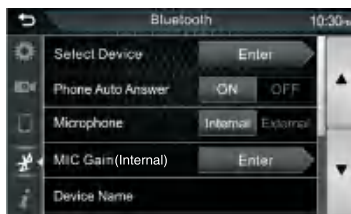

NOTE:

For detailed operation, please refer to "Bluetooth" on page 9.

Software Information

Tap  access into Software information mode to check the software version of this unit.

◆ Software Update

Using "AppUP+" smartphone APP for checking new version of software, and follow the setps to upgrade this device.

◆ Initialise

Tap  to restore factory default value.

12. 24Bit DSP AUDIO



Tap  to access into the Audio Settings Mode adjust the various settings.

◆ 13 Band Equalizer



◆ Time Alignment



- Tap  to adjust the delay time of the selected speaker
- Tap  to adjust the sound level of the selected speaker.

◆ Cross Over

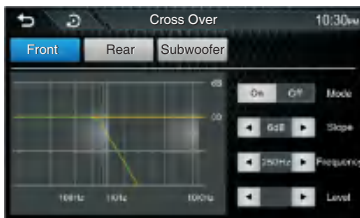

- Tap to set the virtual tweeter when you are selecting front speakers.
- Tap to switch Front/Rear high pass filter function
- Tap to switch Subwoofer low pass filter transfer function

◆ Fader/Balance



- **[Fader]:** Adjust the front and rear volume balance. 15(front) to 15(rear)
- **[Balance]:** Adjust the left and right volume balance. 15(right) to 15(left)

◆ Music Zone



- Select the preset listening zone to fit with perfect listening position

◆ Bass Boost



- **[Bass Boost]:** Set the amount of bass boost
- **[Loudness]:** Set the amount of boost of low and high tones

◆ Source Gain



- Finely adjust the volume of the current source to minimize the difference in volume between different sources.

13. TROUBLESHOOTING

GENERAL

Problem	Cause	Measure
Unit cannot power on.	Unit fuse blown.	Replace with new fuse of correct rating.
	Car battery fuse blown.	Replace with new fuse of correct rating.
No/low audio output.	Improper audio output connection.	Increase volume level.
	Volume set too low.	Replace with new fuse of correct rating.
	Speakers damaged.	Replace speakers.
	Heavily biased volume balance.	Adjust the channel balance to center position.
	Speaker wiring is in contact with metal part of car.	Insulate all speaker wiring connections.
Poor sound quality or distortion.	Speaker power rating does not match unit.	Replace speakers.
	Wrong connections.	Check wiring and correct.
	Speaker is shorted.	Check wiring and correct.
Unit resets itself when engine is off.	Incorrect connection between ACC and Battery.	Check the wiring and correct.

USB

Problem	Cause	Measure
USB device cannot be inserted.	The USB device has been inserted with wrong direction.	Reversing the connection direction of the USB device, try it again.
	The USB connector is broken	Replace with a new USB device.
USB device is not recognized.	The USB device is damaged.	Disconnect the USB device and reconnect. If the device is still not recognized, try replacing with a different USB device.
	Connectors are loose.	
No sound heard with the display "No File" shown.	No MP3/WMA file is stored in the USB device.	Store these files properly in the USB device.
Sound skips or is noisy.	MP3/WMA files are not encoded properly.	Use MP3/WMA files encoded properly.

Bluetooth

Problem	Cause	Measure
Cannot pair the Bluetooth enabled device with the audio system.	The device does not support the profiles required for the system.	Use another device to connect.
	The Bluetooth function of the device is not enabled.	Refer to the user manual of the device for how to enable the function.
The audio quality is poor after connection with a Bluetooth-enabled device.	The Bluetooth reception is poor.	Move the device closer to the audio system or remove any obstacle between the device and the system.

14. INSTALLATION AND CONNECTION WIRE

◆ Before Starting

1. This set is exclusively for use in vessels with a negative ground 12V power supply.
2. Read these instructions carefully.
3. Be sure to disconnect the battery “-” terminal before starting. This is to prevent short circuits during installation. (Figure 1)

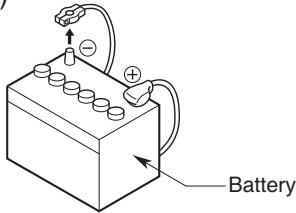
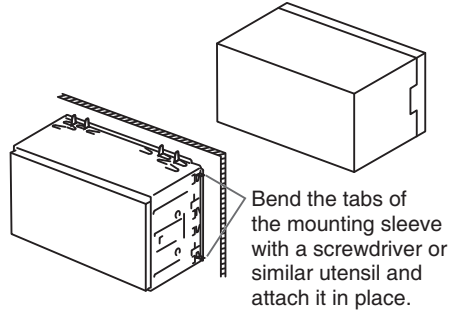

Figure 1

◆ General Cautions

1. Do not open the case. There are no user serviceable parts inside. If you drop anything into the unit during installation, consult your dealer or an authorized Clarion service center.
2. Use a soft, dry cloth to clean the case. Never use a rough cloth, thinner, benzene, or alcohol etc.
For tough dirt, apply a little cold or warm water to a soft cloth and wipe off the dirt gently.

◆ Installing the Unit



NOTE: Make sure that the unit is install securely in place. If the unit is unstable, it may malfunction.

◆ Trim Ring Installing

Attach accessory ② to the unit.

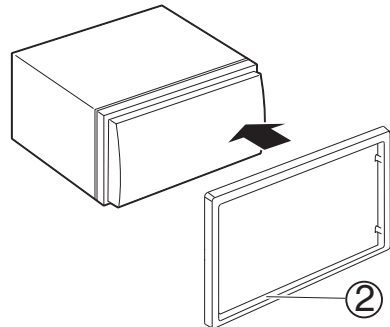

14. INSTALLATION AND CONNECTION WIRE

◆ Wiring and Connections

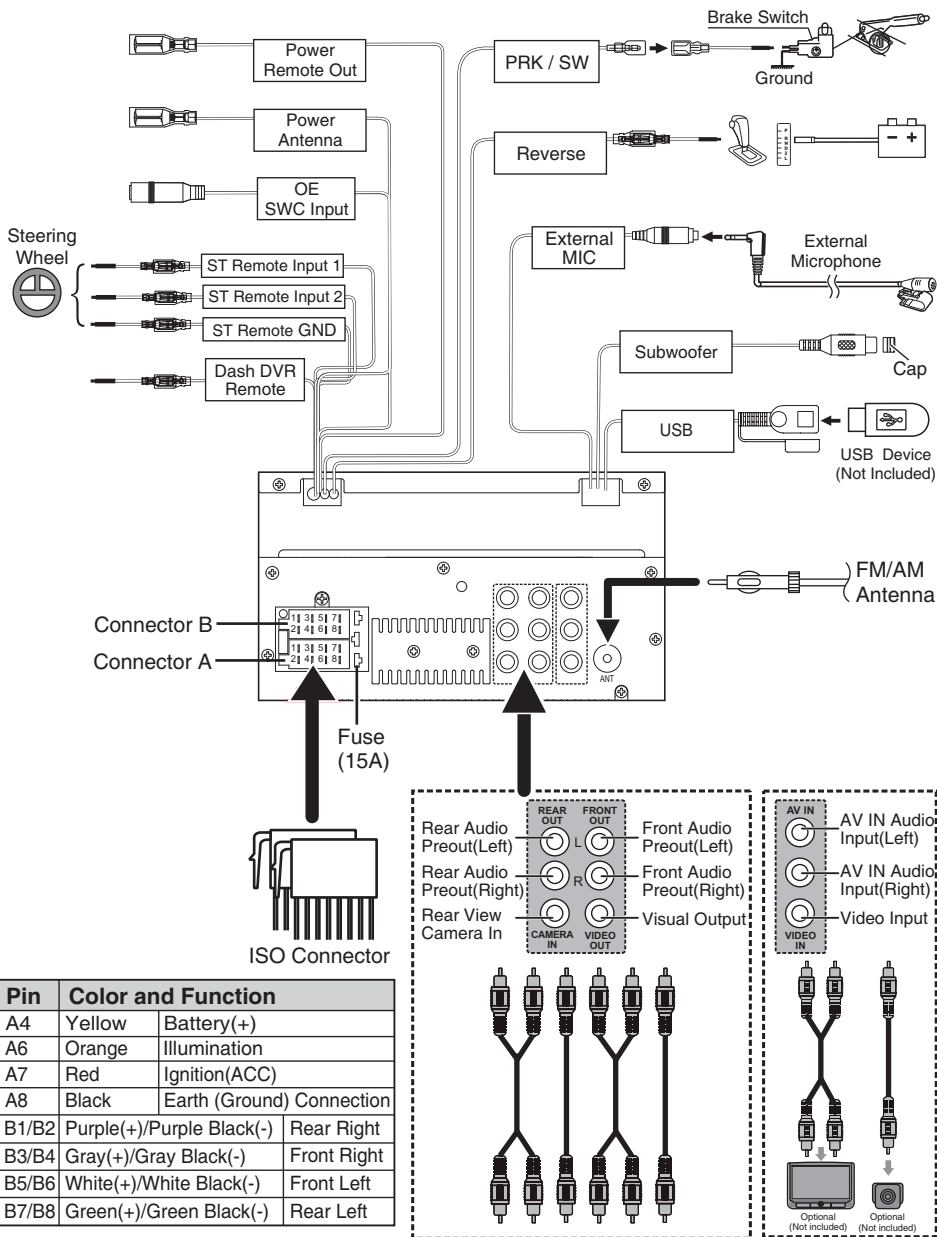

15. SPECIFICATIONS

Monitor section

Screen Size	6.8 Inches
Display Resolution	800x480 dots

USB interface section

USB Standard	USB 2.0 High Speed
File System	FAT 16/32
Maximum Current	DC 5 V $\overline{=}$ 1.5A
D/A Converter	24 bit

Bluetooth section

Communication System	Bluetooth Ver 4.1
Output	Bluetooth Standard Power Class 1
Maximum Communication Range	Approx. 10meters
Frequency Band	2.4 GHz
Compatible Bluetooth Profiles	HFP/SPP/A2DP/AVRCP
Supported Codecs	/PBAP SBC (Sub Band Codec)

Radio section

Frequency FM Range	87.5-108MHz 76.1-107.9MHz
Frequency AM Range	530-1710KHz
Usable sensitivity	13.2 μ V (FM) 44.7 μ V (AM)(MW)

Video section

Color System of External Video Input	NTSC/PAL
External Video Input (RCA/3.5m Jack)	1 Vp-p /75 Ω

Audio section

Maximum Power	50Wx4
Continuous Power Output (RMS)	22Wx4
Preout Level (V)	3V/10k Ω
Preout Impedance	\leq 1.3k Ω
Speaker Impedance	4-8 Ω
Output Frequency Band	20-20000Hz

General

Operating Voltage	14.4V(9 ~ 16 V)
Operational Temperature Range	-20° C ~ +80° C
Maximum Current Consumption	15A

Support Formats

Support Audio Formats

- MP3/WMA/WAV/FLAC
- WMA Version V9 or earlier
- ID3 Tag Version 1/2.2/2.3/2.4

Support Video Formats

- MPEG 1 (.mpg,mpeg), 720x480(30fps)
- MPEG 2 (.mpg,mpeg), 720x480(30fps)
- MPEG 4 (.mp4,avi), 1280x720(30fps)

Support File / Folder Formats

- Directory nesting up to a maximum of 8 levels
- Number of tracks/titles: maximum 999
- Number of albums/folders:maximum 99

Clarion Co., Ltd.

Copyright © 2020 Clarion Co., Ltd.
Printed in China