

Installation Guide

Part No: **FP8228K** BMW Can-Bus Steering Wheel Control Interface

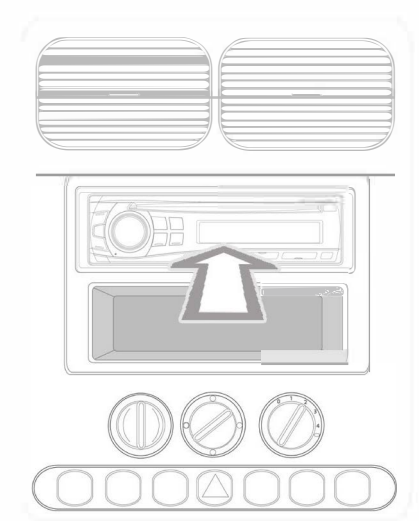
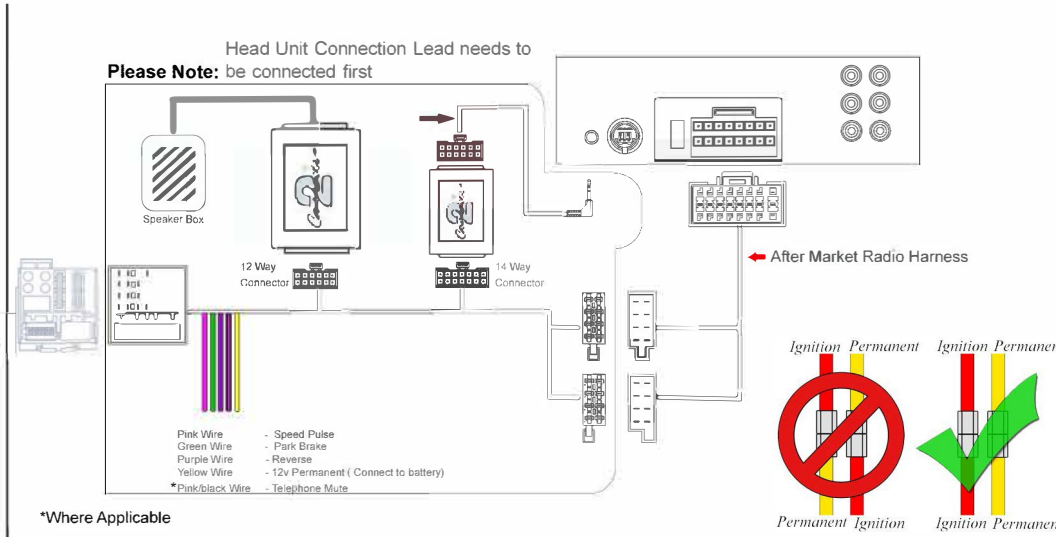
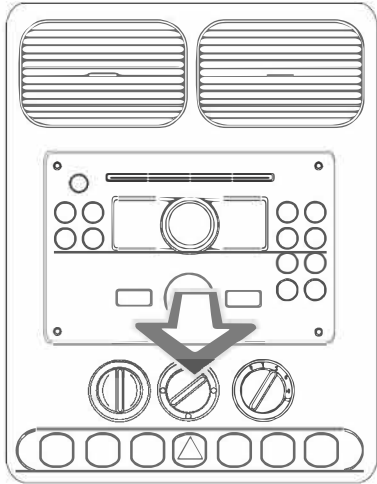

Vehicle Compatibility:

For Vehicle Compatibility visit <https://aerpro.com/FP8228K>

Steering Wheel Control Functions

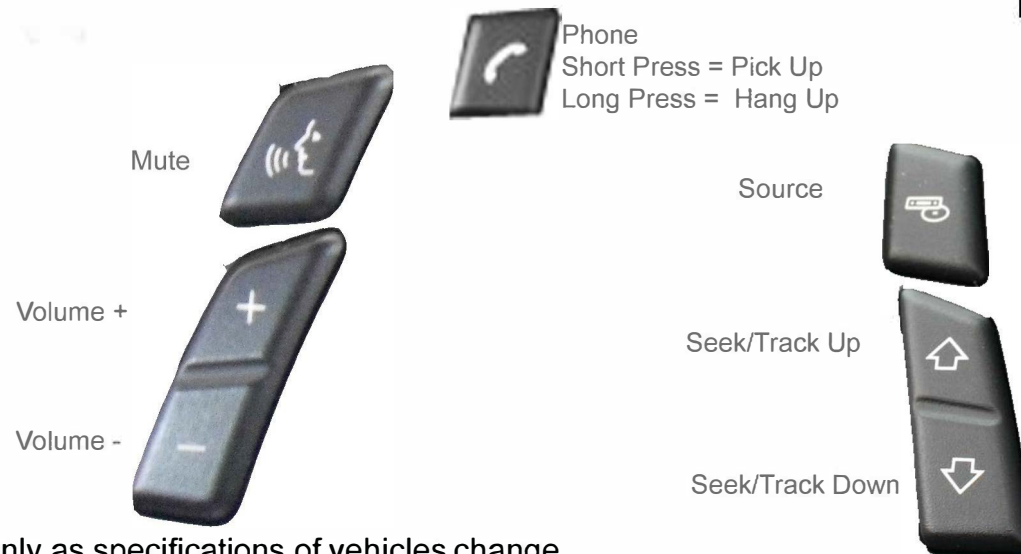

Note for Installing a Sony head unit
Disconnect the interface from the vehicle. Open the interface box and ensure dipswitch 4 on the PCB is set to **off**.



* Note All Dates are guide lines only as specifications of vehicles change



1. BMW 1 (E87) 03/2007 (facelift) with switch bar under the climate control unit

BMW without switch panel under climate control unit (see left)

- see note on page 7

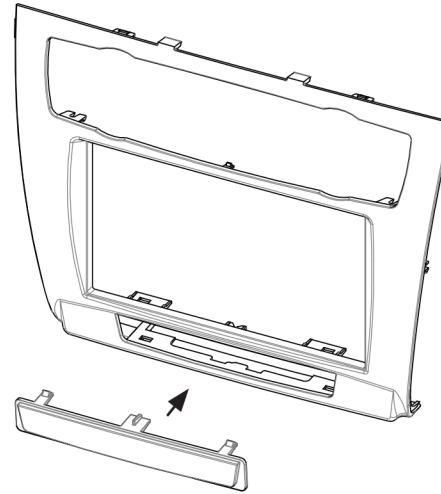

Note:

Only for BMW without switch panel under climate control unit:

Attach blanking cover to fascia plate (see arrow)



2. Unclip middle panel and remove it carefully



3. Unclip air condition control unit

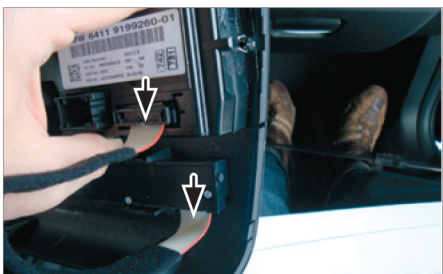

4. Pull out air condition control unit carefully

Remove pulgs (see arrows)

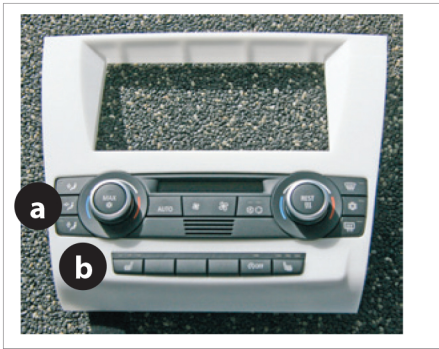

10. Attach air condition control unit (a) and switch bar (b) to replacement fascia plate

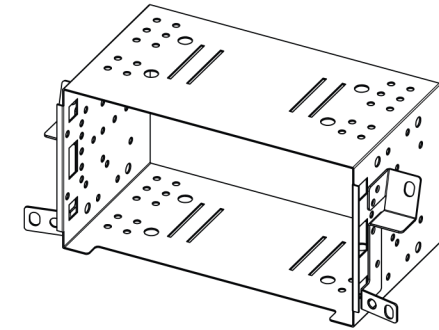

11. Set metal frame into dashboard and fix it with screws

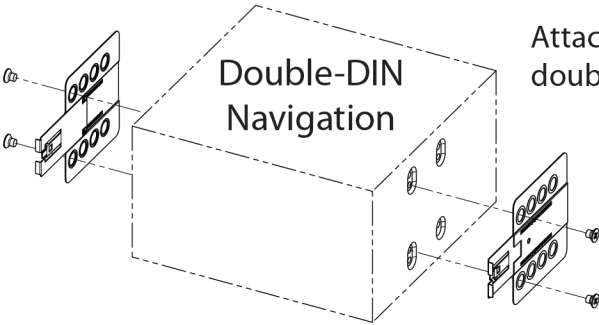

Attach mounting brackets to double DIN navigation



12. Connect all required circuit points

Push double DIN navigation into dash board - until it snaps in

Reinstall everything in reverse order to finish installation

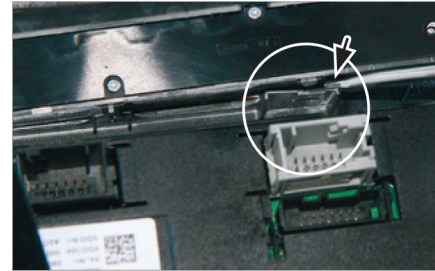

5. Unclip and remove switch panel below air condition control unit



6. Unclip and remove air condition control unit

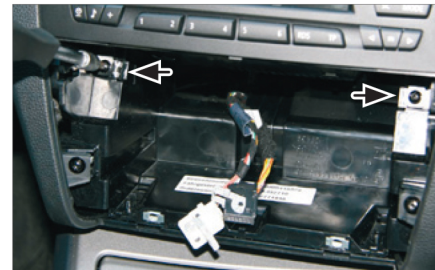
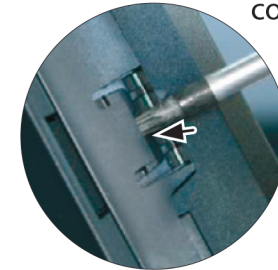

7. Remove screws below OEM head unit (see arrows)

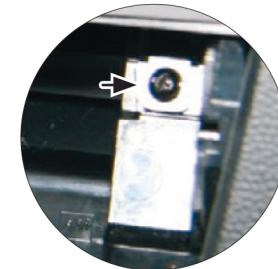

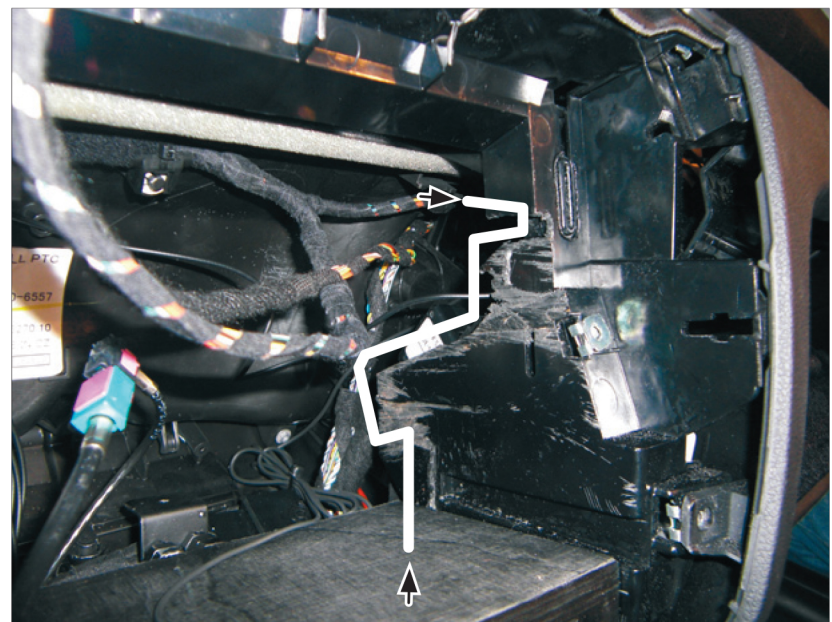
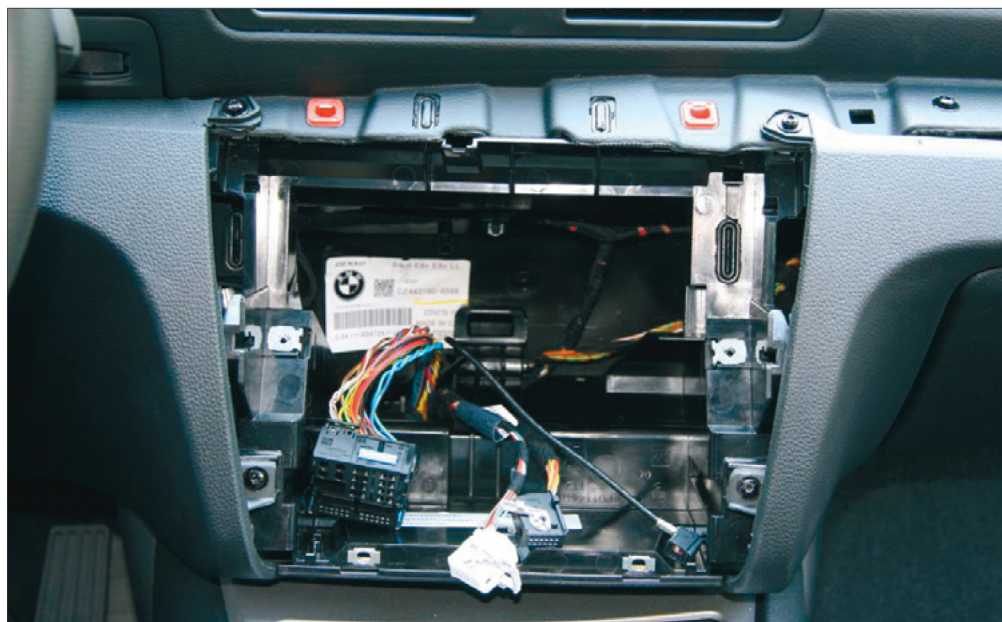
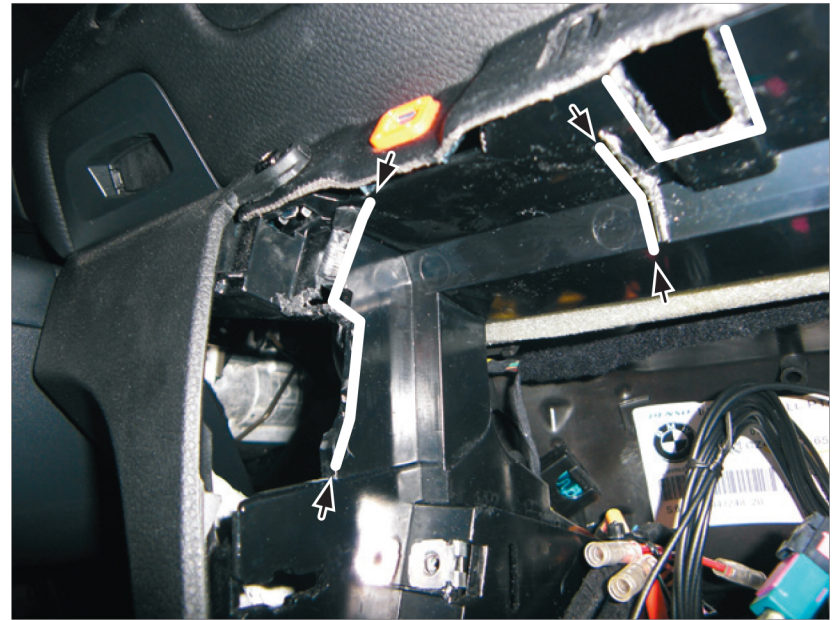

8. Remove out OEM head unit

9. Cut away plastic to clear space for Double DIN head unit (see sample images)