



VW up! 2011-2016*

Part Number.
FP8435
FP8436

Colour
black
piano black

* Only for models with manual air conditioning and glove box

pos. designation

- (1) facia plate
- (2) mounting bracket right
- (3) mounting bracket left
- (4) mounting frame
- (5) facia climate control
- (6) connection piece ahead
- (7) template
- (8) mounting bracket complete
- (9) washer
- (10) flat-head screw (M5x8)
- (11) self-tapping screw with collar

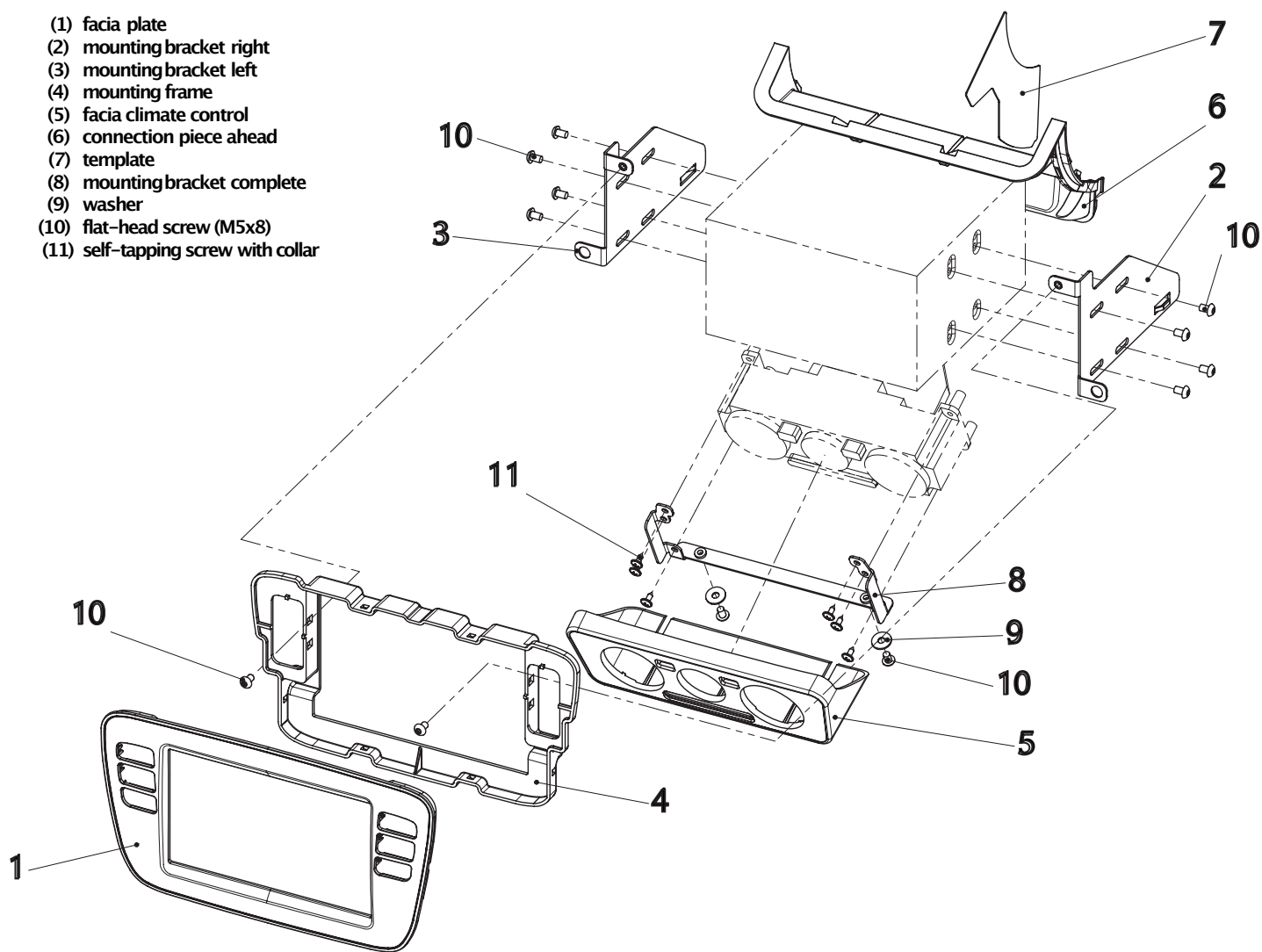



OEM dashboard SEAT Mii / SKODA CITIGO / VW up! with manual air conditioning







Remove 4 TX20 screws (screws will be required for reassembly)

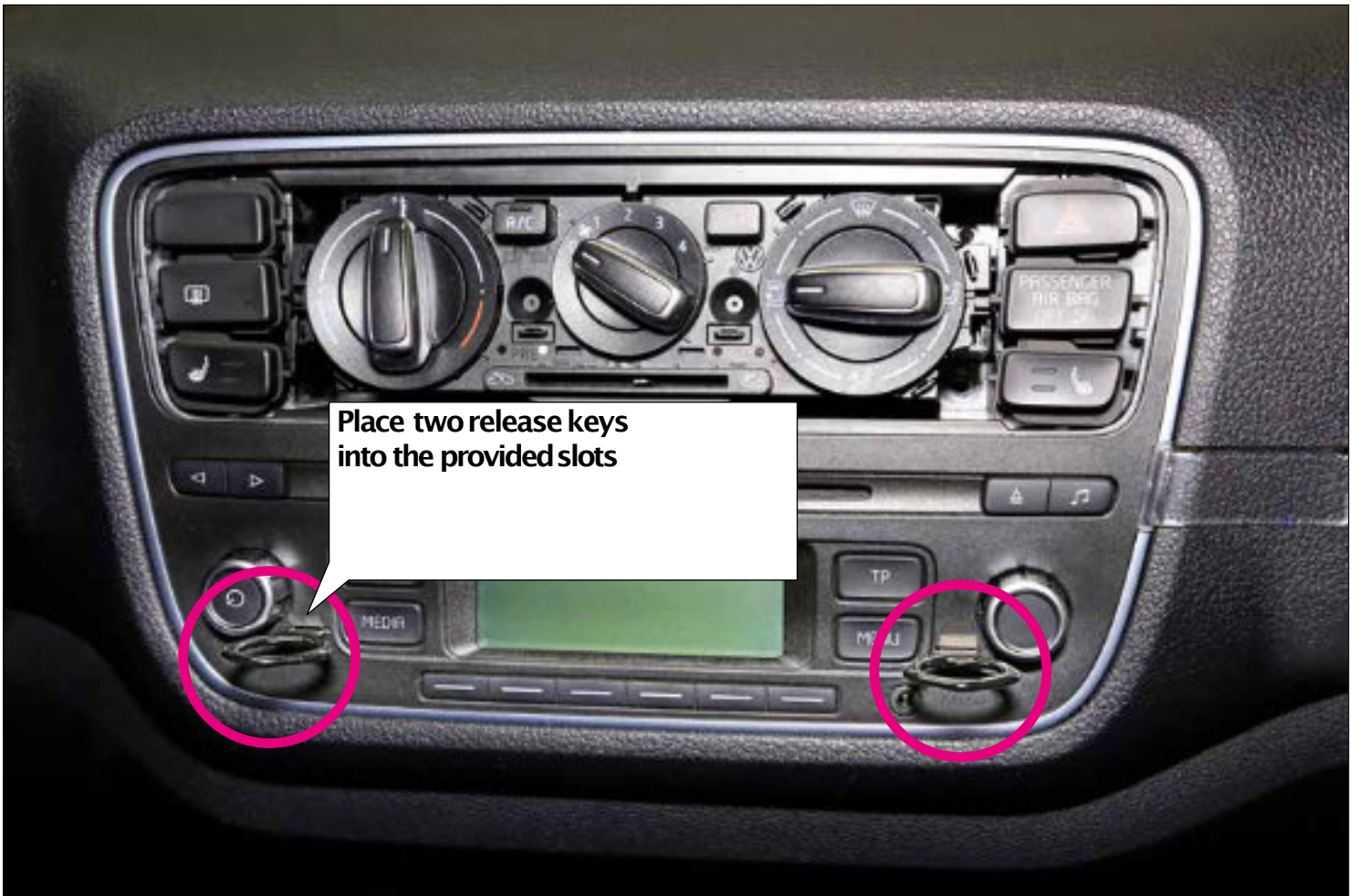

Place two release keys into the provided slots

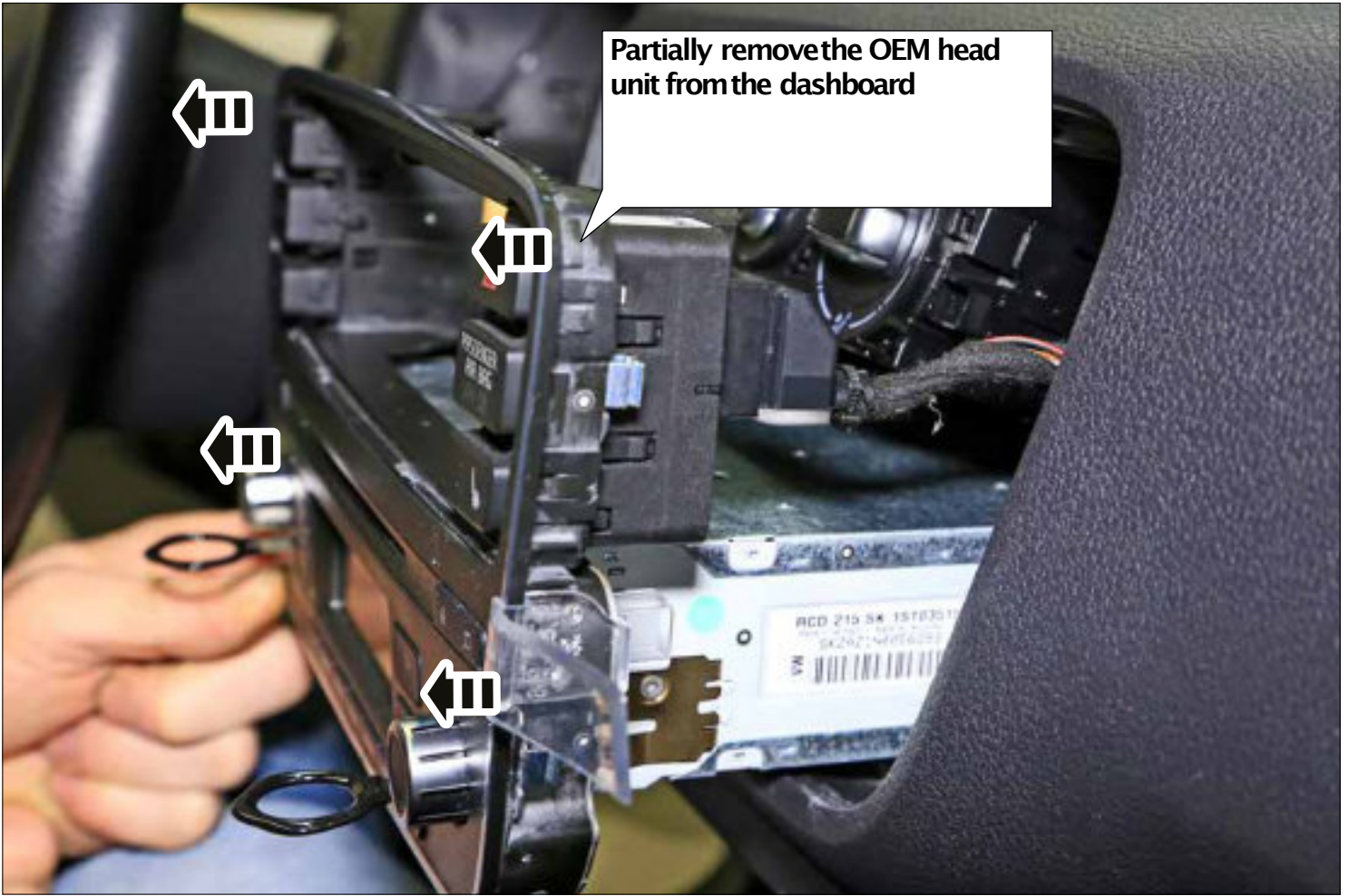







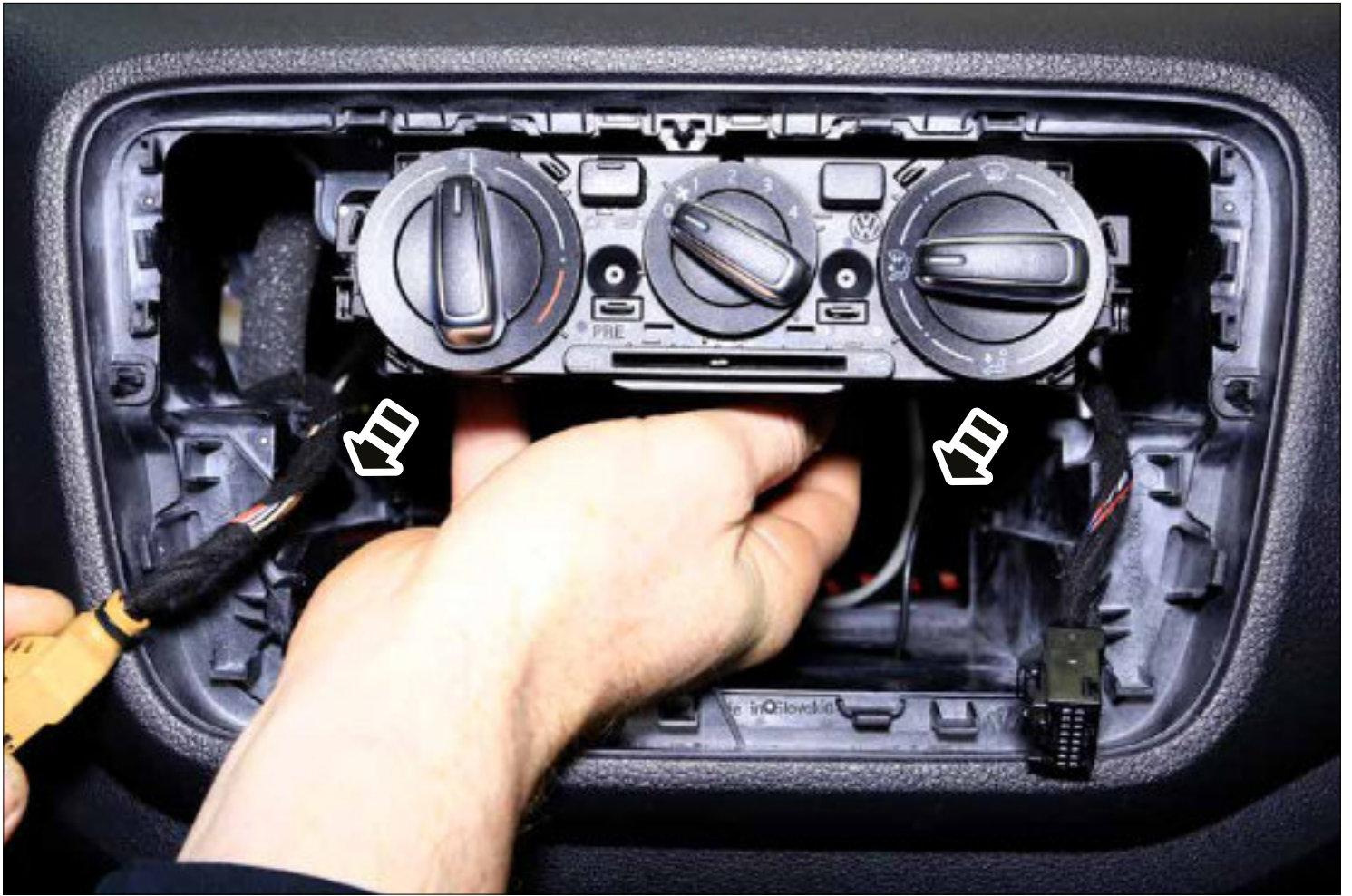

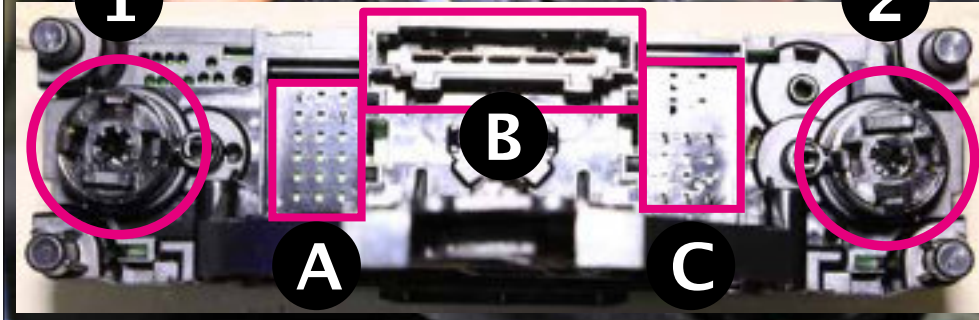
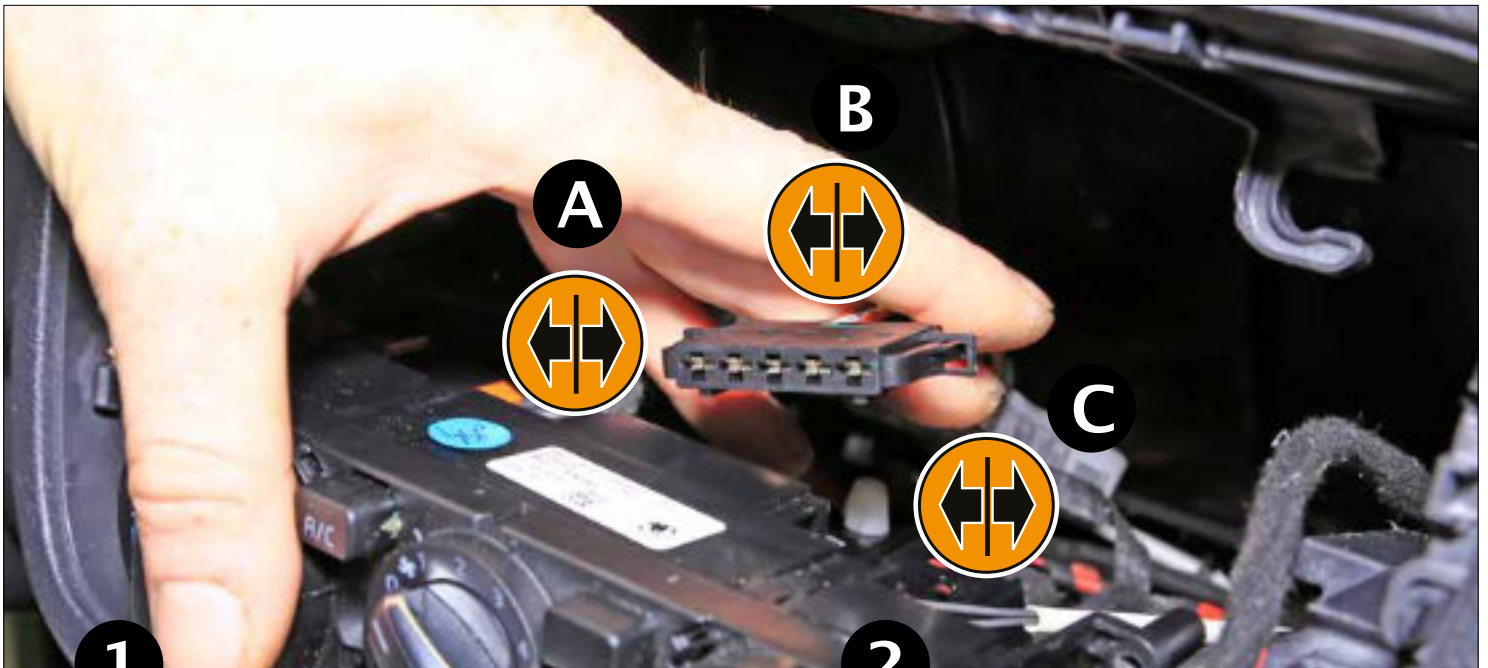

Pull 3 plugs and 2 Bowden cables out of the air conditioning control panel

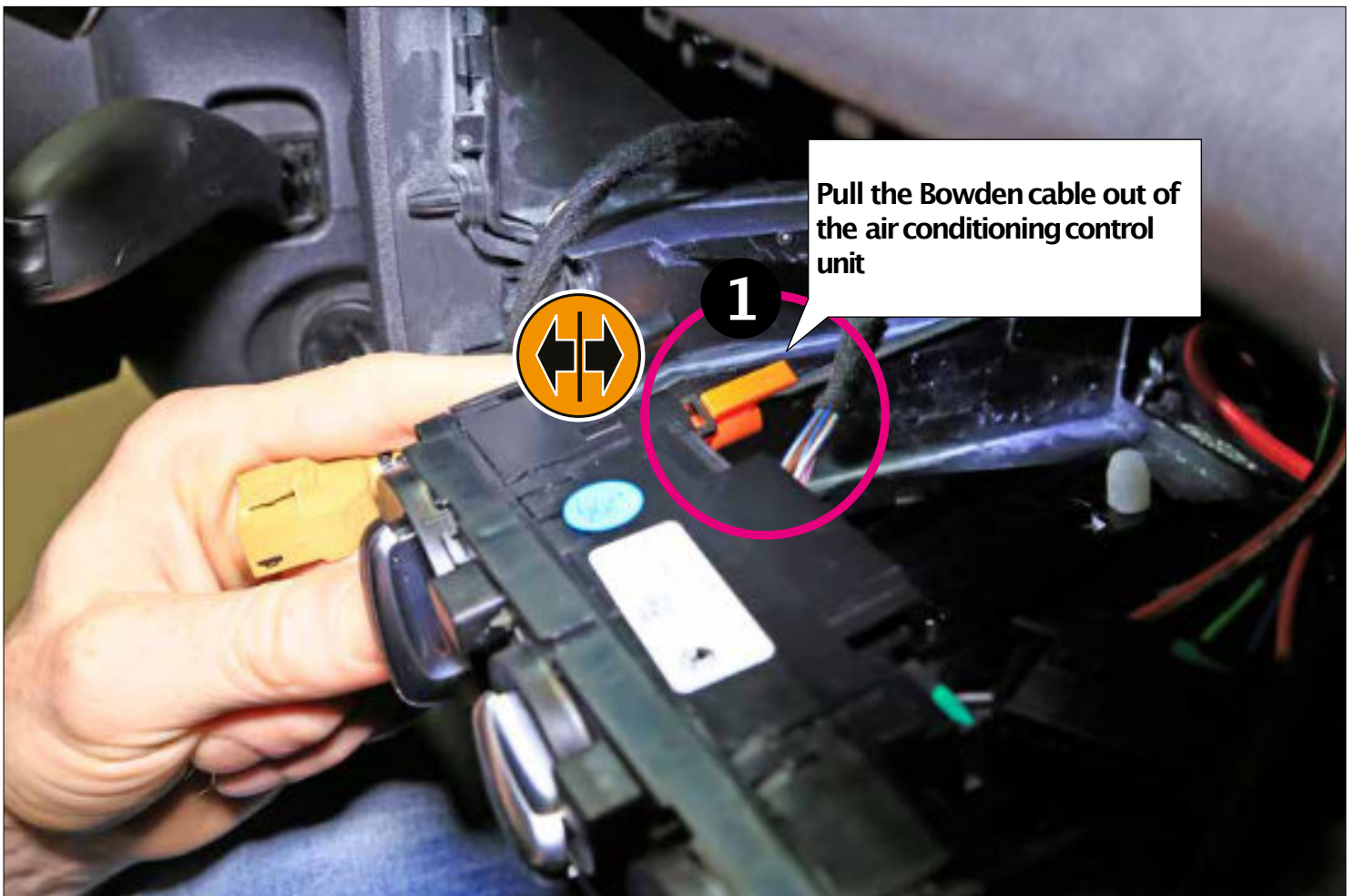

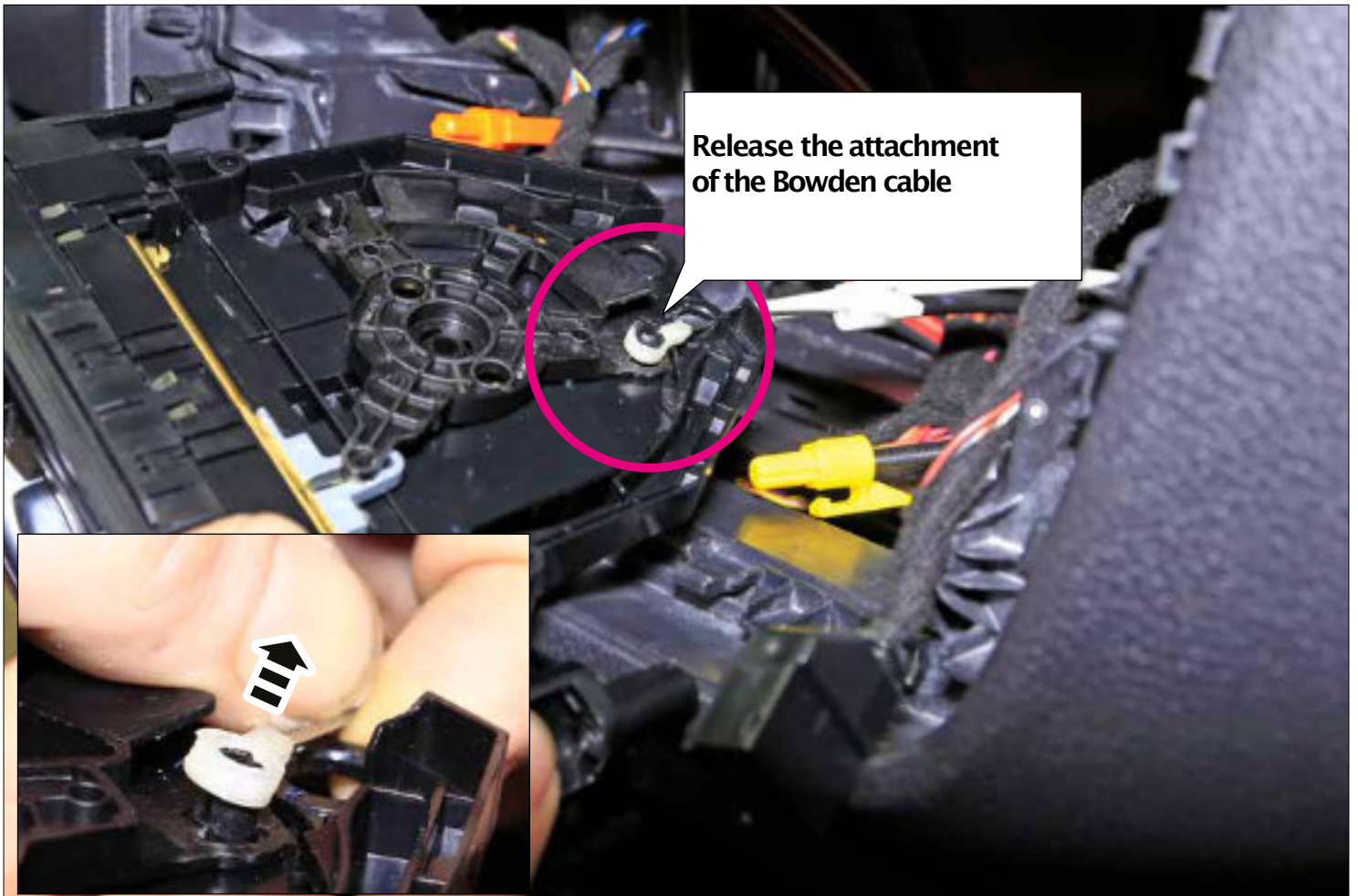
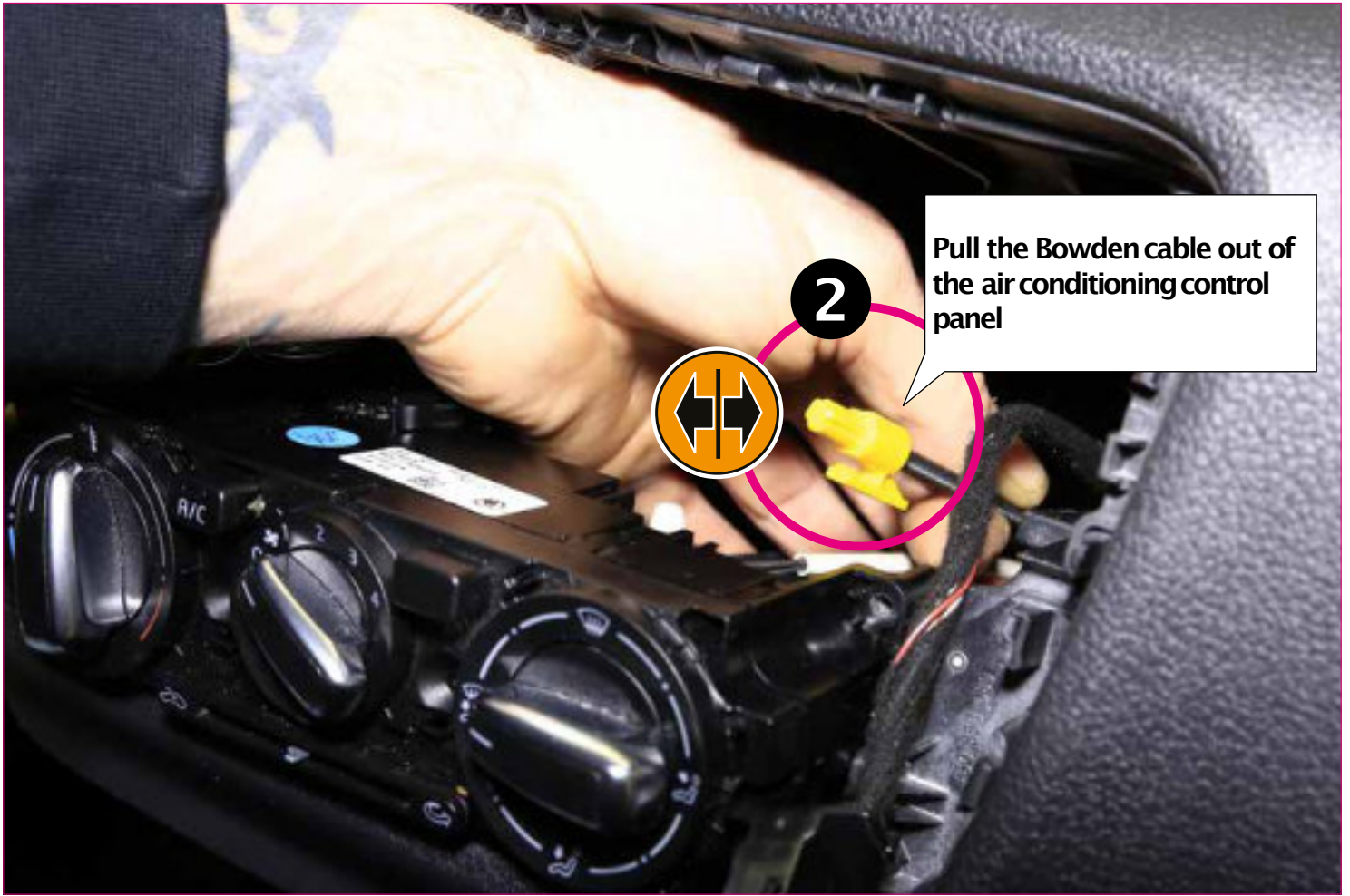





Place the panel on a flat surface

Place the fascia (5) of the air conditioning control unit centred onto the panel

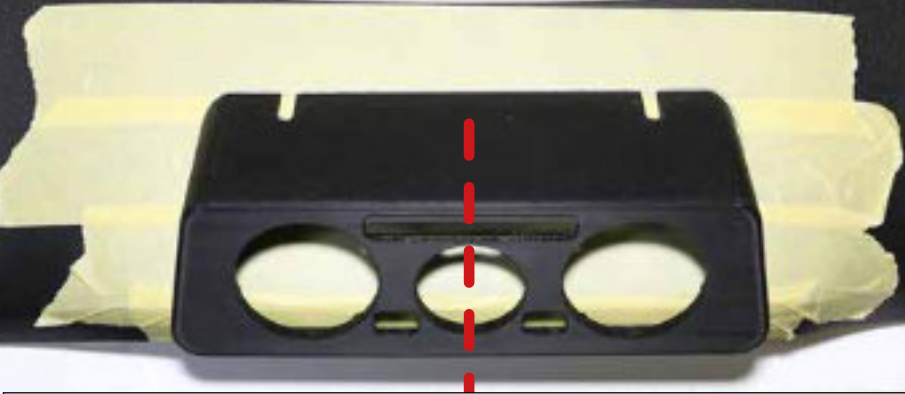

Draw an outline, using the fascia (5) of the air conditioning control unit as template

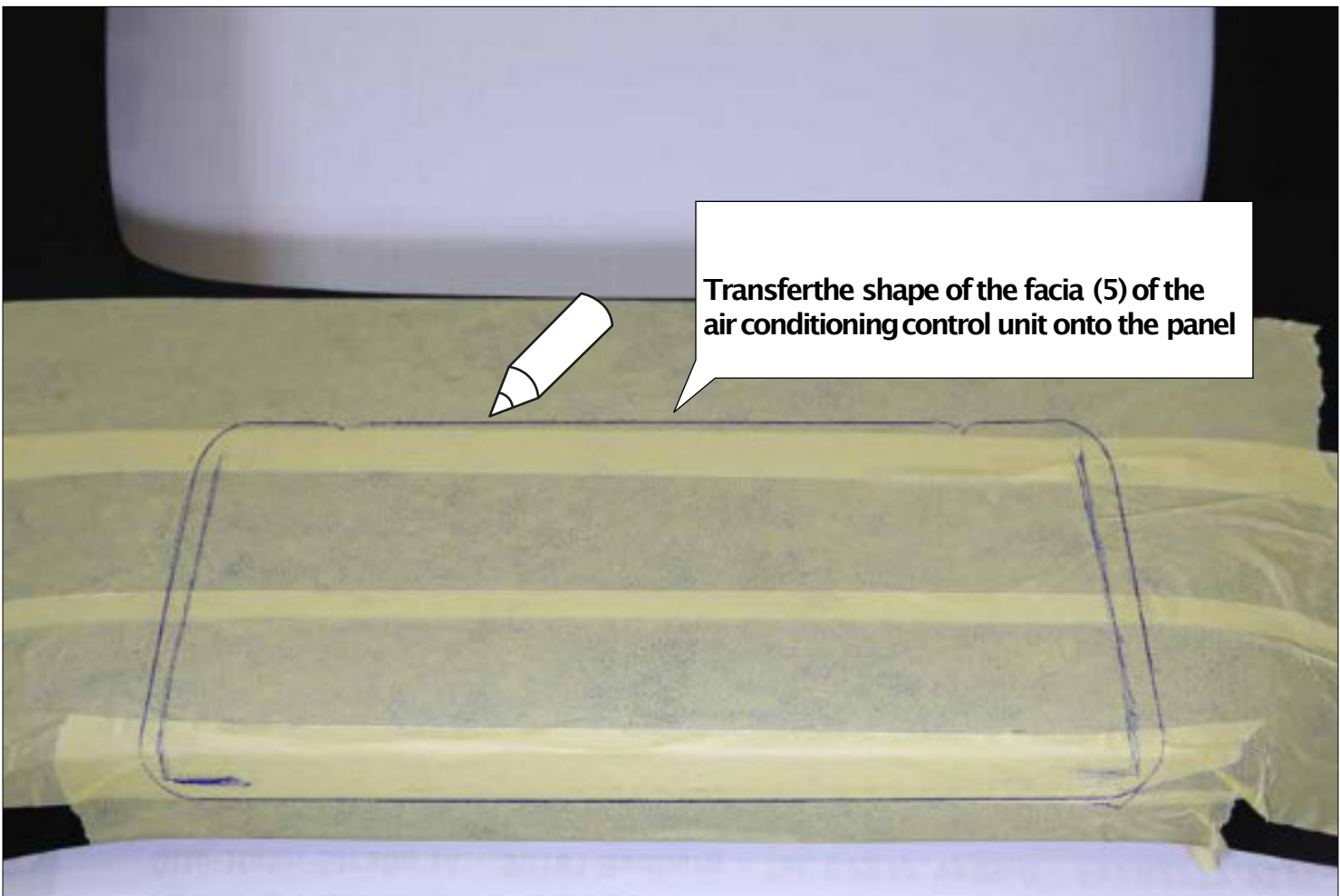

Transfer the shape of the fascia (5) of the air conditioning control unit onto the panel

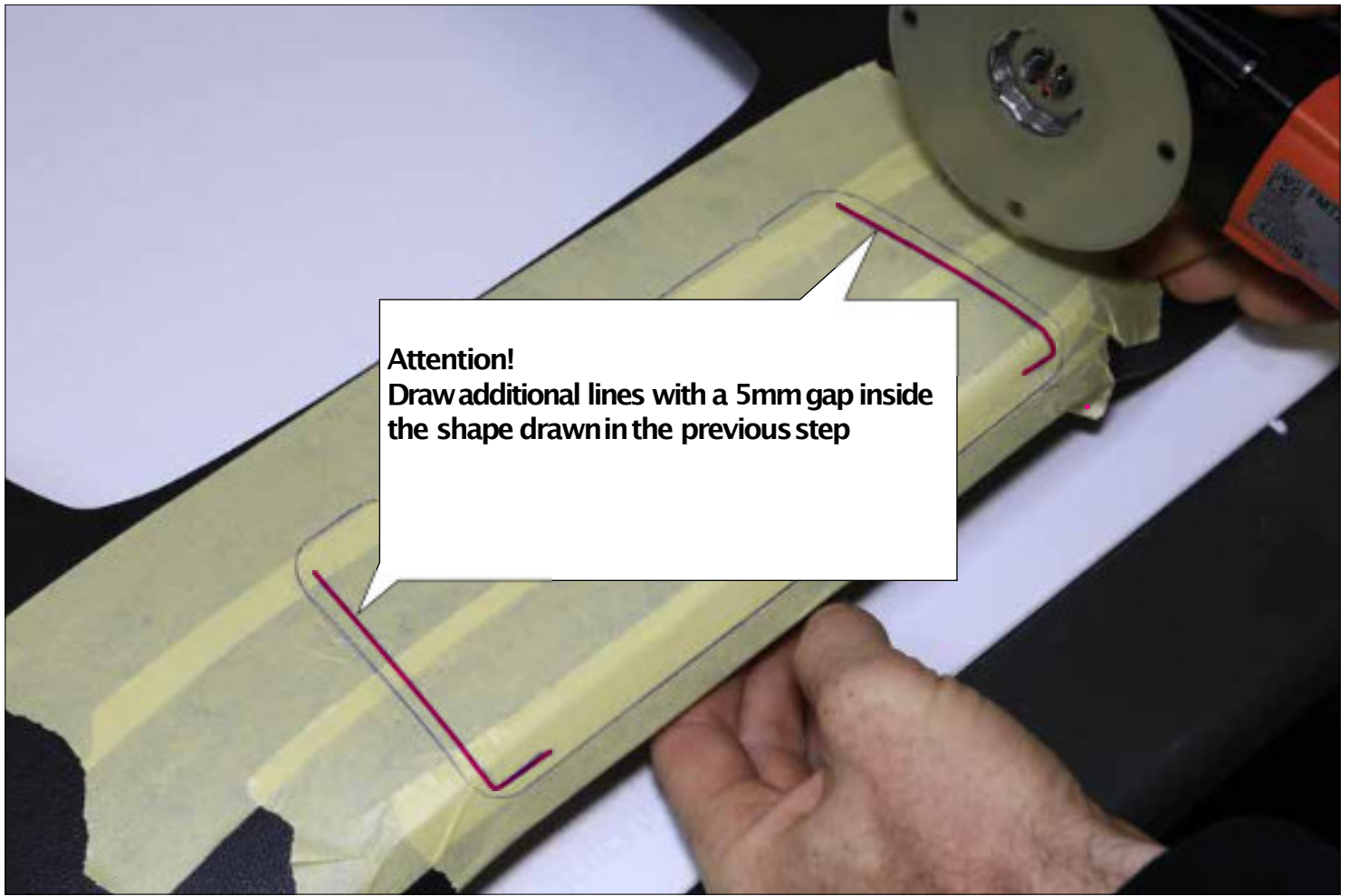

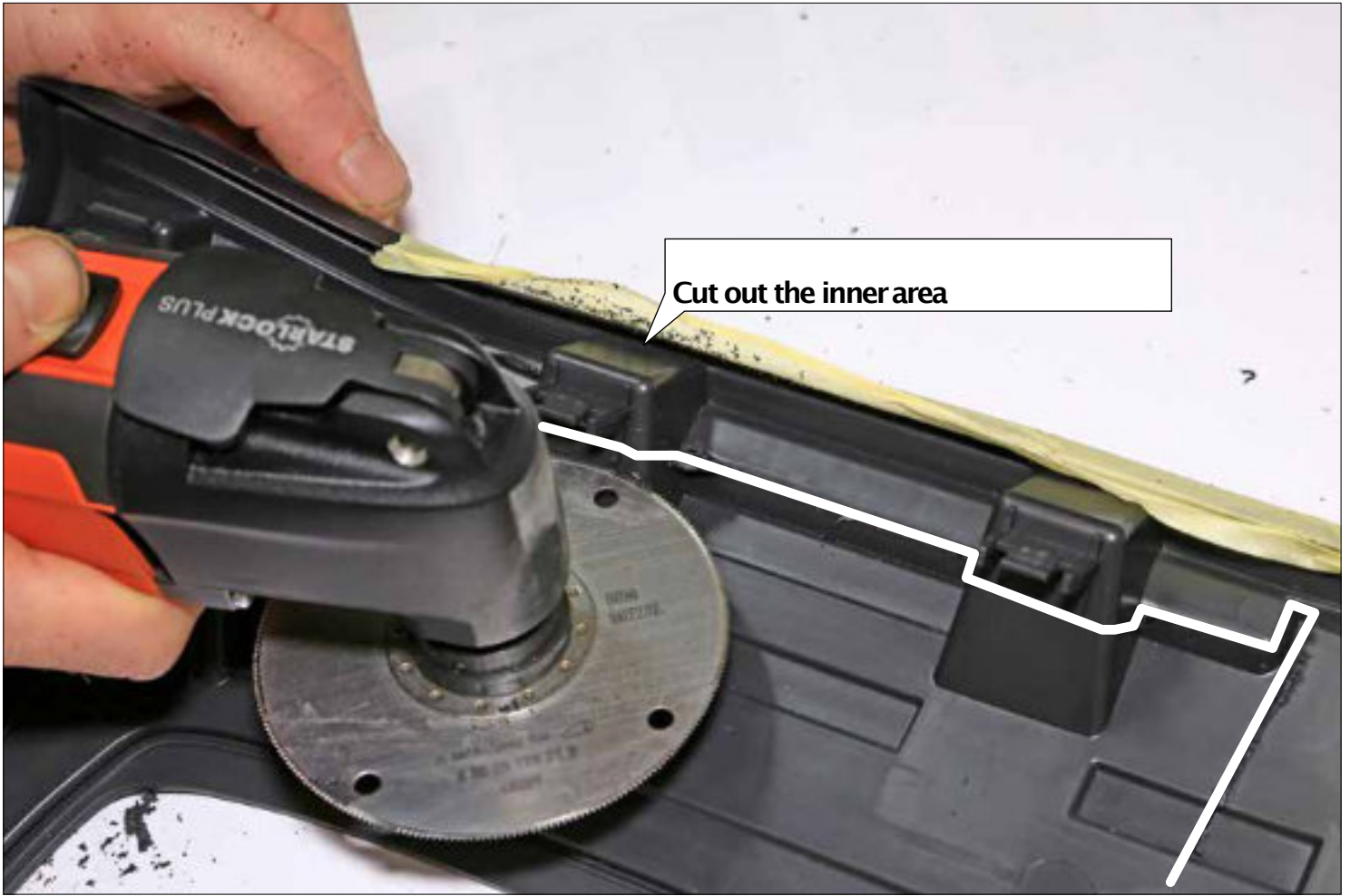

See below for an image of the removed section

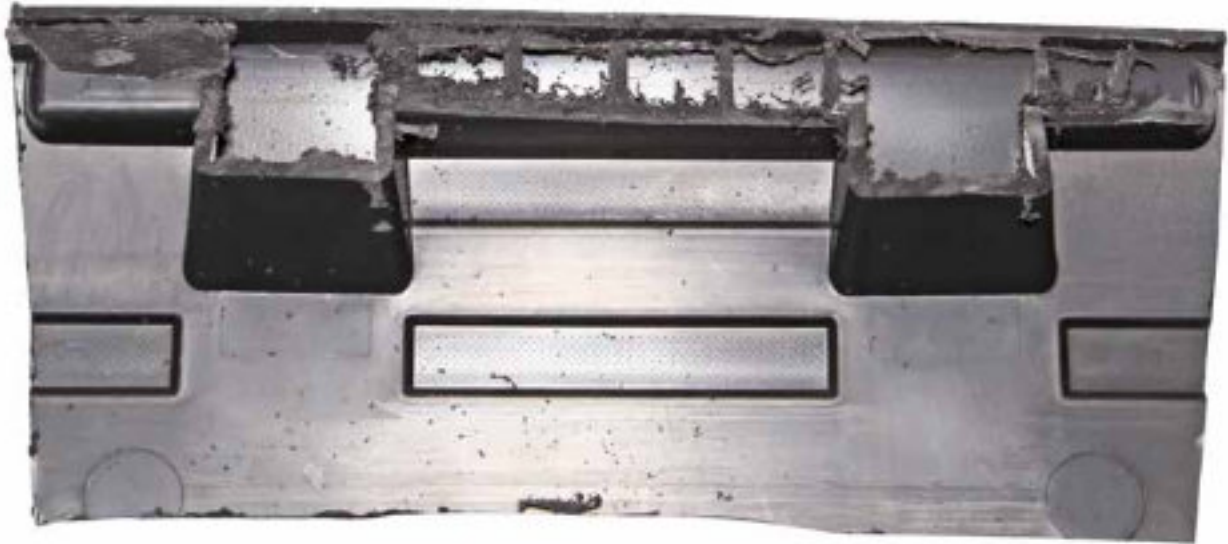

Remove all rough edges with sandpaper



Centre console panel after modification



If a double DIN head unit without CD/DVDdrive (mechless unit / maximal install depth 140 mm) is going to be installed, the removal of the OEM air channel is not necessary: Please proceed to page 20.





Cut out the marked areas



Cut out the marked areas

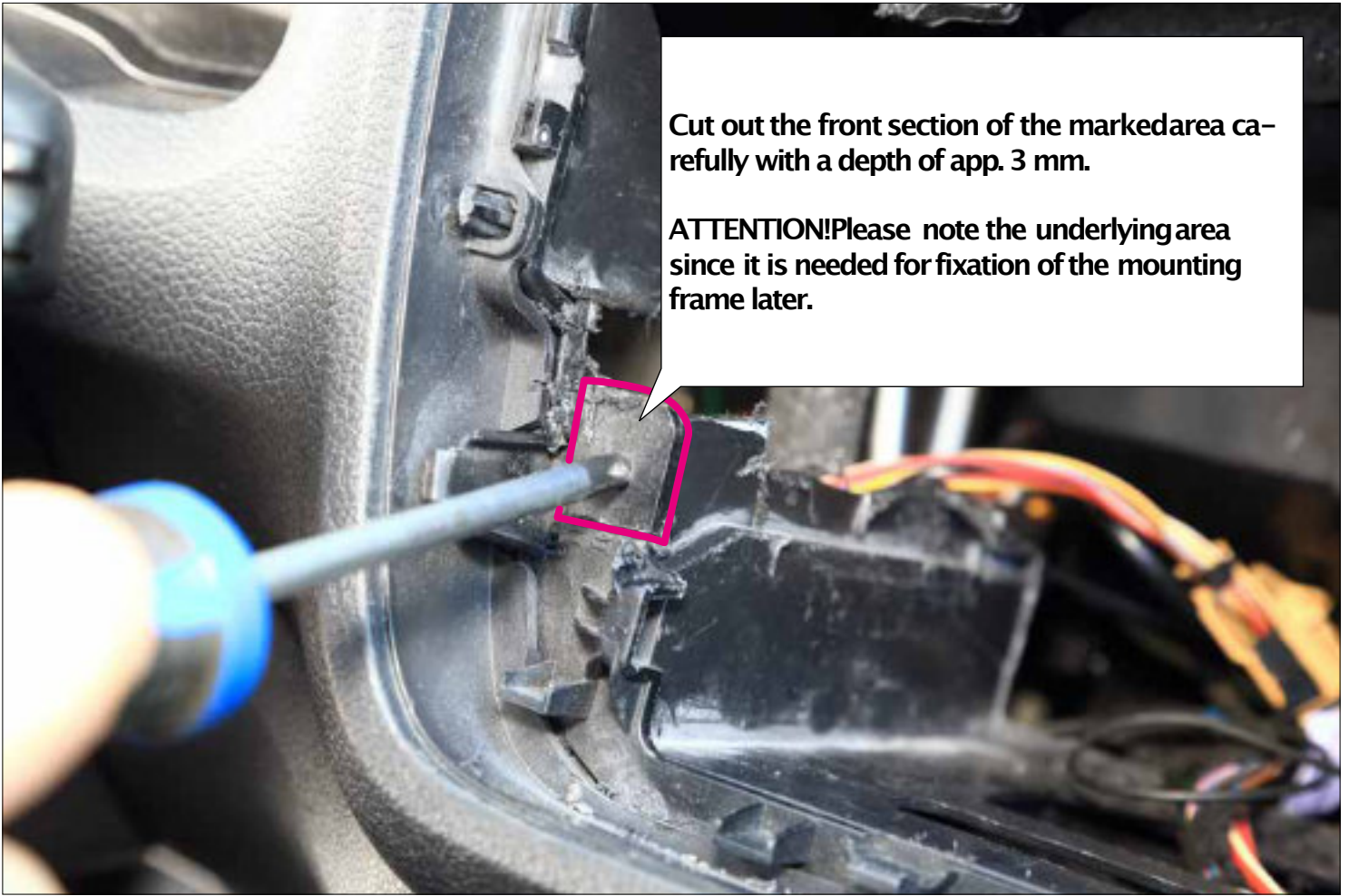

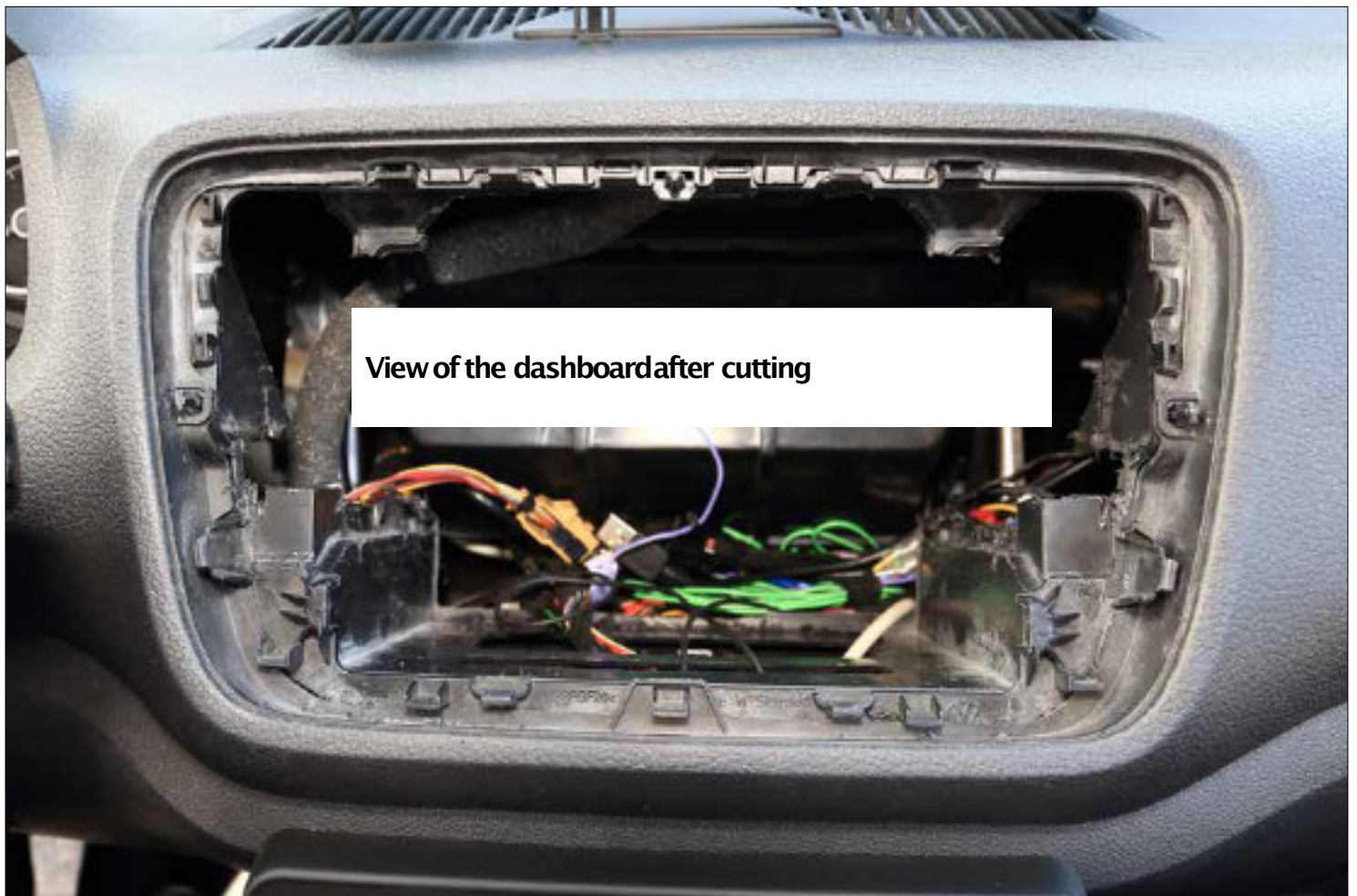
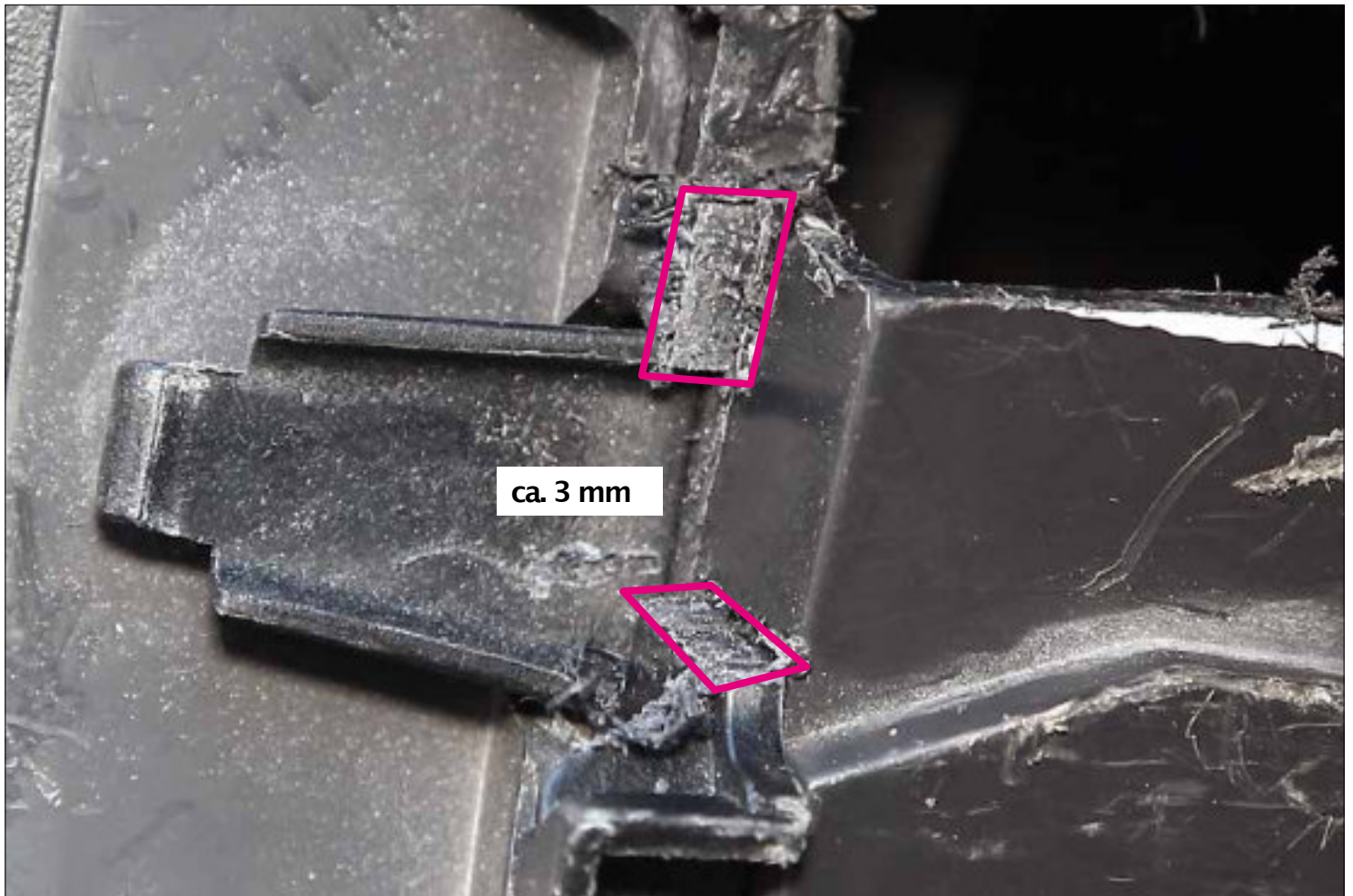

Fix the mounting frame (8).
Mark the areas inside the mounting frame

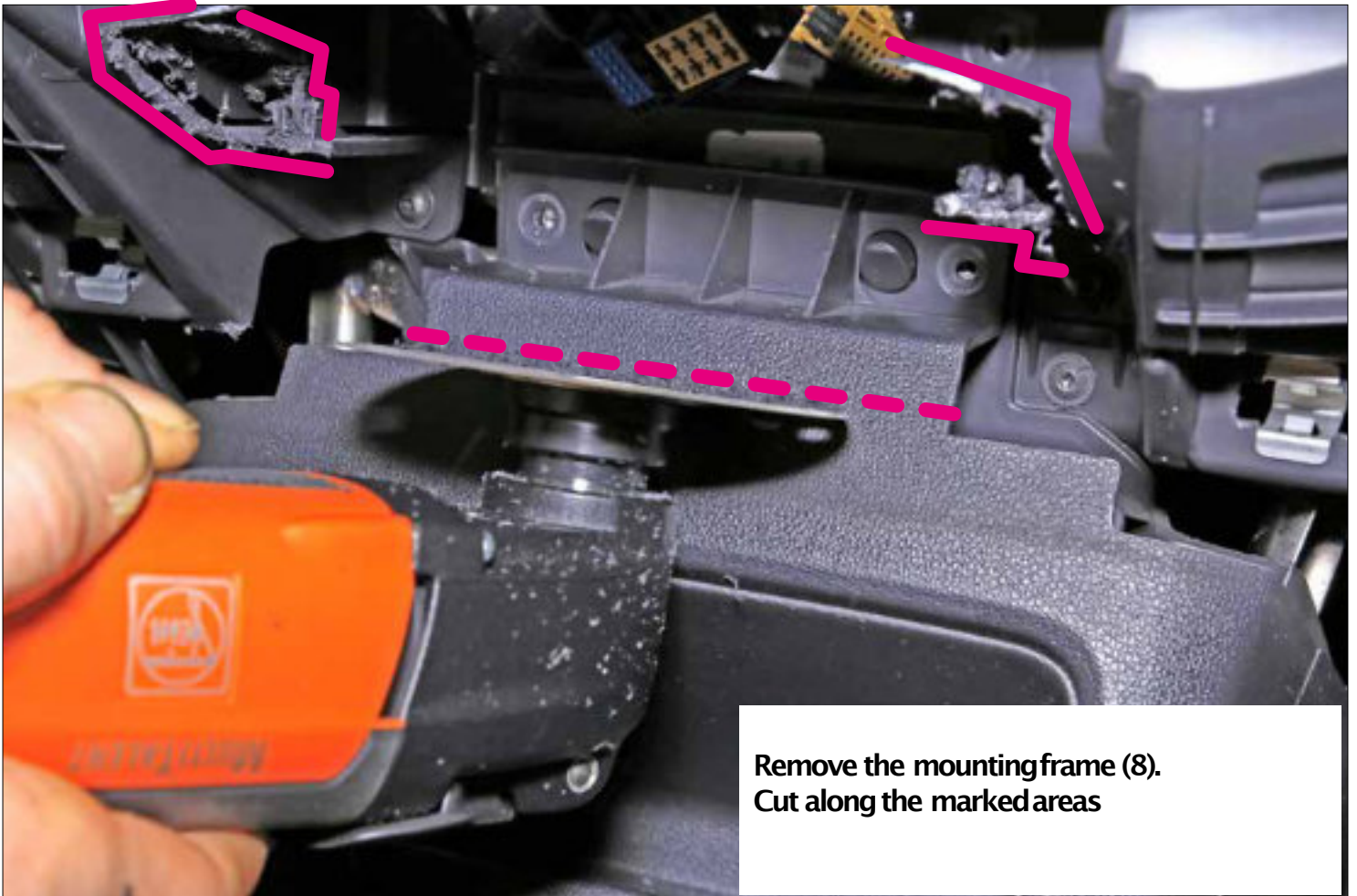

Remove the mounting frame (8).
Cut along the marked areas



Fix the mounting frame (pos. 8) with the air condition control unit with 4 self-tapping screws with collar (pos. 11)

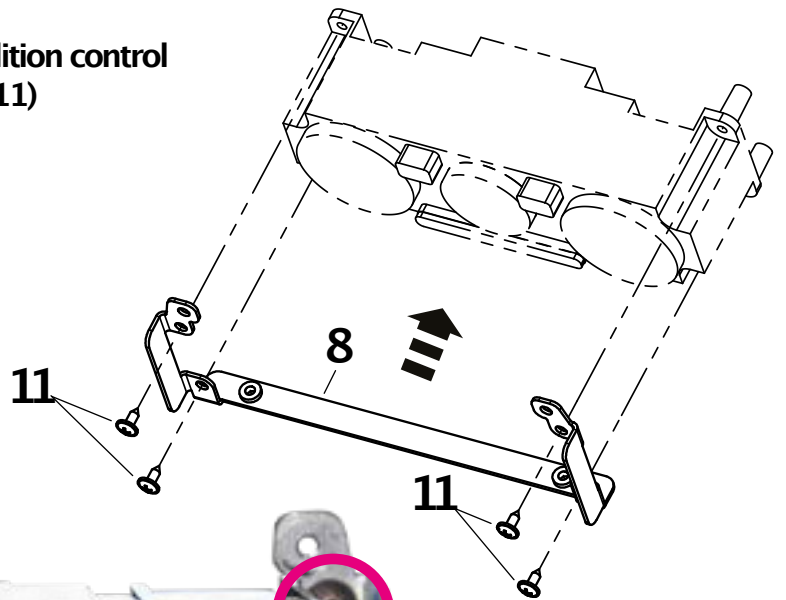

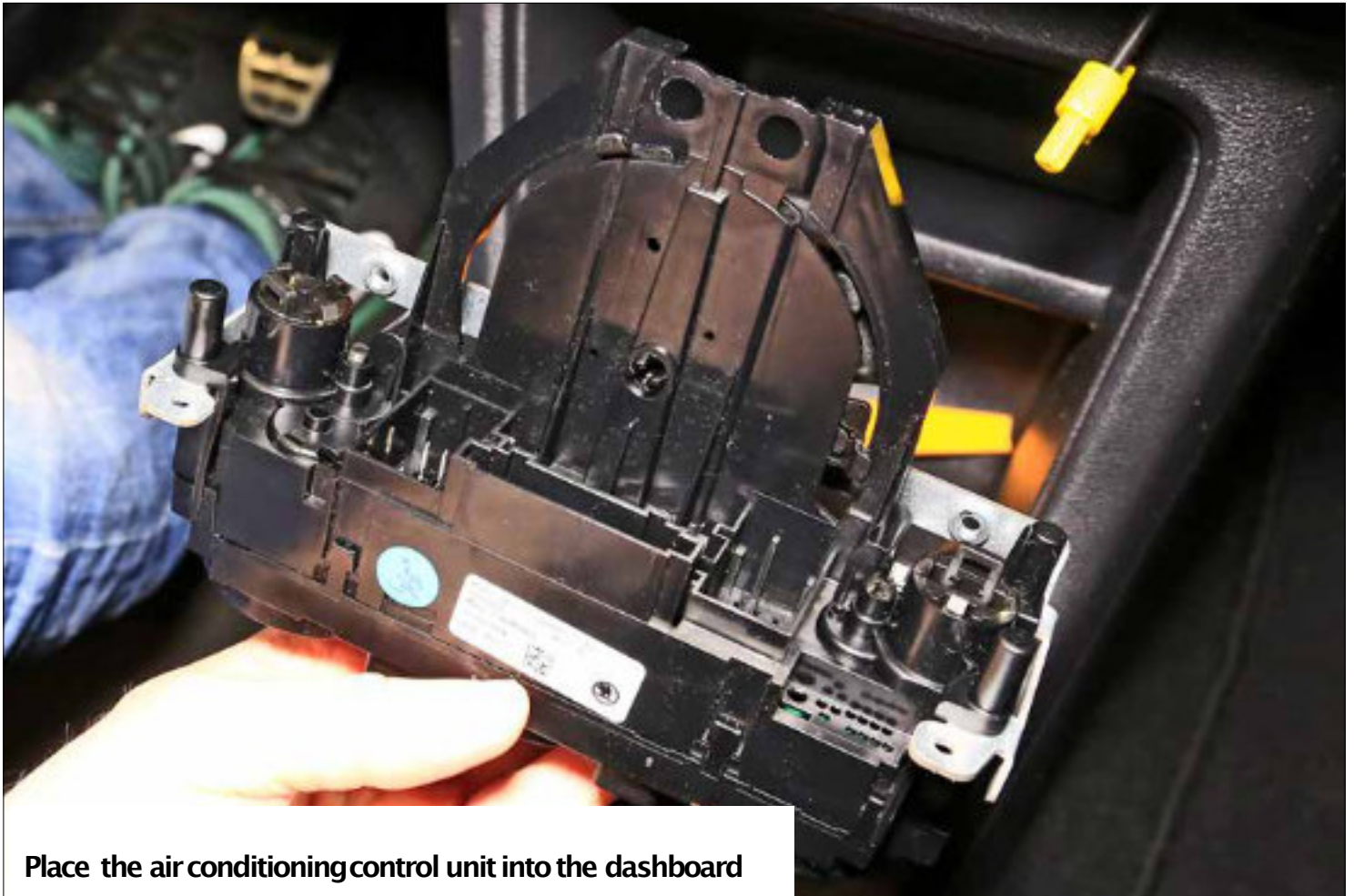

Place the air conditioning control unit into the dashboard

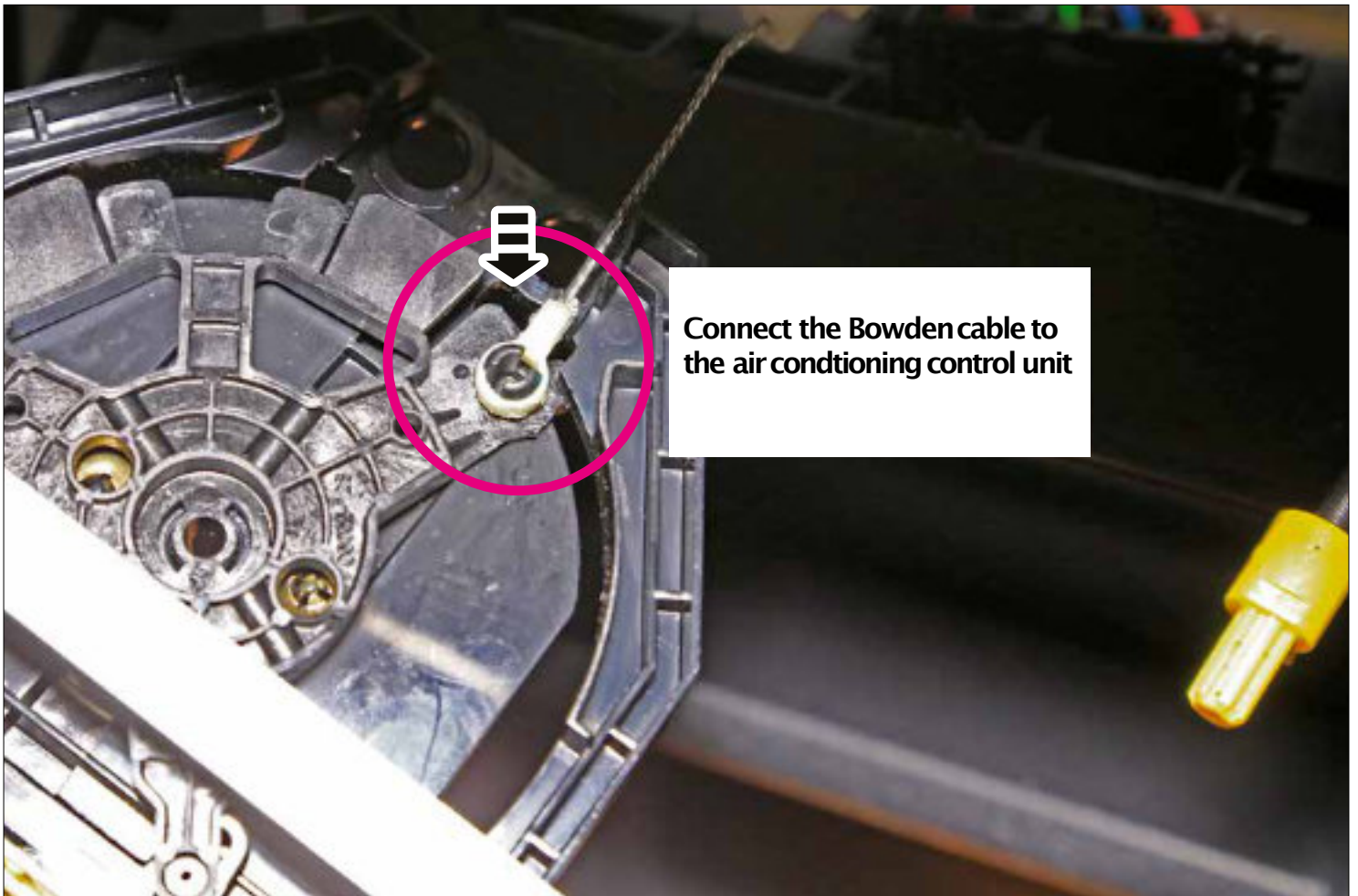

Connect the Bowden cable to the air conditioning control unit

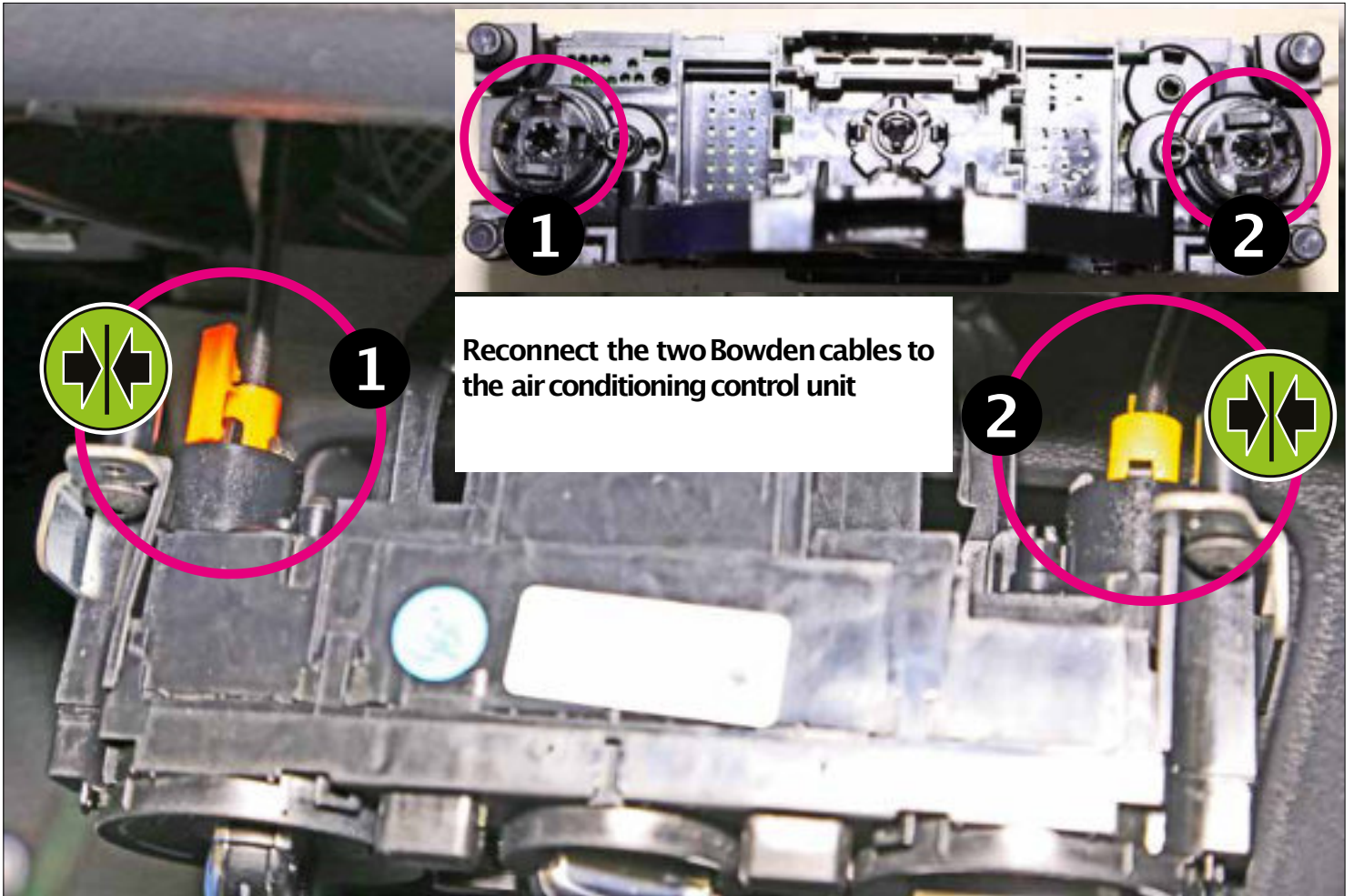

1
2

Reconnect the two Bowden cables to the air conditioning control unit

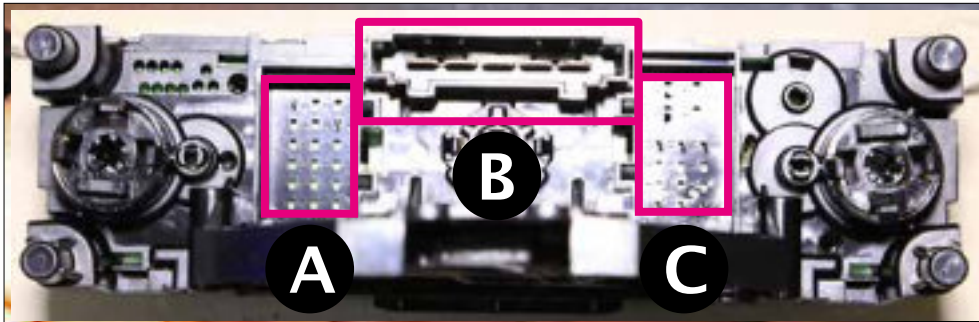
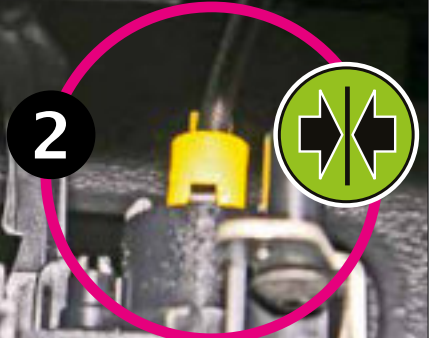

Reconnect the 3 OEM plug to the air conditioning control unit

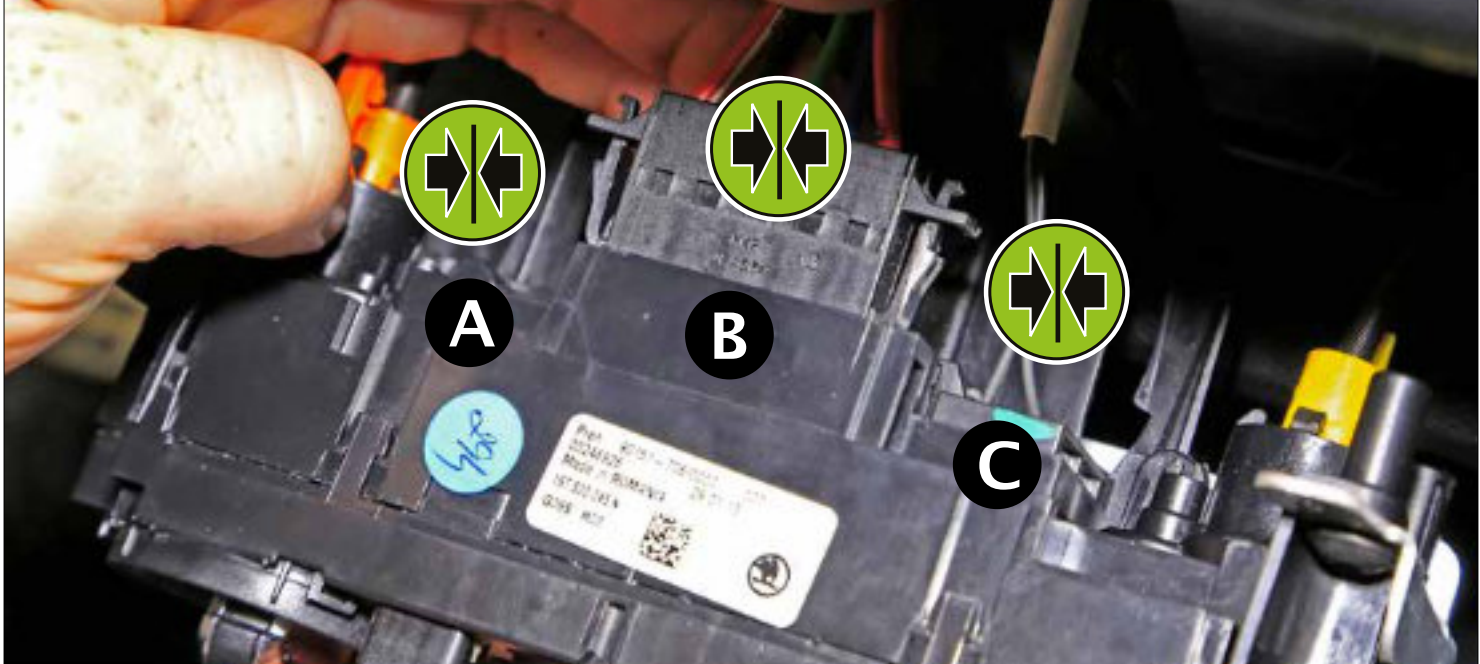

Attach the air condition control unit with 2 self-tapping screws with collar (pos. 11)

 2 x

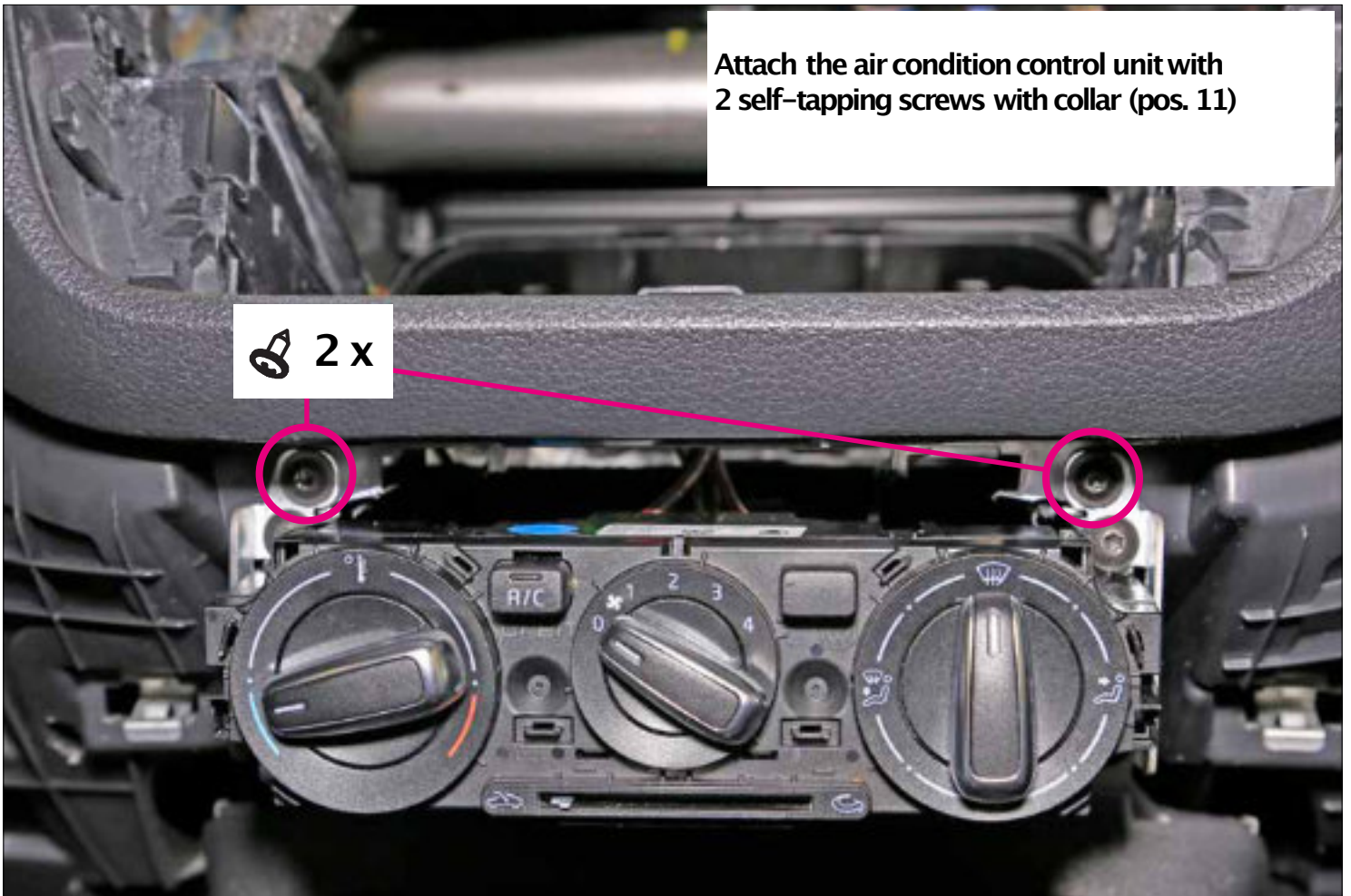

Push the panel around the centre console.

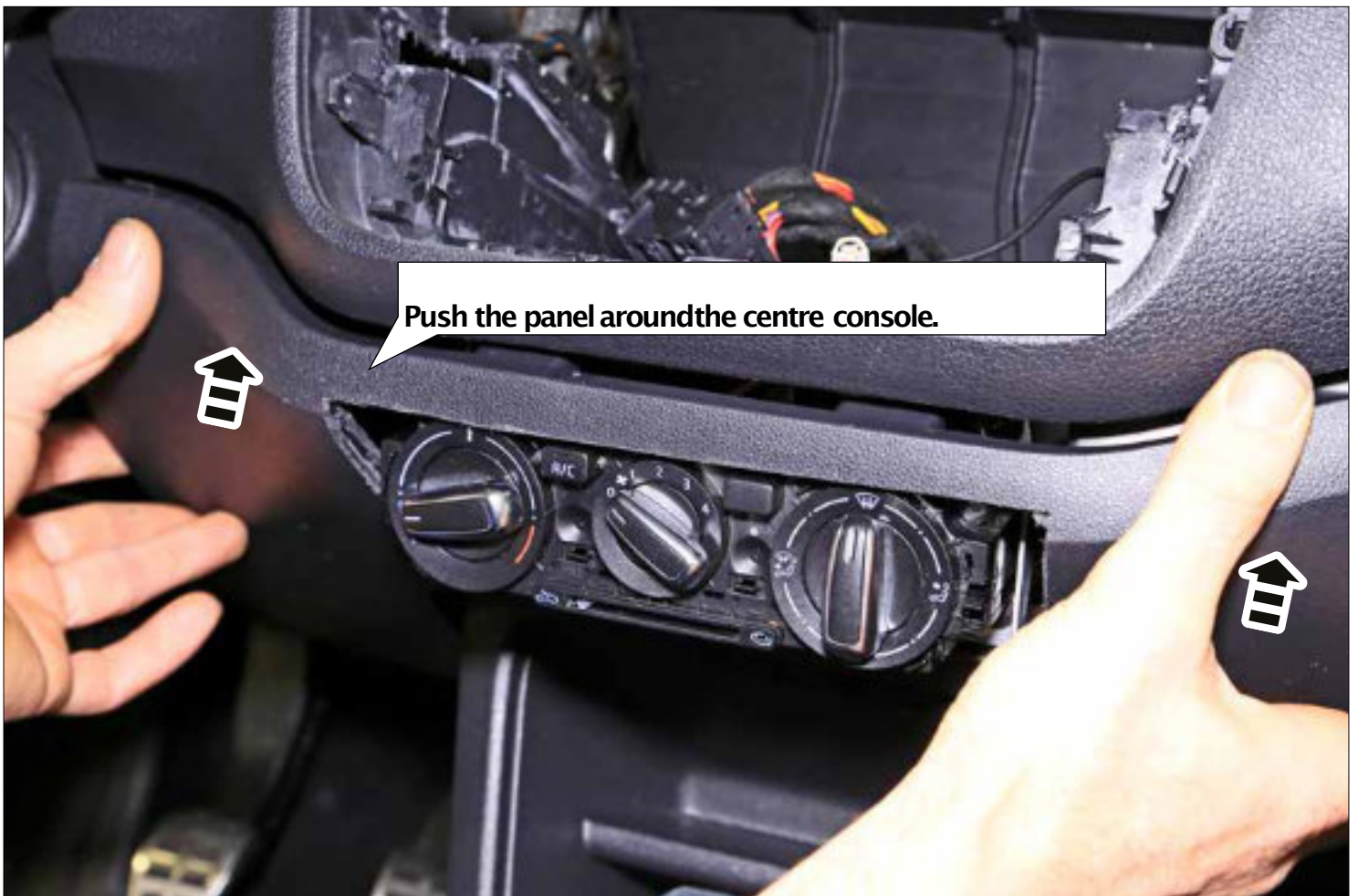



Fix the fascia (pos. 5) on the bottom side with the flat headed screw (pos. 10) and disk (pos. 9)





If a double DIN head unit without CD/DVDdrive (mechless unit / maximal install depth 140 mm) is going to be installed, the next steps can be skipped: Please proceed to page 35.

Separate top and bottom of the air channel (see arrows)



Bottom of the air channel



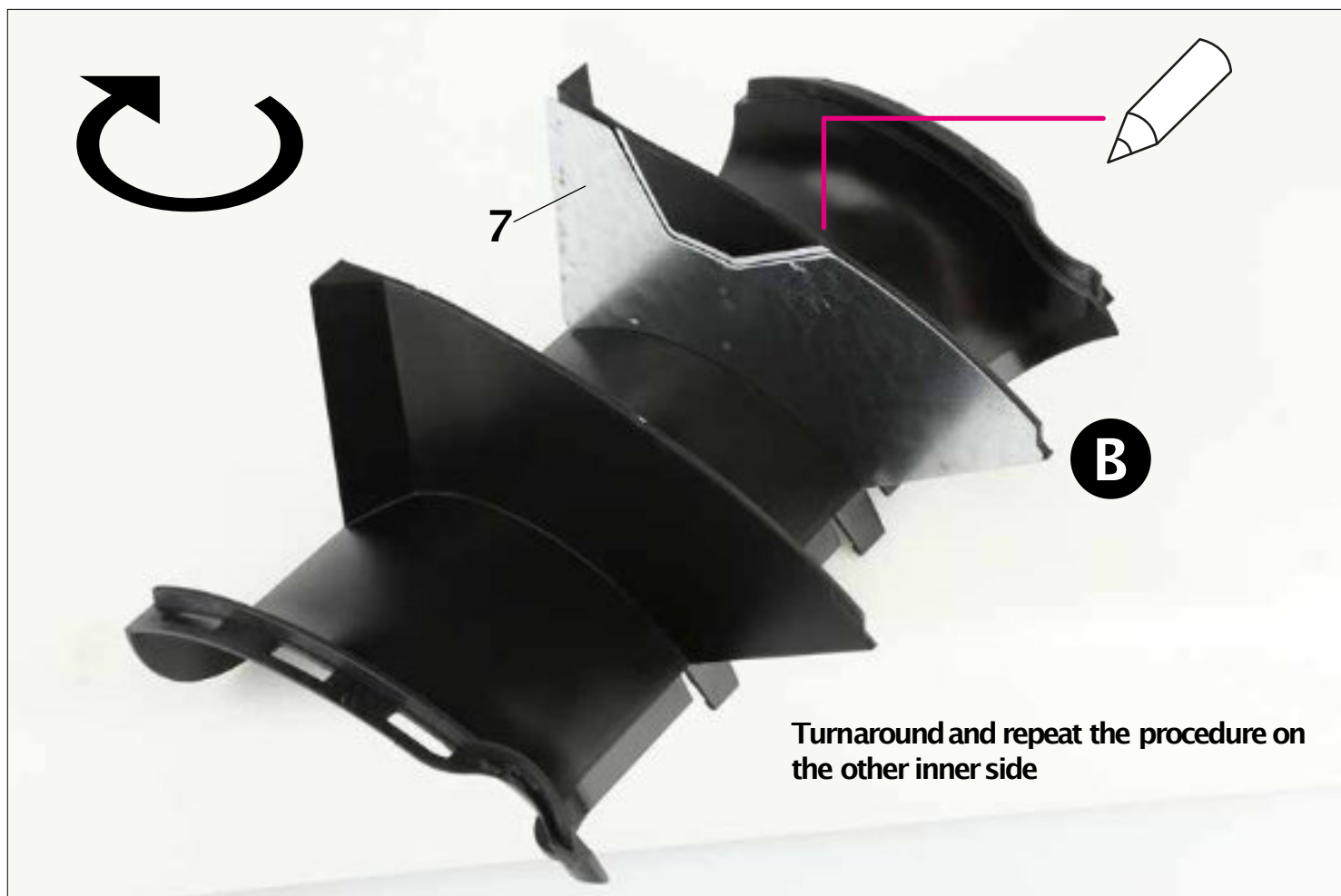
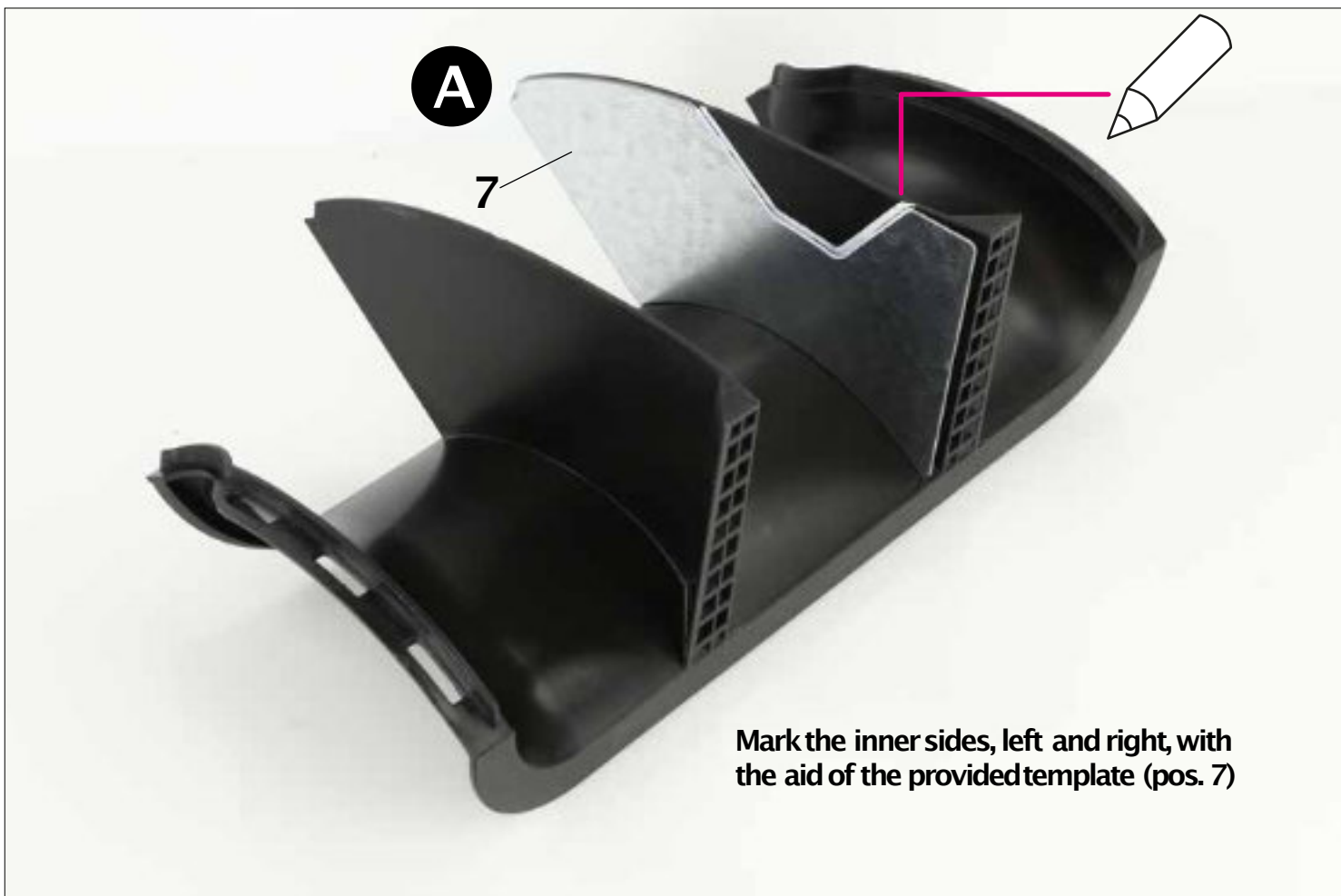



**View of the air channel
after after cutting**

New connection piece ahead of airchannel



Press top and bottom part together using a pincer (see arrows) until they snap in





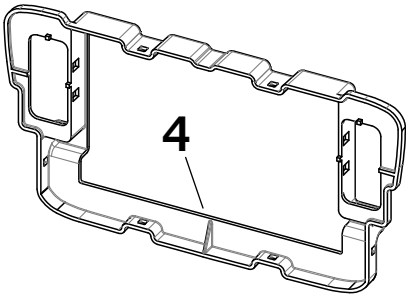
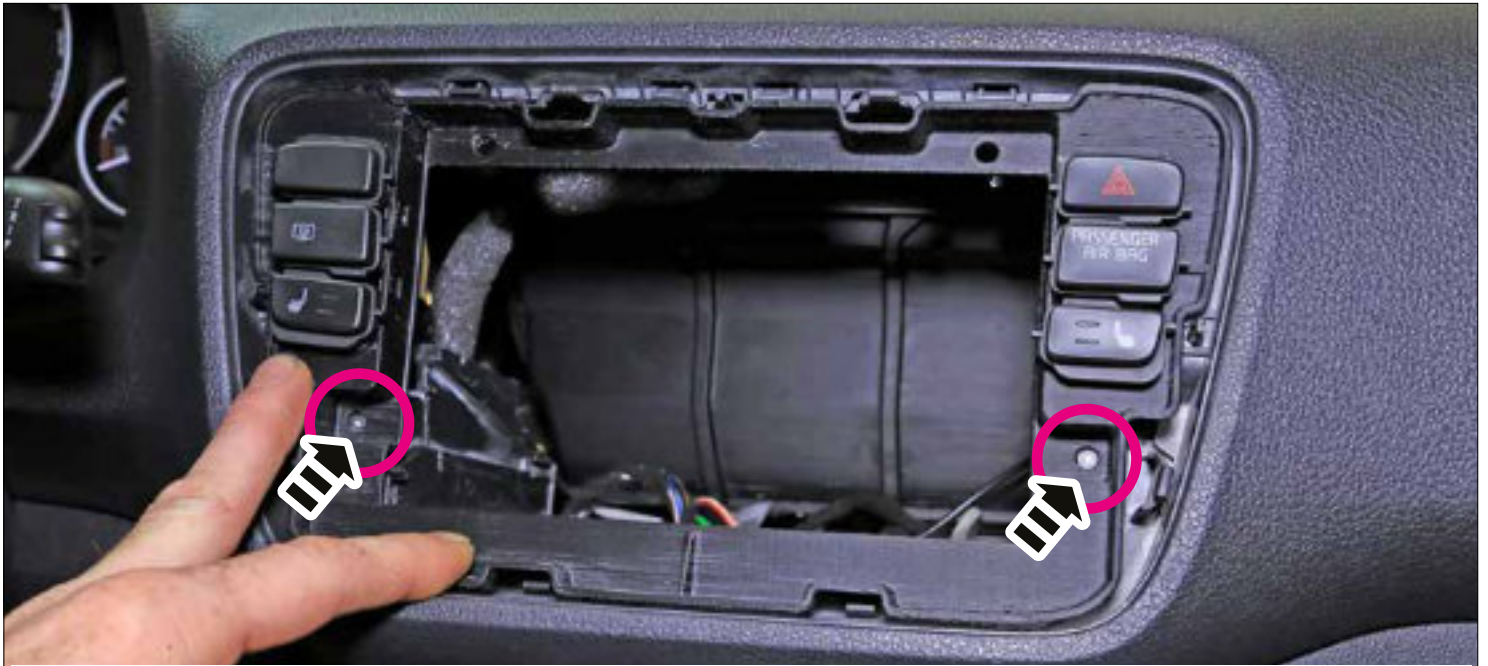

Place the mounting frame (pos. 4) over the radio opening and mark the position of the two drill holes (see arrows)

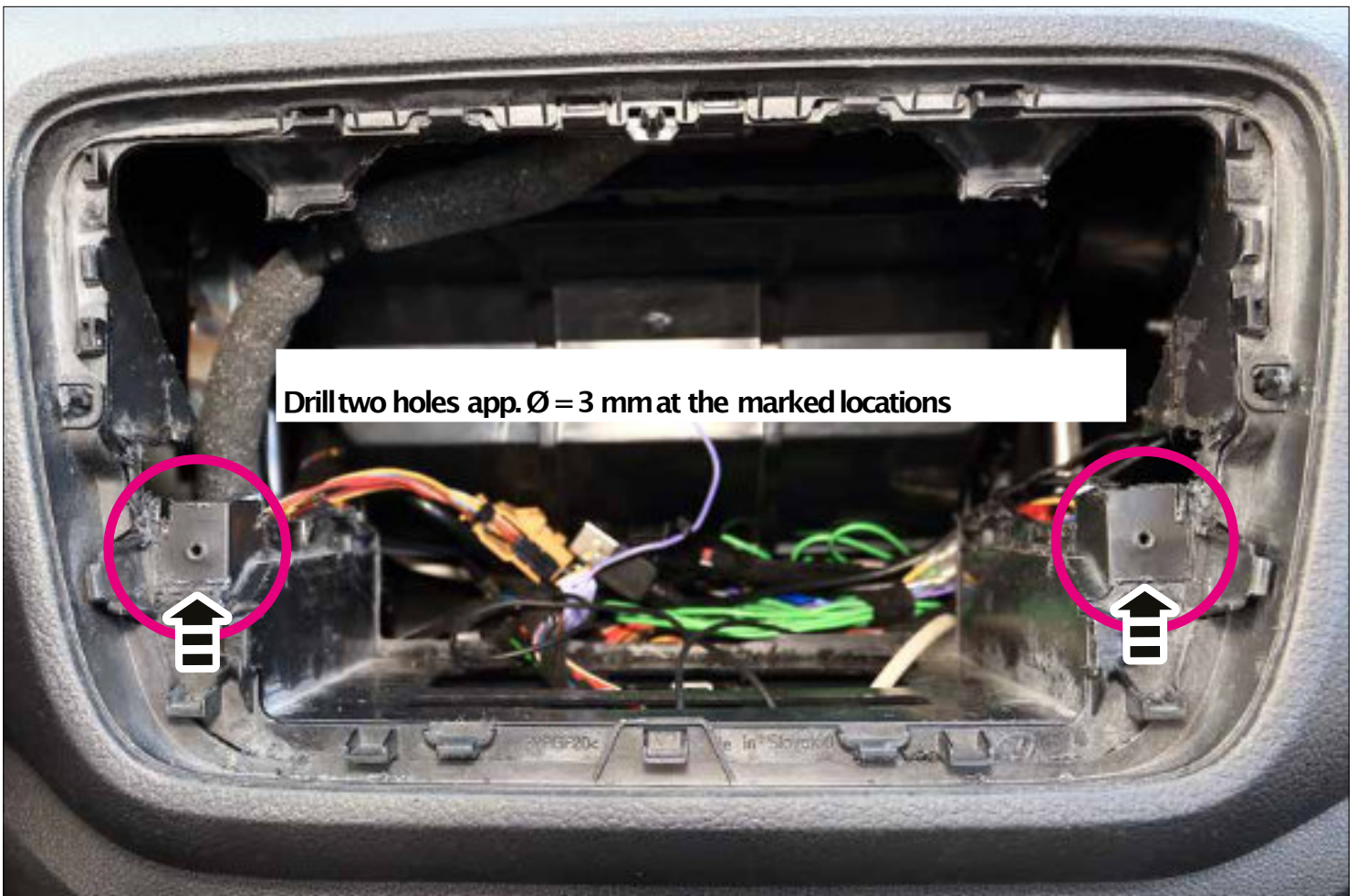

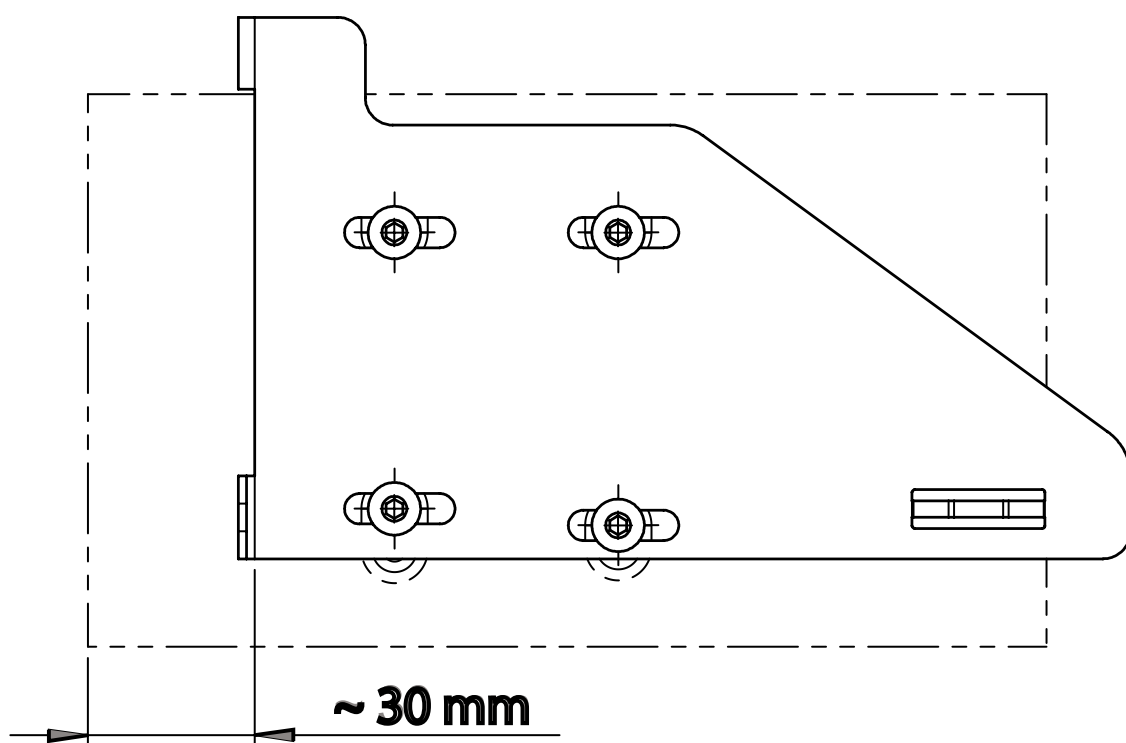
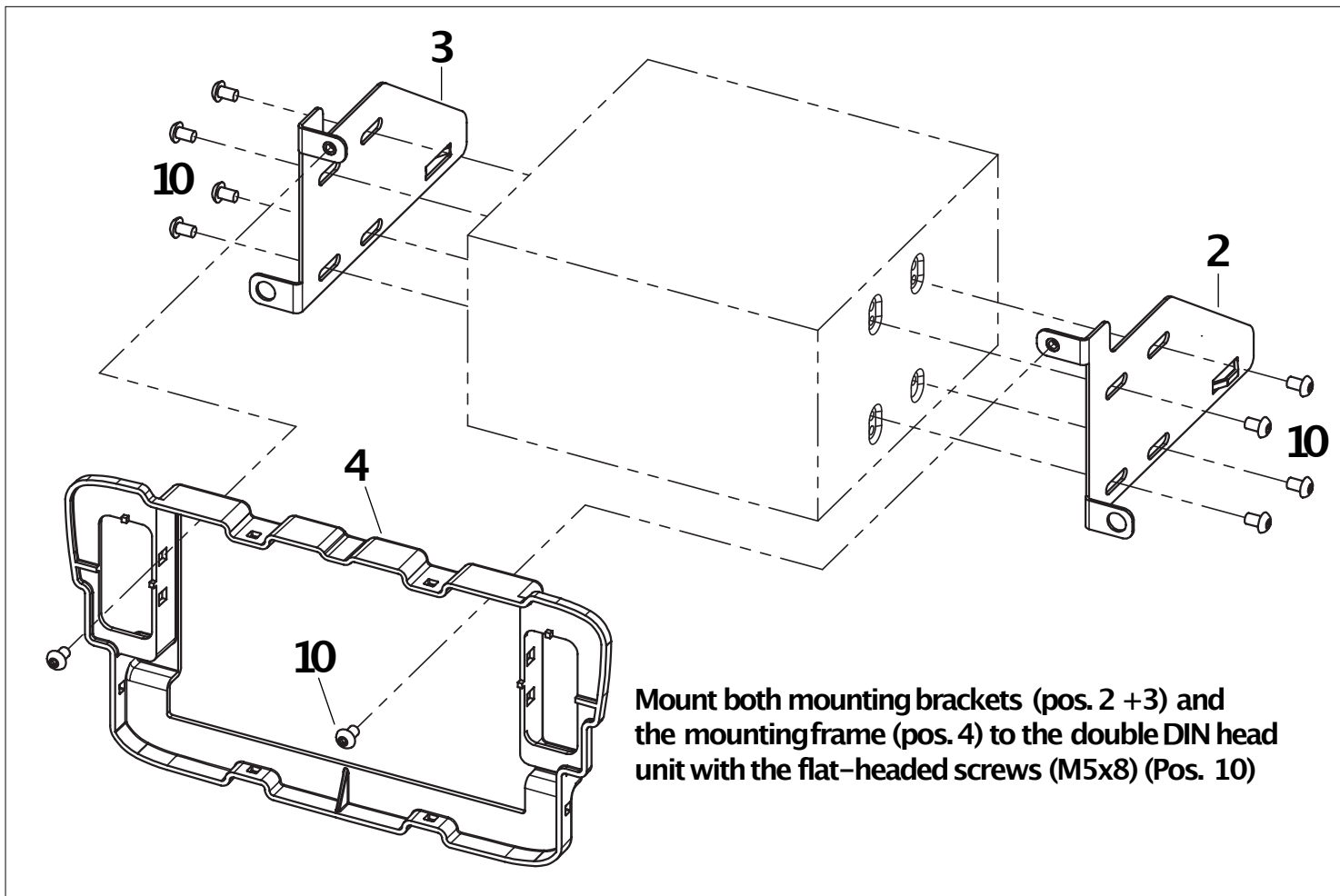

We recommend a distance of approx. 30 mm from the brackets to the front side of the unit

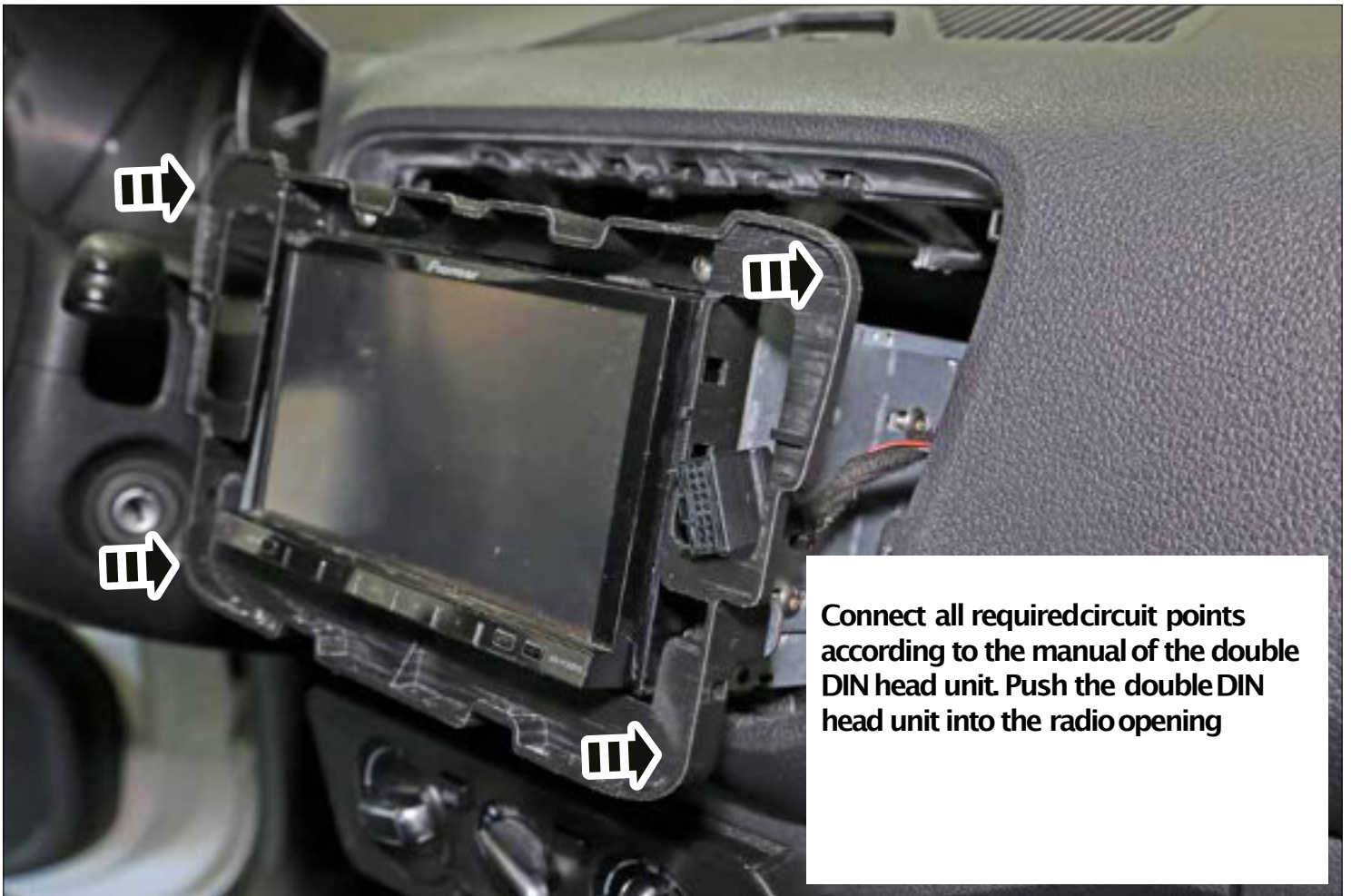

Connect all required circuit points according to the manual of the double DIN head unit. Push the double DIN head unit into the radio opening



Connect the left switch panel with the designated connector

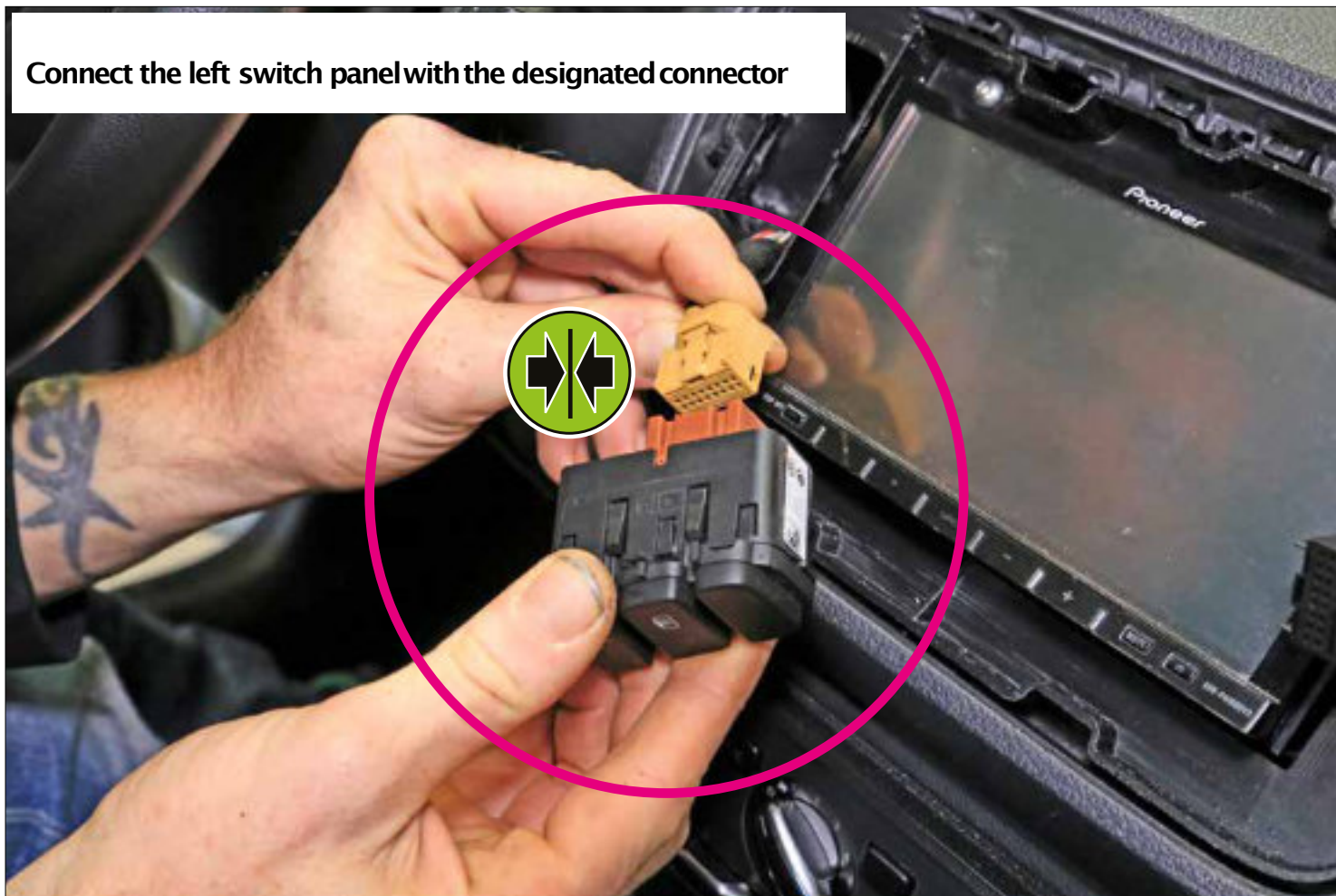

Place the left switch panel into the mounting frame



Connect the right switch panel with the designated connector



Place the right switch panel into the mounting frame



Attach the mounting frame (pos. 4) with 2 OEM screws (TorxTX 20)*
* see page 4 -upper image



Place the fascia plate (pos. 1) onto the mounting frame





