

USER MANUAL

Model FP9670

TO SUIT TERRITORY

SZ MK2

Inclusions

- 1x Black (Piano) double DIN facia kit
- 1x Built-in HVAC & steering wheel control unit
- 1x Universal SWC patch lead
- 1x Subwoofer retention
- 1x Antenna adapter
- 1x Chime retention
- 1x Mounting kit

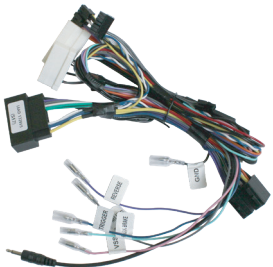
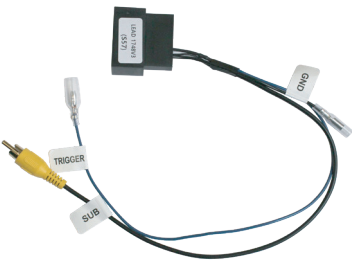
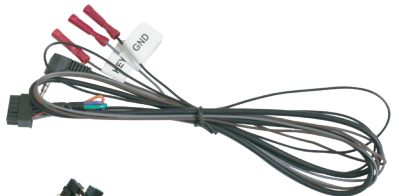
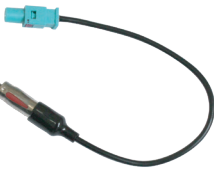
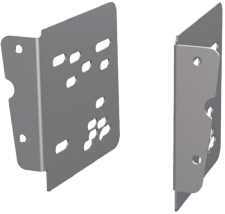

Infodapter Controls

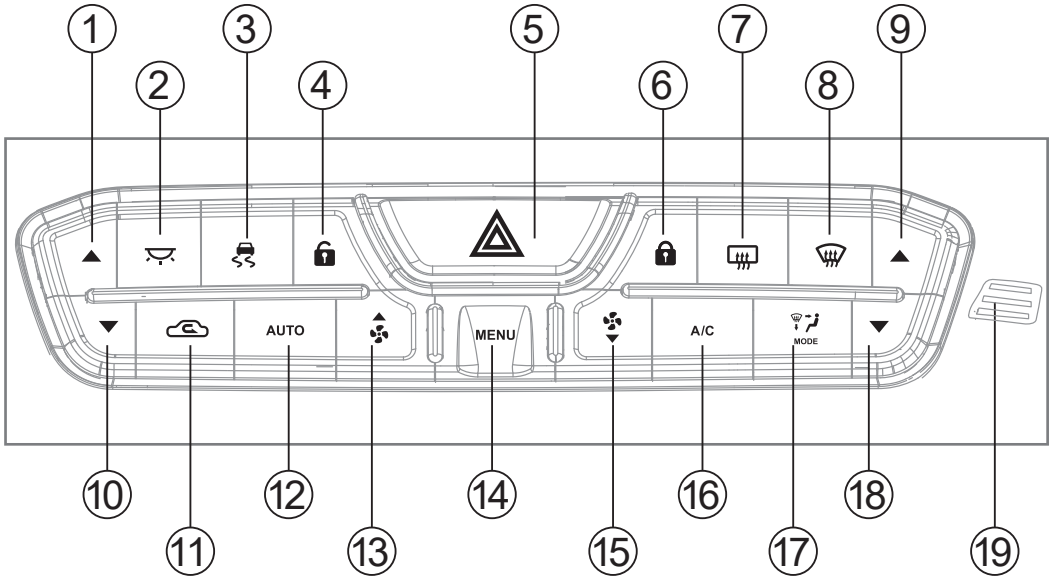

Steering Wheel Controls

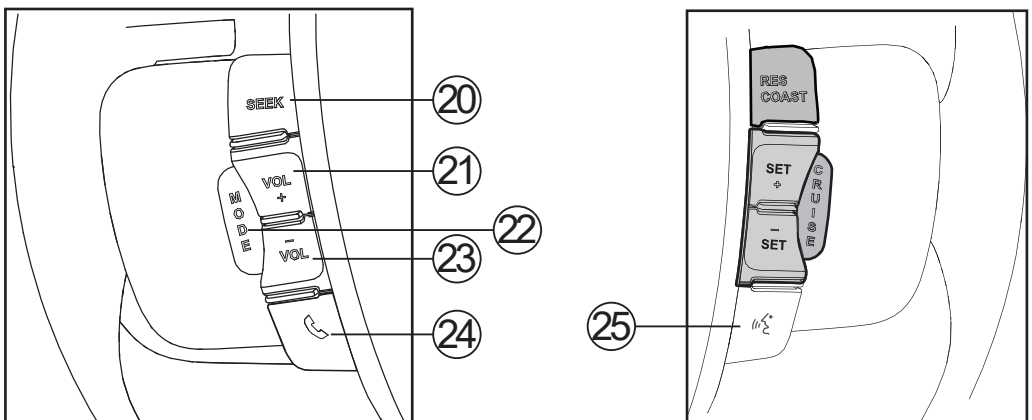

Button Functions

- | | | |
|---|--|---|
| 1. Temperature UP
(Passenger side) | 9. Temperature UP
(Drivers side) | 17. Mode |
| 2. Interior light ON/OFF | 10. Temperature DOWN
(Passenger side) | 18. Temperature DOWN
(Drivers side) |
| 3. Dynamic stability
control ON/OFF | 11. Air circulation | 19. Temperature Sensor |
| 4. Door unlock | 12. Auto climate control | 20. Seek |
| 5. Hazard button | 13. Fan speed | 21. Volume UP |
| 6. Door lock | UP/ Menu Navigation | 22. Mode |
| 7. Rear demister
(Push & hold for
parking aid activation
and deactivation) | 14. System menu | 23. Volume Down |
| 8. Front demister | 15. Fan speed
DOWN / Menu Navigation | 24. Phone (No longer retained) |
| | 16. Air conditioner
ON/OFF | 25. Voice Command button
-Short press to answer.
-Long press to hang up |

NOTE: *The voice command button has be re-assigned to answer and hang up calls*

NOTE: The Infodapter video output is NTSC by default.

Interface Functions

Front Demister

Fresh air is blown through the heater core and then ducted to and distributed over the interior surface of the vehicles windshield

BUTTON



SCREEN DISPLAY

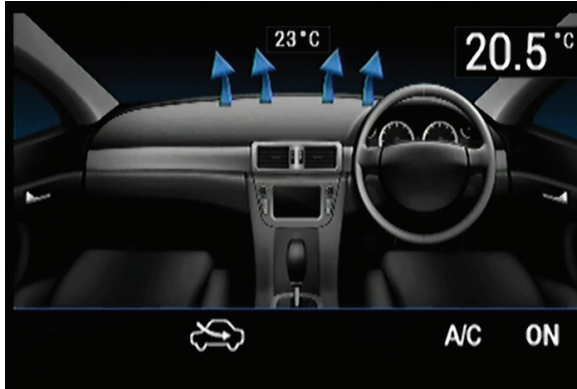

MFD



Rear Demister

The demister clears condensation from the rear window

BUTTON

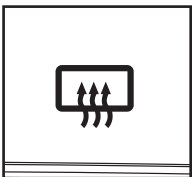

SCREEN DISPLAY



MFD

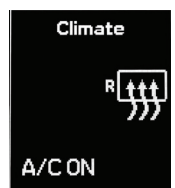

Push & Hold
to activate and
deactivate
parking aid



Interface Functions

Air Circulation Mode

Changes between fresh air drawn in directly from the outside of the vehicle, or recirculation where the air is drawn from inside the cabin

BUTTON



SCREEN DISPLAY



MFD

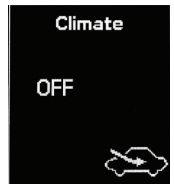

Interface Functions

Mode

Changes the vent positions for heating and cooling

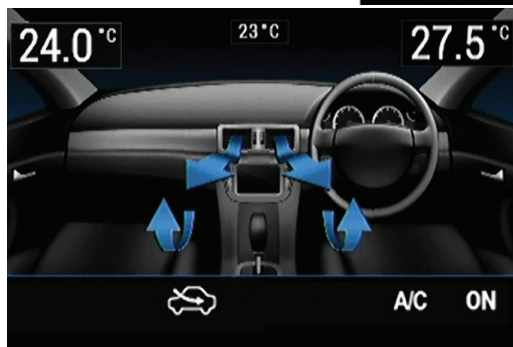
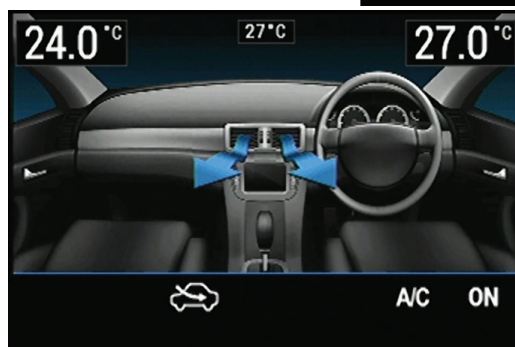
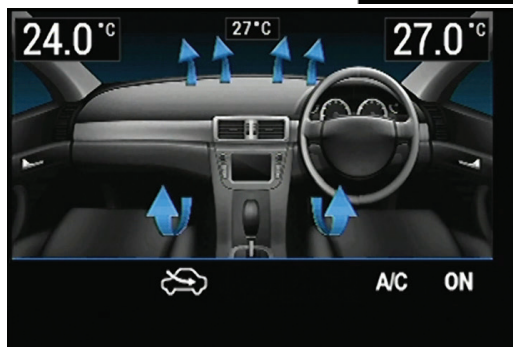
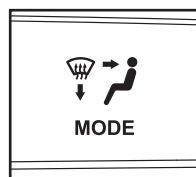

Interface Functions

Heating & Cooling Temperature

To increase temperature press up, to decrease temperature press down. Left hand side buttons adjust passenger side temperature settings. Right hand side buttons adjust drivers side temperature settings. Push & hold the **Auto** button to reset back to single zone. External temperature icon is in the top middle

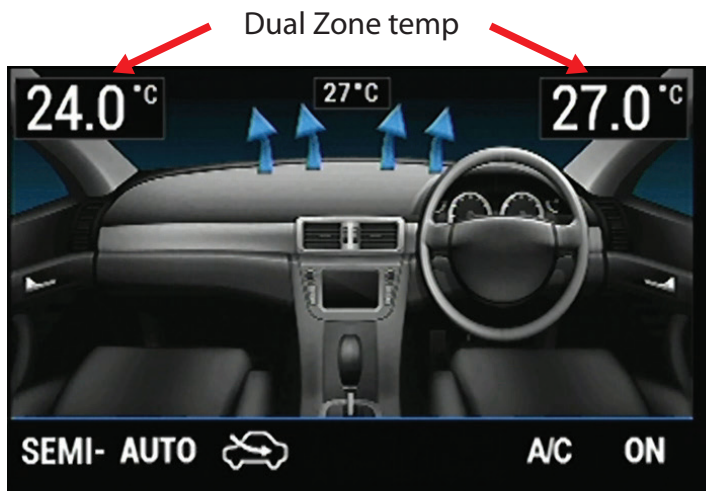
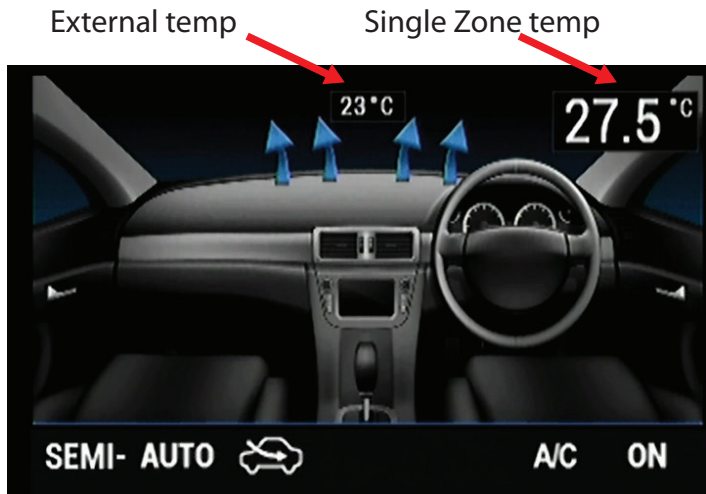
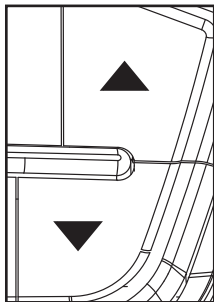

Interface Functions

Air conditioning On or Off

Press to turn the air conditioning On/Off or vice versa. This can be changed and reversed in the setup menu. **Note:** *Holding down the A/C button completely turns the A/C heating and cooling system Off.*

BUTTON

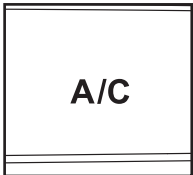

SCREEN DISPLAY



MFD

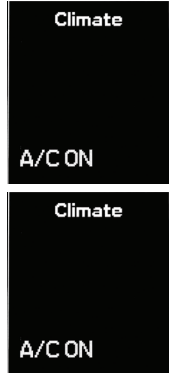

Fan Speed Adjustment

Pressing these will turn the fan speed up and down. **Note:** *Adjusting fan speed will also switch from auto to semi-auto climate control.*

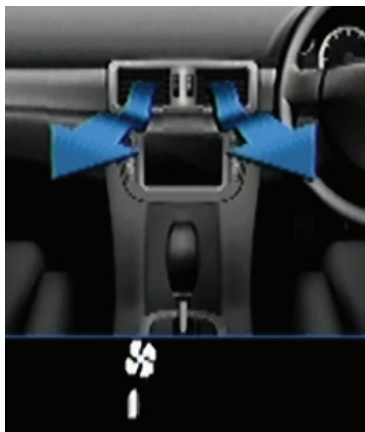
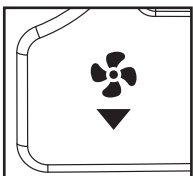
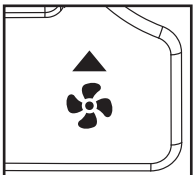

Interface Functions

Auto Function

Press to automatically set the climate control to maintain a specified temperature.

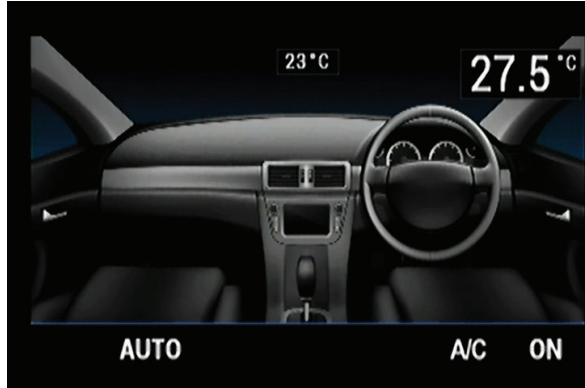

Auto Function (Semi Auto)

Adjusting the fan speed will also switch from auto to semi-auto climate control.

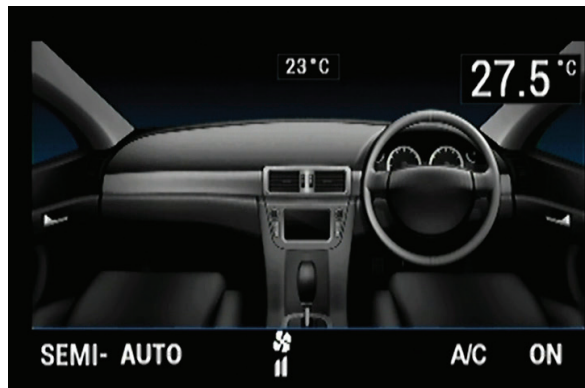

Interface Functions

Door Unlock/Lock

Press to lock and unlock all doors in the vehicle

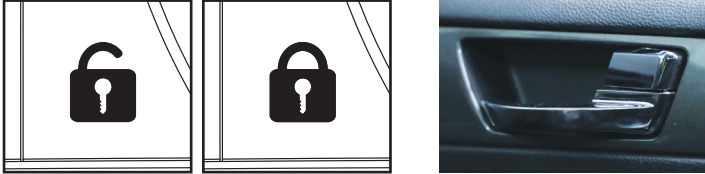

Dynamic Stability Control

Press to turn Dynamic Stability Control (vehicles traction control) on or off.



Interior Light

Press to turn the vehicles factory interior light on or off

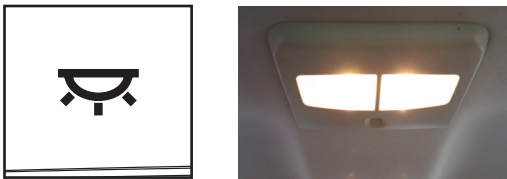

Hazard Flasher Warning Light

Press to turn the vehicles hazard emergency light on or off



Menu Functions

Configuration Menu

Press and hold the menu button for a few seconds to display the Configuration Menu. Press the Fan UP/DOWN buttons to navigate up and down between sub menus. Press menu button to enter into sub menus and again to change settings.

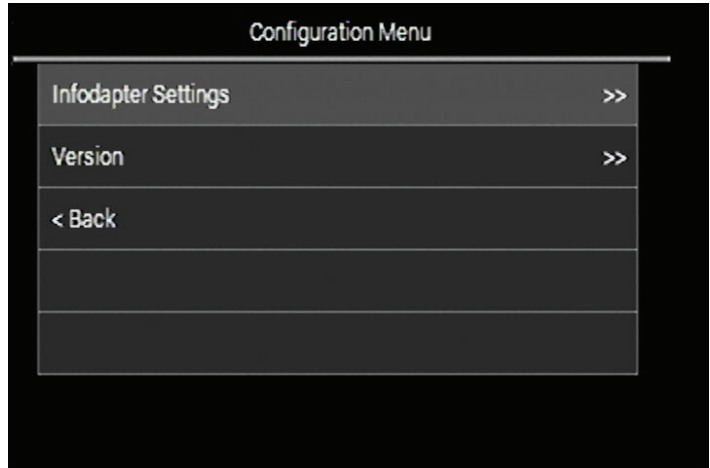
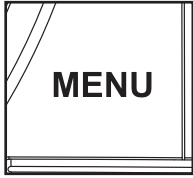

Menu Functions (Infodapter Settings)

Select Infodapter Settings/Preferences to access sub menus.

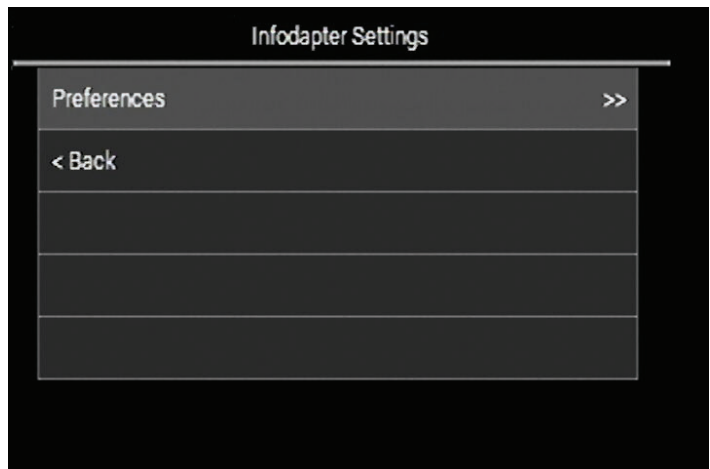

Menu Functions (Infodapter Settings Continued)

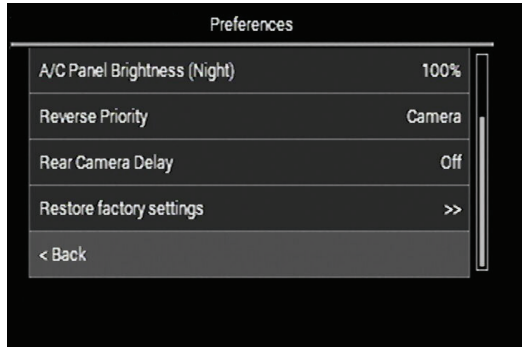
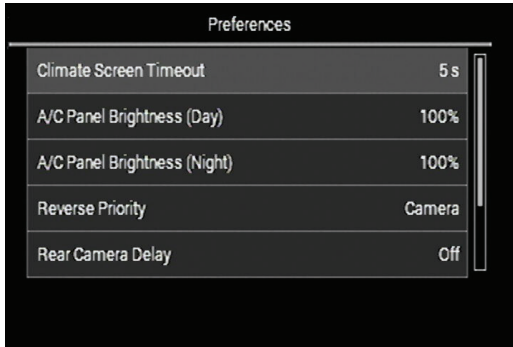

Climate Screen Timeout

Adjusts the time it takes the Infodapter screen to return to the Headunit Screen, by pressing the fan Up & Down buttons, select between 3 - 30 seconds

A/C Panel Brightness (Day mode)

Adjusts the brightness of the LED's on the Infodapter, by pressing the fan Up & Down buttons, select between 5% - 100%

A/C Panel Brightness (Night mode)

Adjust the brightness of the LED's on the Infodapter, by pressing the fan Up & Down buttons, select between 5% - 100%

Reverse Priority

Allows the selection of either the camera video feed or the park assist image when the vehicle is in reverse. Switchable via steering wheels **MODE** button. (Only appears in the menu if the camera connection setting is turned ON)

Rear Camera Delay

The camera image is displayed upon shifting out of Reverse (R) until the vehicle speed reaches 8 km/h. This occurs when the rear camera delay feature is on.

Restore Factory Settings

Restore all infodapter settings to default

Menu Functions (Infodapter Settings)

Installer Menu

When in the Configuration menu, press and hold the fan **UP & DOWN** buttons at the same time to access the installer menu

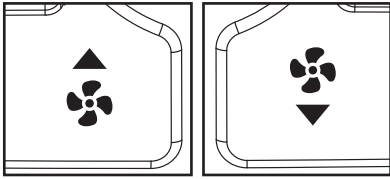

Air Conditioner Type

Choose between a single or dual climate system. *Note: Dual climate systems can run as a single zone system*

Menu Functions (Infodapter Settings)

Screen Size/ Position

Allows the user to change the Infodapter screen to fit to your headunits display

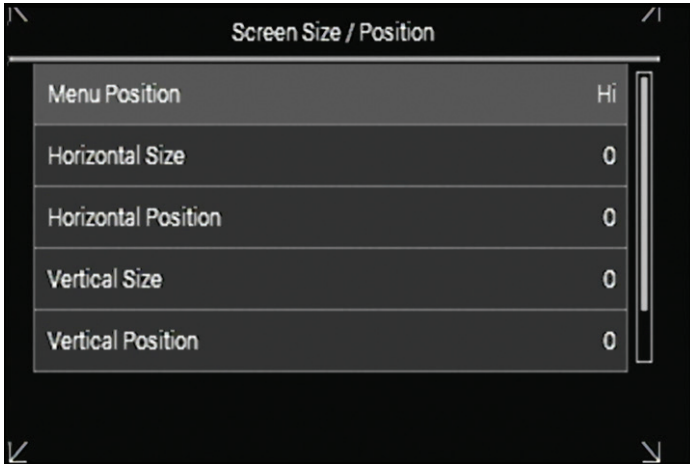

Camera Connected

Turns the reverse camera function On or Off. **Note:** must be set to “Yes”

Diagnostics

Information on the system to check the vehicle is communicating with the Infodapter

